

**nzsee**  
NEW ZEALAND SOCIETY FOR  
EARTHQUAKE ENGINEERING

 **MINISTRY OF BUSINESS,  
INNOVATION & EMPLOYMENT**  
HIKINA WHAKATUTUKI



**NZCS** | New Zealand  
Concrete Society

**EQC**  
EARTHQUAKE COMMISSION  
Kōwhiriwhiri Kōwhiriwhiri

 **Quake Centre**  
Delivering Industry Solutions

# Guideline for the Design of Seismic Isolation Systems for Buildings

JUNE 2019  
DRAFT FOR TRIAL USE

# IMPORTANT NOTICE

This document is a preliminary version issued for trial use and industry comment. Submissions by practitioners to the editors are encouraged. The contents may be subject to further changes, additions, and deletions.

The latest version is available from the NZSEE website:

[www.nzsee.org.nz/publications/design-of-seismic-isolation-systems-for-buildings](http://www.nzsee.org.nz/publications/design-of-seismic-isolation-systems-for-buildings)

## © Copyright

The copyright owner authorises reproduction of this work, in whole or in part, so long as no charge is made for the supply of copies, and the integrity and attribution of the contributors and publishers of the document is not interfered with in any way.

Description of stage	Version No.	Published
Draft for trial use	1.0	June 2019

# ACKNOWLEDGEMENTS

This guideline was initiated by the New Zealand Society for Earthquake Engineering (NZSEE).

## **Funding was provided by the following organisations:**

Ministry of Business, Innovation and Employment

Earthquake Commission

New Zealand Society for Earthquake Engineering Inc

Structural Engineering Society New Zealand Inc

New Zealand Concrete Society

## **Principal authors:**

David Whittaker, Beca (joint project lead)

Will Parker, WSP-Opus (joint project lead)

Didier Pettinga, Holmes Consulting

Dario Pietra, WSP-Opus

Graeme McVerry, GNS Science

Geoff Sidwell, Aurecon

Alistair Cattanach, Dunning Thornton

Andrew Charleson, Independent consultant

Weng Yuen Kam, Beca

## **Delivery support from UC Quake Centre**

The contribution of time and expertise from all those involved is gratefully acknowledged.

## **Disclaimer**

The material contained in this document is intended as a guideline only.

While the authors have taken care in preparing this document, it is only a guide and, if used, does not relieve any person of the obligation to consider any matter to which that information relates, according to the circumstances of the case. All readers should satisfy themselves as to the applicability of the recommendations made and should not act on the basis of any matter contained in this document without considering, and if necessary taking appropriate professional advice on, their own particular circumstances. The publishers, editor and contributors expressly disclaim all and any liability to any person in respect of anything done or omitted to be done by any such person in reliance upon the whole or any part of the contents of this document.



# TABLE OF CONTENTS

<b>Preface .....</b>	<b>12</b>
<b>1. 1. Introduction .....</b>	<b>13</b>
1.1 Purpose and scope.....	14
1.2 Building Code compliance .....	15
1.3 Peer review .....	15
1.4 Determination of earthquake actions.....	15
1.5 Limit states .....	15
1.6 Outline of this document .....	16
Commentary .....	17
<b>2. Isolated building system and design philosophy.....</b>	<b>21</b>
2.1 Overview.....	22
2.2 Criteria for each isolated building type .....	22
2.3 Structural performance factor ( $S_p$ ) and force reduction factor ( $k_\mu$ ).....	23
2.4 Components of an isolated building and their functions.....	23
2.5 Building component design requirements .....	26
Commentary .....	28
<b>3. Building performance.....</b>	<b>33</b>
3.1 Overview.....	34
3.2 Low damage design .....	34
3.3 Performance objectives .....	34
3.4 Performance criteria .....	36
3.5 External factors .....	37
3.6 Instrumentation and monitoring .....	37
Commentary .....	38
<b>4. Seismic hazard spectra and ground motions.....</b>	<b>41</b>
4.1 Overview.....	42
4.2 Acceleration and displacement seismic demands.....	42
4.3 Site-specific hazard studies .....	46
4.4 Selection and scaling of ground motion records.....	47
4.5 Conditional mean and conditional spectra methods.....	48
4.6 Commentary .....	49

<b>5. Analysis requirements and methods .....</b>	<b>55</b>
5.1 Overview.....	56
5.2 Selecting the analysis method .....	56
5.3 General requirements.....	57
5.4 Single degree of freedom analysis of the isolation system.....	58
5.5 Equivalent static analysis of the superstructure.....	62
5.6 Modal response spectrum analysis.....	66
5.7 Numerical integration time history analysis .....	68
5.8 Analysis of part of a building, and floor response spectra.....	70
Commentary .....	71
<b>6. DESIGN .....</b>	<b>77</b>
6.1 The design process .....	78
6.2 Structural performance factor $S_p$ .....	78
6.3 Superstructure ductility .....	78
6.4 Capacity design of the superstructure.....	78
6.5 Bounding isolator property variability .....	79
6.6 Structural elements for isolator stability .....	79
6.7 Design criteria and procedures for each isolated building type.....	82
Commentary .....	93
<b>7. Detailing at the isolation plane .....</b>	<b>107</b>
7.1 Transfer structures .....	108
7.2 Access to isolators (crawl space) .....	108
7.3 Isolator attachment, installation and removal .....	108
7.4 Temporary restraint during construction.....	108
7.5 Durability .....	108
7.6 Fire protection.....	108
7.7 Design for access and egress .....	108
7.8 Building services and utilities .....	108
Commentary .....	109
<b>8. Specification for procurement of isolation systems and isolators .....</b>	<b>117</b>
8.1 General.....	118
8.2 Quality assurance .....	118
8.3 Supplier submittals .....	119
Commentary .....	121

<b>9. Inspection and maintenance .....</b>	<b>123</b>
9.1 General.....	124
9.2 Warning signage.....	124
9.3 Maintenance manual .....	124
9.4 Displacement recorders.....	124
9.5 Inspection and maintenance programme .....	124
Commentary .....	126
<b>References and bibliography .....</b>	<b>127</b>
<b>Appendix A - Definitions and abbreviations .....</b>	<b>131</b>
<b>Appendix B - Notation .....</b>	<b>133</b>
<b>Appendix C - Sample specification for seismic .....</b>	<b>page 137</b>
<b>isolation system components</b>	

# FIGURES

<b>Figure 2-1:</b> Components of a seismically isolated building.....	24
<b>Figure 2-2:</b> Illustration of typical seismic actions (forces and displacements) to be considered for stability and equilibrium.....	25
<b>Figure 4-1:</b> Displacement spectral shape factors $\Delta_h(T)$ for the site subsoil classes and corner periods .....	45
<b>Figure 4-2:</b> $\Delta_h(T)$ - $C_h(T)$ plots for the site subsoil classes and corner periods .....	46
<b>Figure 4-3:</b> Determining TL from intersection of $SD_{max}$ and $SV_{max}$ envelopes .....	50
<b>Figure 5-2:</b> Calculation of system damping for a generic isolation system .....	59
<b>Figure 5-1:</b> Seismic isolation system SDOF capacity and ADRS demand curves .....	59
<b>Figure 5-4:</b> Linearisation procedure for typical isolators.....	60
<b>Figure 5-3:</b> Scaling of ADRS curve .....	60
<b>Figure 5-5:</b> Vertical distribution of lateral forces (York and Ryan, 2008) .....	65
<b>Figure 5-6:</b> Application of damping to the isolated mode for MRSA analysis.....	68
<b>Figure 5-7:</b> Rayleigh or proportional damping model .....	69
<b>Figure 6-1:</b> Case 1 – ULS non-seismic loads, no seismic deflection .....	79
<b>Figure 6-2:</b> Case 2 – ULS vertical loads, residual deflections .....	80
<b>Figure 6-3:</b> Case 3 – Design earthquake deflections and actions on the isolator and adjacent structural stability elements (for ULS and CLS limit states).....	80
<b>Figure 6-4:</b> Geometrical modelling of elastomeric isolator .....	81
<b>Figure 6-5:</b> Geometrical modelling of curved surface slider isolator .....	81
<b>Figure 6-6:</b> Geometrical modelling of flat slider isolator.....	81
<b>Figure 6-7:</b> Isolation plane design flowchart .....	82
<b>Figure 6-8:</b> Default upper and lower bound multipliers for ‘unknown’ manufacturers (from ACSE 7-2016 Chapter C17) .....	100
<b>Figure 6-9:</b> Default upper and lower bound multipliers for ‘quality’ manufacturers (from ACSE 7-2016 Chapter C17) .....	100
<b>Figure 7-1:</b> The use of transfer structures can reduce the number of bearings .....	108
<b>Figure 7-2:</b> A typical installation arrangement for attachment bolts .....	109



**Figure 7-3:** Position of flat jack..... 109

**Figure 7-4:** Sections through a lift shaft showing how it hangs from the superstructure and is braced back to it. Also showing seismic gaps..... 112

**Figure 7-5:** A section showing a steel cover plate connected to the isolated structure..... 113

**Figure 7-6:** A cantilever slab covering the rattle space and the necessary clearances ..... 113

**Figure 7-7:** A moat covered by a precast concrete slab ..... 113

**Figure 7-8:** Three generic types of cover plates for floors that allow horizontal movement in any direction. Fire blankets and other necessary construction details are not shown..... 114

**Figure 7-9:** A wall movement joint that allows movement in both horizontal directions ..... 115

**Figure 7-10:** Methods for achieving flexible connections for the design displacements between the isolated superstructure and fixed elements like retaining walls..... 116

**Figure 7-11:** Separation of a partition wall below the isolation plane from the isolated structure above ..... 116

# TABLES

<b>Table 2-1:</b>	Criteria for isolated building Types 1 to 4 .....	22
<b>Table 2-2:</b>	Isolation system robustness factor.....	25
<b>Table 2-3:</b>	Overview of common isolator types.....	28
<b>Table 2-4:</b>	Common bearing combinations used in New Zealand.....	30
<b>Table 3-1:</b>	Limit states, performance objectives and criteria for isolated buildings .....	35
<b>Table 3-2:</b>	Non-structural performance criteria for the damage control limit state (DCLS).....	37
<b>Table 4-1:</b>	Corner periods TL throughout New Zealand for assigned moment magnitude Mw .....	43
<b>Table 4-2:</b>	Displacement spectral shape factors.....	44
<b>Table 4-3:</b>	Suggested number of ground motion acceleration history records .....	48
<b>Table 5-1:</b>	Required methods of analysis .....	56
<b>Table 6-1:</b>	Design procedure for Type 1 isolated buildings.....	83
<b>Table 6-2:</b>	Design procedure for Type 2 isolated buildings.....	85
<b>Table 6-3:</b>	Design procedure for Type 3 isolated buildings.....	87
<b>Table 6-4:</b>	Design procedure for Type 4 isolated buildings.....	90
<b>Table 6-5:</b>	Limit state checks and corresponding bounding design and analysis cases .....	98
<b>Table 6-6:</b>	Default lambda factors for elastomeric isolators in absence of qualification data, from ASCE 7-16 (from McVitty and Constantinou, 2015).....	101
<b>Table 6-7:</b>	Comparison of ASCE 7-16 lambda factors for default and example cases for elastomeric isolators (from McVitty and Constantinou, 2015) .....	101
<b>Table 6-8:</b>	Default lambda factors for Friction Pendulum™ main sliding surface friction factor $\mu_1$ in absence of qualification data, from ASCE 7-16 (from McVitty and Constantinou, 2015) .....	102
<b>Table 6-9:</b>	Comparison of ASCE 7-16 lambda factors for default and example cases for Friction Pendulum™ isolators (from McVitty and Constantinou, 2015).....	102
<b>Table 6-10:</b>	Lambda values based on EN 15129:2009 .....	105
<b>Table 6-11:</b>	Typical design limits that can be applied for elastomeric isolator design checks .....	106
<b>Table 6-12:</b>	Typical design limits that can be applied for sliding surface isolator bearing stress design checks.....	106

**Table 7-1:** Categories of movement joint minimum performance for various limit states, movement joint locations, and performance verification methods ..... 111

**Table 7-2:** Definition of categories of damage to movement joints..... 111

**Table 9-1:** Type and frequency of inspections and items to be inspected ..... 125

## PREFACE

This document provides guidance for designing structures with seismic isolation and gives technical specifications for procuring seismic isolation systems and isolator devices.

It has been developed in response to the needs of practising engineers designing isolated buildings and also to Recommendations 66 to 69 from the Canterbury Earthquakes Royal Commission. Those recommendations included that the Ministry of Business, Innovation and Employment (MBIE) promote further knowledge and guidance regarding the use of low damage design (LDD) technologies, of which seismic isolation is an important and relatively mature technology in New Zealand.

This guideline is intended to be in accordance with the performance requirements of the New Zealand Building Code, Schedule 1 to the Building Regulations 1992 (the Building Code or NZBC) and New Zealand standards for structural design; in particular, NZS 1170.5:2004 (incorporating Amendment No.1 published September 2016). Structures with seismic isolation are currently designed as ‘alternative solutions’ as there are no relevant acceptable solutions or verification methods for demonstrating Building Code compliance.

The guidance is based on the application of NZS 1170.5 with necessary supplementary considerations for displacement-based design, additional energy dissipation provided by isolation, and consideration of low damage design objectives. The recommended design approaches are a mixture of displacement and force-based methods: the isolation system is designed using displacement-based methods, while the superstructure, substructure and foundation are designed using force-based methods. NZS 1170.5 seismic design parameters are recommended for each isolated building type, deriving design earthquake actions (displacements and loads) for the isolation system, superstructure and substructure.

This guideline has been reviewed by international experts in seismic isolation and is issued for trial use. It may be amended further following feedback from industry users including design practitioners and vendors of isolator devices. Other amendments may also be necessary to make this guideline consistent in approach and terminology with evolving practices for performance-based and low damage designs of buildings.

The document is currently arranged in text and commentary format typical of some New Zealand standards in anticipation that it may be issued as guidance by MBIE’s Chief Executive under Section 175 of the Building Act 2004 or cited in a verification method at a later date. At present, the language used is generally in the form of recommendations (e.g. ‘should’ and ‘may’) rather than mandatory requirements (e.g. ‘must’ or ‘shall’). This may change if the guideline’s status changes.

David Whittaker and Will Parker

April 2019



Where there is commentary for a particular section, this is indicated by the commentary icon. The corresponding commentary is included at the end of the chapter.

---



## CHAPTER CONTENT

## PAGE

1.1 Purpose and scope .....	14
1.2 Building Code compliance.....	15
1.3 Peer review .....	15
1.4 Determination of earthquake actions.....	15
1.5 Limit states.....	15
1.6 Outline of this document .....	16
Commentary .....	17

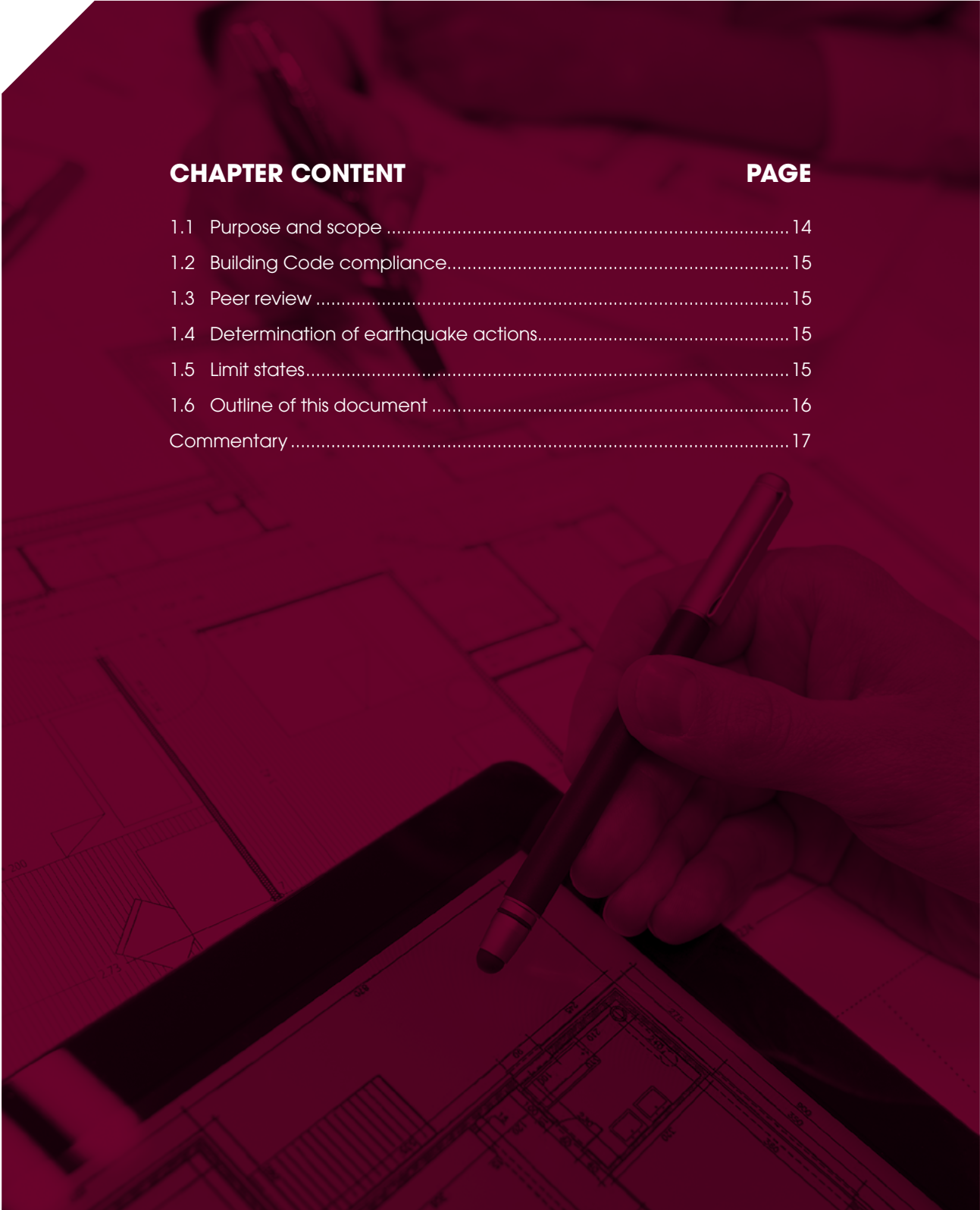

## 1.1 Purpose and scope

This guideline sets out the approach for establishing earthquake design actions to be used in the limit state design of structures incorporating seismic isolation in accordance with NZS 1170.5. It also provides the basis and parameters for which structures and elements are to be designed in accordance with material specific standards. It includes sample specifications for the procurement of isolator devices.

The guidance is applicable to the following types of isolators (or workable combinations of these):

- elastomeric including natural rubber (NRB), lead rubber (LRB) and high damping rubber (HDR) isolators
- flat slider (FS) isolators, when used in conjunction with other devices capable of providing displacement and adequate restoring force to the overall system
- curved surface slider (CSS) isolators, also known as ‘pendulums’ or ‘Friction Pendulums™’
- viscous damper (VD) units, when used in conjunction with other devices capable of providing adequate restoring force to the overall system
- other linear or nonlinear devices (for example yielding steel devices) that provide acceptable force-displacement characteristics including adequate restoring force to the overall system.

Base isolated buildings should be in accordance with one of the following isolated building types and follow the design process, criteria and structural analysis methods specified for that type:

<b>Type 1: Simple</b>	Low-rise regular structures, where the superstructure is designed for elastic actions and detailed for limited ductility.
<b>Type 2: General</b>	Generally conforming structural systems not meeting Type 1 criteria, where the superstructure can be designed for nominally ductile actions and detailed for limited ductility.
<b>Type 3: Complex or Ductile</b>	All structure types including complex layouts or those designed for ductility in the superstructure, where the total displacement demands are met by displacement in both the isolation system and superstructure. Full capacity design and ductile detailing of the superstructure is required.
<b>Type 4: Brittle</b>	Structures where the superstructure has no ductility capacity (i.e. is brittle) and is designed for elastic actions.

Detailed criteria and limitations for each type are provided in Chapter 2.

This guideline **excludes**:

- seismic isolation systems for non-structural elements, e.g. heavy plant, IT racks (refer to ASCE-7 and NZS 4219 and to proprietary product suppliers)
- bridges with seismic isolation (refer to NZTA Bridge Manual and Eurocode 8 Part II-Bridges Section 7 – Bridges with seismic isolation)
- irregular seismic isolation systems, e.g. at multiple isolation planes. These irregular systems should be analysed using rational methods validated with appropriate numerical and experimental data.

## 1.2 Building Code compliance

Design of buildings with seismic isolation should be considered as an alternative solution for the purposes of demonstrating compliance with the Building Code.

This guideline provides a methodology for seismic design of buildings with seismic isolation to assist designers in meeting the relevant Building Code performance requirements based on NZS 1170.5.

This guideline also recommends system performance objectives, where the designer should consider options that result in low damage performance exceeding the minimum Building Code requirements, and verification of performance at Code-prescribed limit states plus additional limit states for continued occupancy and robustness for collapse prevention (resilience).

## 1.3 Peer review

Applications for building consents for buildings with seismic isolation should be supported by independent peer review and a Producer Statement for Design Review (PS2).

## 1.4 Determination of earthquake actions

Earthquake actions (loads and displacements) for use with isolated structures should be generally in accordance with NZS 1170.5, as modified by the requirements of this guideline.

Isolator variability bounding should be considered in accordance with a recognised international standard or rational approach as part of the design of the isolation system and specification for isolator devices and their manufacture.

## 1.5 Limit states

Limit states for the design of isolated structures should include those listed below. Importance Levels (ILs) are as defined in AS/ NZS 1170.0:2002 and are based on building function and occupancy. The Importance Level dictates the return period of the earthquake event which needs to be considered for each performance level (as described in Chapter 3).

<b>SLS1</b>	Serviceability Limit State 1 in accordance with NZS 1170.5 for the Importance Level considered.
<b>SLS2</b>	Serviceability Limit State 2 in accordance with NZS 1170.5 for the Importance Level considered. (Note that for non-IL4 structures, i.e. structures without a post-disaster function, this is beyond the requirements of NZS 1170.5 and may be agreed with the owner as a target for operational continuity performance at an agreed level of earthquake shaking; not necessarily 1 in 500 years.)
<b>DCLS</b>	Damage control limit state is the level of damage which is easily and economically repairable. The return period and some of the specific performance requirements for this limit state can be chosen to suit the building owner's performance requirements. Designers should select or report on the level of earthquake shaking at which damage requiring repair would occur to the building structure, building fabric and secondary building elements.
<b>ULS</b>	Ultimate limit state in accordance with NZS 1170.5 for the Importance Level considered
<b>CAIS</b>	Collapse avoidance limit state at which collapse of the isolated structure is to be prevented with reasonable reliability. NZS 1170.5 requires that there should be a reasonable margin to prevent collapse in a 'rare' earthquake beyond the ULS demand. For an isolated building, this requires specific consideration of a greater isolation system displacement as well as consideration of how the system as a whole provides robustness to avoid collapse at a larger than ULS level of shaking (refer to Equation 4.6).

## 1.6 Outline of this document

This guideline contains the following chapters and appendices. If a section has associated commentary, this is indicated by the symbol  and commentary is included at the end of each chapter.

Key content is summarised below.

<b>Chapter 1: Introduction (this chapter)</b>	<ul style="list-style-type: none"> <li>• Lists the types of isolator this guideline applies to, defines four building types for seismic isolation design, sets out the limit states to be considered</li> <li>• Building Code compliance and need for peer review</li> </ul>
<b>Chapter 2: Isolated building system and design philosophy</b>	<ul style="list-style-type: none"> <li>• Summarises criteria for each building type</li> <li>• Describes the five components of an isolated building, how each should perform, and general design requirements</li> </ul>
<b>Chapter 3: Building performance</b>	<ul style="list-style-type: none"> <li>• Enables selection of performance objectives and criteria in addition to Building Code requirements, especially those relating to the reduction of damage and downtime</li> <li>• Introduces two building performance levels above 'Code minimum': 4 Star (minimum) and 5 Star (recommended)</li> </ul>
<b>Chapter 4: Seismic hazard spectra and ground motions</b>	<ul style="list-style-type: none"> <li>• Site hazard spectra for isolated structures which are supplementary to the existing NZS 1170.5 hazard spectra</li> <li>• Methods for determining displacement design spectra for increased level of equivalent viscous damping, both of which are more important for design of the isolation systems than for conventional structures</li> <li>• Additional hazard spectra parameters related to spectrum corner periods and for soft ground conditions, as these are considered especially important for isolated structures responding at long periods of vibration</li> <li>• Guidance for when isolation would not be suitable, e.g. for particular building characteristics or flexible ground conditions</li> <li>• Specification of design earthquake actions based on effective system properties (effective period and damping), regularity, specified structural performance factors and superstructure ductility factor</li> </ul>
<b>Chapter 5: Analysis requirements and procedures</b>	<ul style="list-style-type: none"> <li>• Sets out the structural analysis methods permitted for each of the four isolated building types (analysis outputs are used to design the superstructure and substructure)</li> <li>• Methods include single degree of freedom analysis and equivalent static analysis – these are normally suitable for preliminary design – plus modal response spectrum analysis and numerical integration time history analysis</li> </ul>
<b>Chapter 6: Design</b>	<ul style="list-style-type: none"> <li>• Links the design philosophy and performance criteria outlined in Chapter 2 with the analysis approaches in Chapter 5</li> <li>• Provides a flowchart and then detailed design tables for each building type</li> </ul>
<b>Chapter 7: Detailing at the isolation plane</b>	<ul style="list-style-type: none"> <li>• Establishes performance expectations for the isolation plane</li> <li>• Provides guidance and details for structure, secondary structure, lifts and plant</li> </ul>
<b>Chapter 8: Specification for procurement of isolation systems and isolators</b>	<ul style="list-style-type: none"> <li>• Recommendations for specifying isolators, including manufacture and testing in accordance with recognised international (ASCE or Eurocode) standards</li> </ul>
<b>Chapter 9: Inspection and maintenance</b>	<ul style="list-style-type: none"> <li>• Key components of the inspection and maintenance programme, including the need for client reports</li> </ul>
<b>Appendix A: Definitions and abbreviations</b>	<ul style="list-style-type: none"> <li>• Definitions and abbreviations used in this document in relation to isolated buildings</li> </ul>
<b>Appendix B: Notation</b>	<ul style="list-style-type: none"> <li>• Notation used in this document</li> </ul>
<b>Appendix C: Sample specification for seismic isolation system components</b>	<ul style="list-style-type: none"> <li>• Generic technical specification for procuring isolator systems and devices</li> </ul>



# COMMENTARY

Section	Commentary
1.1	<p data-bbox="331 360 657 394"><b>Purpose and scope</b></p> <p data-bbox="331 434 743 461"><b>Background to seismic isolation</b></p> <p data-bbox="331 472 1422 645">Seismic isolation, also known as base isolation, is a technology that has been in existence for several decades. To date, it has been used in various forms in around 100 structures in New Zealand. Lead rubber bearings (LRBs) are a technology invented in this country, when Bill Robinson and Ivan Skinner came up with the idea of inserting a lead plug in an elastomeric bearing to provide seismic energy dissipation. The first LRBs were installed under the William Clayton building in Wellington around 1978 and since then these have been the most widely used bearing type in New Zealand.</p> <p data-bbox="331 656 1422 826">In spite of this, New Zealand has not had a code of practice for the design of structures with isolation or for the supply and testing of isolator devices. There are no existing acceptable solutions or verification methods (means of compliance with the Building Code), standards or codes of practice that are directly applicable to isolated structures. Therefore, isolated structures are usually designed as ‘alternative solutions’, and building consent applications for such designs are normally supported by independent peer review and Producer Statements (PS2).</p> <p data-bbox="331 837 1422 1008">Seismic isolation works by inserting a flexible connection between the ground and the structure, usually with a mechanism to dissipate substantial seismic energy. This results in an overall system with a longer period of vibration and greater effective damping, leading to reduced structural response and base shear compared with a fixed base structure. Global system displacements are generally greater than the fixed base system due to the increased system flexibility, but this is offset by increased damping. The bulk of the displacement demand occurs in the flexible isolation system rather than the structure itself.</p> <p data-bbox="331 1019 1422 1249">Isolated structures are generally expected to provide superior seismic performance compared with that available from conventional structural systems. In general, isolated structures could be expected to provide a high level of damage avoidance performance, often well in excess of the minimum performance required by the Building Code or achievable from many conventional structural systems. This is possible because isolated structures are able to reduce both the accelerations (forces) imposed on the building superstructure, building fabric and contents, as well as inter-storey drifts in the superstructure. Under strong earthquake shaking most of the deformations can be directed into the isolation system rather than to the structure itself.</p> <p data-bbox="331 1261 810 1288"><b>Royal Commission recommendations</b></p> <p data-bbox="331 1299 1422 1417">Following the Canterbury earthquake sequence of 2010-11, the Canterbury Earthquakes Royal Commission published discussion and formal recommendations regarding low damage building technologies including base isolation. The Commission made the following Recommendations 66-69 in relation to low damage design in its Volume 3 report (CERC, 2012):</p> <p data-bbox="347 1429 1193 1456">66. Research should continue into the development of low damage technologies.</p> <p data-bbox="347 1467 1422 1585">67. The Department of Building and Housing should work with researchers, engineering design specialists and industry product providers to ensure evidence-based information is easily available to designers and building consent authorities to enable low damage technologies to proceed more readily through the building consent process as alternative solutions.</p> <p data-bbox="347 1597 1422 1715">68. The Department of Building and Housing should work with researchers, engineering design specialists and industry product providers to progress, over time, the more developed low damage technologies through to citation in the Building Code as acceptable solutions or verification methods. This may involve further development of existing cited standards for materials, devices and methods of analysis.</p> <p data-bbox="347 1727 1422 1798">69. The Department of Building and Housing should foster greater communication and knowledge of the development of these low damage technologies among building owners, designers, building consent authorities, and the public.</p> <p data-bbox="331 1809 1422 1928">MBIE (formerly the Department of Building and Housing referred to above) is supporting the development of this guideline as part of its initiatives to satisfy Recommendations 67 to 69. Seismic isolation is ‘one of the more developed low damage design technologies’ referred to in Recommendation 68, as it has already been widely used in New Zealand.</p> <p data-bbox="331 1939 1422 2058">The Commission also noted in its report that the modern form of base isolation was a mature technology. It is intended that this guideline will eventually be cited as guidance under Section 175 of the Building Act, in accordance with the Commission’s Recommendation 68. Such recognition may not be appropriate until the guideline has been used in practice and the industry is satisfied with it.</p>

Section	Commentary
<p><b>1.1</b></p> <p><i>Continued</i></p>	<p><b>Cost implications</b></p> <p>It is generally considered that isolated structures cost more than conventional non-isolated structures. For example, for common isolation configurations there are additional costs for the isolators and to construct a basement or crawl space beneath a suspended ground floor, and also for detailing items that pass across the isolation plane. There is typically little difference in the structural force demands and cost of the superstructure or foundation. However, there may be cost savings associated with simplified detailing to the structure and reduced displacement demands on building fabric and fit-out. There are examples of buildings that cost less because they were isolated or are of special form that could not have been built if not isolated.</p> <p>There is reasonable evidence that the expected damage for buildings with seismic isolation will be less than for conventional buildings and therefore the costs arising from repairs to earthquake damage and downtime are also likely to be lower.</p> <p>Life cycle cost analysis considering initial construction cost and the expected cost of earthquake damage plus insurance premiums and deductibles would likely show a lower cost of ownership for isolated buildings. It is possible over time that the initial capital cost of seismic isolation will reduce as the industry becomes more familiar with designing and using it. It is also possible that the insurance industry will recognise the benefits of isolated buildings and consider lower premiums.</p> <p><b>Approach taken in this guideline</b></p> <p>The guideline provides a method for designing a range of isolation and energy dissipation systems that are being used in New Zealand.</p> <p>The design methodology recommends parameters for use of NZS 1170.5 and the materials standards for concrete (NZS 3101:2006) and steel structures (NZS 3404:2009), plus appropriate supplementary criteria.</p> <p>For the isolation plane and isolator devices a displacement-based design approach is recommended. For the superstructure and substructure, a force-based design approach, or an approach based on a non-linear numerical integration time history analysis (NITHA).</p> <p>Draft displacement-based design provisions have been prepared for the NZTA Bridge Manual. Although this manual does not specifically address isolated bridges, many of its provisions are applicable.</p> <p>US and Eurocode codes of practice have been reviewed as part of preparing this guideline, principally ASCE 7-16 Chapter 17 and EN 15129:2009.</p> <p><b>Considerations for Type 3 isolated buildings</b></p> <p>Regarding the Type 3 (Complex or Ductile) isolated building type, the rationale to allow ductile demands in isolated superstructures should be very carefully considered. Research has shown that inelastic action in an isolated superstructure can lead to excessive deformation demands and undesirable responses. This is due to the convergence of excitation and predominant response periods as the superstructure experiences damage and softens. The level of ductility permitted, and the level of seismic demand at which yielding is assumed to initiate, should be carefully evaluated. If concluded that such response is permissible, appropriate analysis with nonlinear superstructure modelling should be carried out to confirm acceptable outcomes. This aspect of building response should be explicitly defined as an aspect of design for peer review consideration.</p> <p>A building with multiple towers on a common isolated base should be treated as Type 3.</p>
<p><b>1.2</b></p>	<p><b>Building Code compliance</b></p> <p>For more information about ways to comply with the Building Code including an explanation of acceptable solutions, verification methods and alternative solutions refer to the MBIE website at <a href="http://www.building.govt.nz/building-code-compliance">www.building.govt.nz/building-code-compliance</a></p>
<p><b>1.3</b></p>	<p><b>Peer review</b></p> <p>It may be possible to avoid the requirement for peer review for simpler building types once this guideline has been used and accepted. Parameters affecting the definition of ‘simple’ could include:</p> <ul style="list-style-type: none"> <li>• isolated building Type 1</li> <li>• regularity</li> <li>• the building’s Importance Level</li> <li>• superstructure period and separation of periods of isolated and fixed-base structures.</li> <li>• experience of the designer.</li> </ul>

Section	Commentary
<p><b>1.3</b></p> <p><i>Continued</i></p>	<p>The following items should be considered when developing a peer review briefing. They comprise items particular to a base isolation system and are intended for guidance only.</p> <ul style="list-style-type: none"> <li>• confirmation of seismic weight</li> <li>• estimated superstructure periods and any irregularity</li> <li>• DBD approximation of building performance to establish likely displacements, accelerations and damping</li> <li>• vertical distribution of shear based on nature of systems, isolated period and superstructure period</li> <li>• estimate of torsional actions</li> <li>• appraisal of any potential locations of uplift on the isolation plane</li> <li>• assessment of equilibrium and approximate actions at one 'typical' assemblage of foundation, isolator and structure above and below isolation plane; then approximate member strength checks to correlate</li> <li>• similar assessment for a location with locally significantly higher gravity loads than typical, or a different isolator system</li> <li>• similar assessment for any location with potential uplift, or significant cyclic axial load (e.g. under the end of a frame or the end of a shear wall)</li> <li>• rattle space clearances and inspection of adequacy for movements based on precedent details, and a check to ensure these do not inappropriately hamper the performance of the isolation plane</li> <li>• a check of the approximate shear force in transfer diaphragm above the isolators (and below if applicable)</li> <li>• for NITHA verification an appropriate 3D model with nonlinear elements for isolators, including consideration of potential 'walking' displacements in torsion</li> <li>• a check that appropriate building and isolator characteristics have been transferred to trade specifications (assuming the standards in Chapter 8 for specifications have been used)</li> <li>• detailed review/comments on the Design Features Report.</li> </ul> <p>Further consideration should also be given to areas of particular complexity, any irregularity or potential brittleness, building or site-specific considerations, and the skills and experience of the designer and reviewer – as would be prudent with any peer review.</p> <p>Peer review solely of inputs and outputs by an assessor with little understanding of the limitations of NITHA will rarely provide the degree of overview expected/required.</p> <p>The project-specific NITHA assumptions, design criteria and other associated project documentation should include the following:</p> <ul style="list-style-type: none"> <li>• an outline of the superstructure's structural system, critical elements and capacity design principles applied (if any)</li> <li>• analysis procedure used in the design</li> <li>• geotechnical data including soil characteristics and recommended foundation types and analysis/design parameters</li> <li>• seismic hazard evaluation and selection and scaling of ground motions</li> <li>• analytical modelling summary including all key assumptions, modelling approach and software, definition of mass, identification of force-controlled versus deformation-controlled components, description of which component actions are modelled elastically and inelastically, expected material properties, basis for hysteretic component modelling (including assumptions or test data), component initial stiffness assumptions, joint stiffness assumptions, diaphragm modelling, damping, and soil modelling (if employed)</li> <li>• summaries of laboratory test data and other applicable data used to justify the hysteretic component modelling or the acceptable structural performance</li> <li>• specific acceptance criteria values used for evaluating the nonlinear elements. Associated documentation should also include which component failures are deemed to lead to global collapse, local collapse, or no collapse, as well as the specific criteria used for components of the gravity system</li> <li>• overall building dynamic behaviour including natural frequencies, mode shapes and modal mass participation</li> <li>• key structural response parameter results and comparisons with the acceptance criteria.</li> </ul>

Section	Commentary
1.5	<p><b>Limit states</b></p> <p>The damage control limit state (DCLS) has been defined by Priestley, Calvi and Kowalsky in ‘Displacement-based Seismic Design of Structures’ (2007) whereby a certain amount of damage is acceptable, but the cost of repair should be significantly less than the cost of replacement.</p> <p>Regarding the collapse avoidance limit state (CALC), the Building Code requires that there should be a reasonable margin to prevent collapse in a ‘rare’ earthquake beyond the ULS level of demand. This is often described as the ‘maximum considered earthquake’ (MCE). This level of demand is specified in Chapters 3 and 4.</p> <p>Robustness under greater than design level shaking should be specifically considered. This includes provision of additional isolation system displacement capacity, as well as consideration of how the system as a whole provides robustness to avoid collapse at a shaking intensity corresponding to a larger event. The overall seismic performance of an isolated building is highly dependent on the performance of the isolators and there are potentially adverse implications of bearing over-travel. For these reasons, a specific check needs to be carried out at the CALC.</p> <p><b>Example scenarios:</b></p> <ol style="list-style-type: none"> <li>1. The designer will need to demonstrate that building collapse will be prevented if the rattle space is less than the ‘rare earthquake’ displacement.</li> <li>2. If there is no moat wall to restrict over-travel and the isolation system (i.e. isolators and rattle space) displacement capacity is less than the ‘rare earthquake’ demand, the designer will need to demonstrate how collapse will be prevented.</li> </ol>



**nzsee**  
NEW ZEALAND SOCIETY FOR  
EARTHQUAKE ENGINEERING

## 2. ISOLATED BUILDING SYSTEM AND DESIGN PHILOSOPHY

### CHAPTER CONTENT

### PAGE

2.1 Overview .....	22
2.2 Criteria for each isolated building type .....	22
2.3 Structural performance factor ( $S_p$ ) and force reduction factor ( $k_m$ ) .....	23
2.4 Components of an isolated building and their functions .....	23
2.5 Building component design requirements .....	26
Commentary .....	28

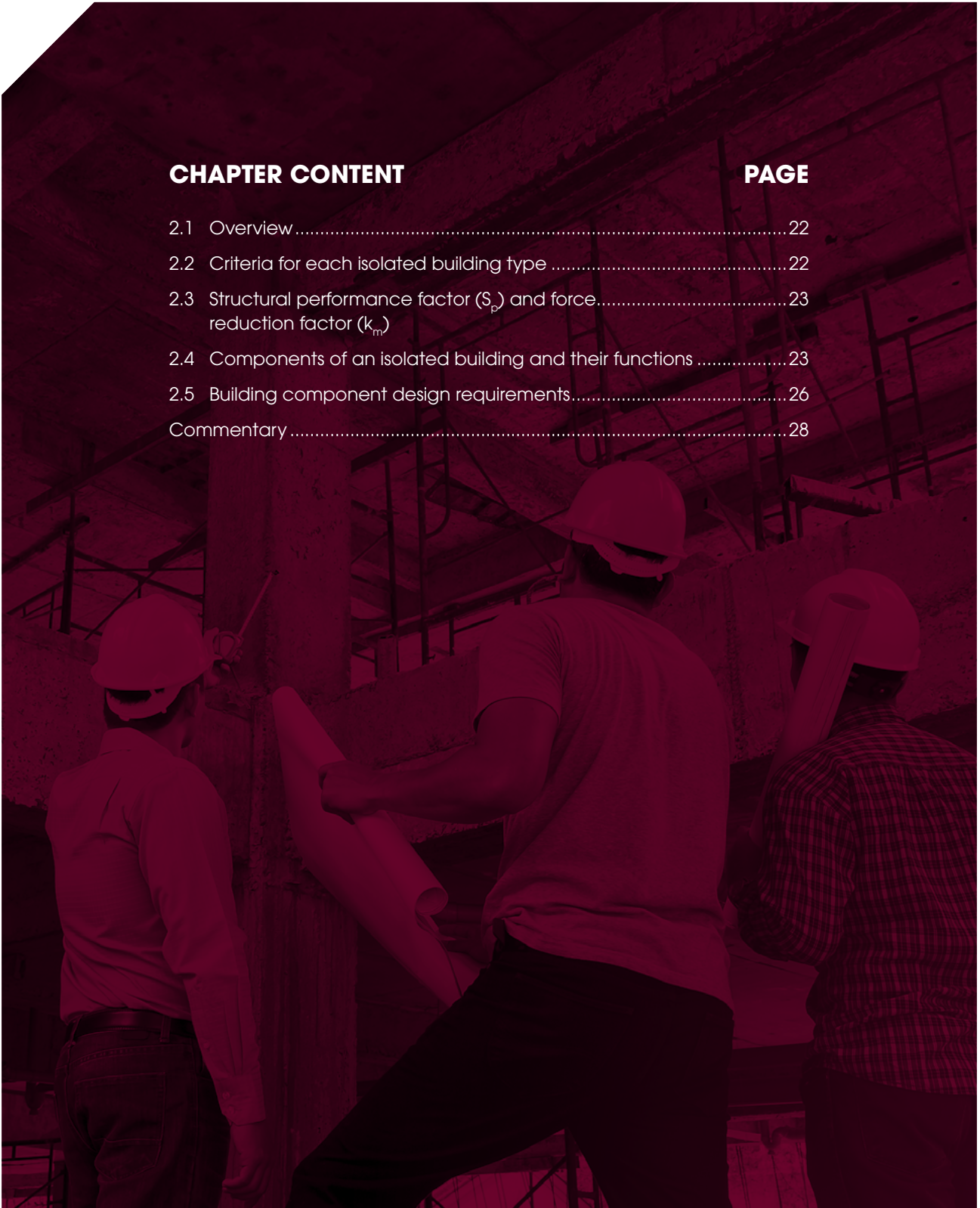

## 2.1 Overview

This chapter sets out the detailed criteria and limitations for the four isolated building types which determine the approach to be used for analysis and design. It also identifies the functions and design philosophy for the five key components of an isolated building.

## 2.2 Criteria for each isolated building type

The criteria to be met for each isolated building type are given in Table 2-1.

**Table 2-1: Criteria for isolated building Types 1 to 4**

Isolated building type	Criteria
<p><b>Type 1: Simple</b></p>	<ul style="list-style-type: none"> <li>• The structure above the isolation plane is less than or equal to four storeys or 20 m in structural height, whichever is less, measured from the isolation plane. These limitations are required to limit higher mode contributions.</li> <li>• The maximum dimension, in plan, of the superstructure does not exceed 50 m.</li> <li>• The effective period of the isolated system at the design displacement is less than or equal to 3.0s.</li> <li>• The fundamental period of the substructure (below the isolation plane) does not exceed 0.20s.</li> <li>• The eccentricity between the superstructure mass and the isolation system centre of strength does not exceed 3% of the superstructure dimension in the same direction the eccentricity is calculated.</li> <li>• Importance Level 2 or 3.</li> <li>• All seismic subsoil classifications (from NZS 1170.5) except Class E.</li> <li>• ULS lateral system force reduction factor <math>k_{\mu} = 1.0</math>.</li> <li>• Single superstructure and/or single isolation plane.</li> <li>• Moderate ductile detailing of superstructure required.</li> <li>• Moat/rattle space minimum size based on CALS maximum displacement.</li> <li>• No net tension or uplift of bearings due to lateral response at ULS.</li> </ul> <p><b>Note:</b> This can be demonstrated by undertaking additional analyses by removing the bearings subject to tension from the model and demonstrating suitable performance still occurs.</p> <ul style="list-style-type: none"> <li>• The isolation system meets all of the following criteria for linear modelling: <ul style="list-style-type: none"> <li>- The effective damping of the isolation system at the maximum displacement is greater than 5% and less than or equal to 30%.</li> <li>- The effective stiffness of the isolation system at the ULS displacement is greater than one third of the effective stiffness at 20% of the design displacement.</li> <li>- The isolation system is capable of producing a restoring force equal to 2.5% of the weight of the superstructure when the displacement is 50% to 100% of the total CALS displacement of the isolation system.</li> </ul> </li> </ul>
<p><b>Type 2: General</b></p>	<ul style="list-style-type: none"> <li>• Does not satisfy Type 1 regularity checks and does not trigger Type 3 irregularity/complexity checks.</li> <li>• Regularity requirements for NZS 1170.5 apply.</li> <li>• The effective period of the isolated system at the design displacement is less than or equal to 3.0s.</li> <li>• The fundamental period of the substructure (below isolation plane) does not exceed 0.20s.</li> <li>• The eccentricity between the superstructure mass and the isolation system centre of strength does not exceed 3% of the superstructure dimension in the same direction the eccentricity is calculated.</li> <li>• Importance Level 2 or 3.</li> <li>• All seismic subsoil classifications except Class E.</li> <li>• Single superstructure and/or single isolation plane.</li> <li>• Moderate ductile detailing of superstructure required.</li> <li>• Moat/rattle space minimum size based on CALS maximum displacement.</li> <li>• No net tension or uplift of bearings due to lateral response at ULS.</li> </ul> <p><b>Note:</b> This can be demonstrated by undertaking additional analyses by removing the bearings subject to tension from the model and demonstrating suitable performance still occurs.</p>

**Table 2-1: Criteria for isolated building Types 1 to 4 (Continued)**

Isolated building type	Criteria
<b>Type 2:</b> <b>General</b> <i>Continued</i>	<ul style="list-style-type: none"> <li>• The isolation system meets all of the following criteria for linear modelling:               <ul style="list-style-type: none"> <li>- The effective damping of the isolation system at the maximum displacement is greater than 5% and less than or equal to 30%.</li> <li>- The effective stiffness of the isolation system at the ULS displacement is greater than one third of the effective stiffness at 20% of the design displacement.</li> <li>- The isolation system is capable of producing a restoring force equal to 2.5% of the weight of the superstructure when the displacement is 50% to 100% of the total CALS displacement of the isolation system.</li> </ul> </li> </ul>
<b>Type 3:</b> <b>Complex or Ductile</b>	<ul style="list-style-type: none"> <li>• Importance Level 2, 3 or 4.</li> <li>• All soil types.</li> <li>• CALS NITHA verification required to confirm isolation maximum displacement.</li> <li>• Lateral system force reduction factor (<math>k_{\mu}</math>) permitted in design. The NITHA verification at CALS is to include P-delta and other potential degrading stiffness effects on the isolation plane properties.</li> <li>• <math>0.1 &lt; \text{stability coefficient (NZS 1170.5)} &lt; 0.3</math>.</li> <li>• At minimum, the primary superstructure elements (including primary 'gravity' elements) and isolator devices to be modelled to account for stiffness contributions and eccentricities where NITHA is being used for verification.</li> <li>• Moat/rattle space minimum size based on CALS maximum displacement unless special study on pounding effects in NITHA is carried out using contact elements.</li> <li>• Systems incorporating viscous dampers.</li> </ul>
<b>Type 4:</b> <b>Brittle</b>	<ul style="list-style-type: none"> <li>• Importance level 2 or 3.</li> <li>• All soil types.</li> <li>• CALS lateral system force reduction factor <math>k_{\mu} = 1.0</math>.</li> <li>• No reliable post-yield capacity; therefore, design is only to an effective CALS.</li> <li>• Moat/rattle space minimum size based on CALS maximum displacement or decreased for existing building retrofit performance, where a capacity of &lt;100%NBS is the object (i.e. where available rattle space is the governing factor limiting retrofit capacity).</li> <li>• No net tension or uplift of bearings/isolators unless NITHA analysis carried out.</li> </ul>

## 2.3 Structural performance factor ( $S_p$ ) and force reduction factor ( $k_{\mu}$ )

In NZS 1170.5, the structural performance factor,  $S_p$ , incorporates a number of effects. For this reason, different values of  $S_p$  are appropriate for different types and components of the isolated building (refer to the commentary for Section 6.2 for more detail).

The structural performance factors from NZS 1170.5 apply to the scaling of input motions for actions on the isolators ( $S_{p,iso}$ ). Force reduction factors ( $k_{\mu}$ ) only apply to the superstructure. Values for  $S_p$  and  $k_{\mu}$  are given in Chapter 6.

## 2.4 Components of an isolated building and their functions

Design should consider the five key components of an isolated building and how each should perform. The methodology for how this performance should be verified is covered in later chapters.

The components, as shown in Figure 2-1, are:

- foundation and substructure
- isolators (bearings and dampers)
- rattle space
- isolator stability structures (elements above and below that isolators are connected to and that provide reaction forces to maintain the stability of the isolators under vertical loads when displaced laterally)
- superstructure.

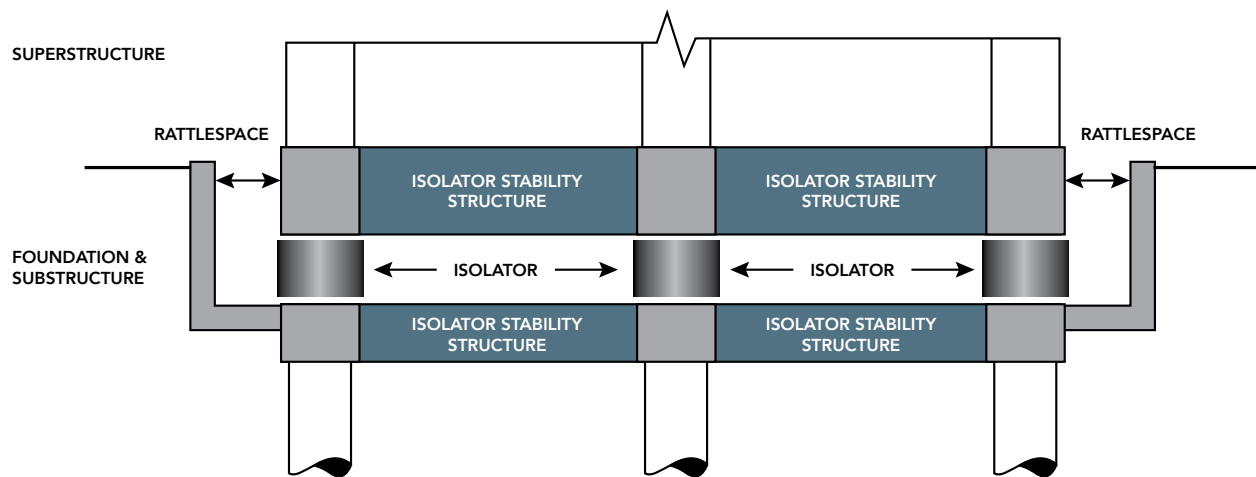

Figure 2-1: Components of a seismically isolated building

### 2.4.1 Foundation and substructure other than isolator stability structures

This component includes all structure below the isolators that is required to support the building and carry the structural forces into the surrounding ground, as would be required for a conventional building.

For lateral forces, it comprises the subsoil above bedrock, foundation and substructure as a whole which transmits the earthquake shaking from bedrock to the underside of the bearings. As the scope of this guideline covers effectively rigid substructures (i.e. with a natural period of less than 0.1s), the earthquake shaking at the underside of isolators is adequately scaled for the seismic subsoil classes in NZS 1170.5.

Substructure should be designed to resist overstrength ULS loads with dependable strengths, which is consistent with NZS 1170.5.

### 2.4.2 Isolators

Isolators should be selected to provide the required overall performance of the building, considering required force-displacement behaviour, restoring force and equivalent damping characteristics.

Bearings should provide dependable performance under all combinations of vertical load and horizontal displacements, including extreme displacements and loads (CALs).

Bearings and dampers should provide damping and force-displacement characteristics within a defined upper and lower bound property variation. This is usually defined as a maximum upper and lower bound for each component and/or an upper and lower bound for all of the components together.

### 2.4.3 Rattle space

Adequate rattle space shall be provided to allow the building superstructure and isolators to displace horizontally as required to meet the demands of the rare earthquake (CALs).

An isolation system robustness factor,  $\alpha$ , has been defined which reduces the size of the rattle space that needs to be provided, based on the consequence for the building of this displacement being exceeded.

Table 2-2 provides the robustness factor for high, medium and low resilience.

As a minimum, the surrounding ground and substructure should be given horizontal clearance from the superstructure for the ULS displacement demand. If contact occurs between the ULS and CALs displacement demand, the effects of this on the superstructure and isolators including the dynamic impact loads should be assessed (refer to Section 2.4.5 commentary).

The isolation system robustness factor (below) associated with contacting the side of the rattle space should be used **in addition** to analysis of the consequences.



**Table 2-2: Isolation system robustness factor**

Resilience available at CALS	Consequences	Correlation with a non-isolated building	Robustness factor, $\alpha$
<p><b>High resilience:</b> Building surrounded by rattle space on all sides</p>	<p>Negligible change in vertical load carrying characteristics. Rattle space damaged by contact and high superstructure demands from impact. Superstructure has ductility capacity including capacity design. Bearings not significantly damaged.</p>	<p>Equated to a well-proportioned ductile capacity designed building which is expected to have some residual resilience even if the CALS actions are exceeded.</p>	<b>1.2</b>
<p><b>Medium resilience:</b> Bearing dependable displacement exceeded Localised collapses of limited height possible but unlikely to pose significant life-safety risk</p>	<p>Bearings damaged by overtravel beginning at extreme corners. Structure vertically displaces less than bearing height due to bearing damage, but vertical load path still exists after settlement.</p>	<p>Risk elevated over a 'normal' structure in that there will be a loss of isolated characteristics in part or all of the isolation plane, with a resulting increase in loads to the superstructure. Superstructure has remaining ductility to withstand vertical and horizontal displacements without collapse.</p>	<b>1.1</b>
<p><b>Low resilience:</b> Superstructure fails due to contacting the rattle space, or falls more than a bearing height at the isolation plane</p>	<p>Impact forces or vertical displacements in bearing(s) where CALS exceeded initiate brittle collapse of significant part or all of superstructure.</p>	<p>Equated to an elastic or nominally ductile designed non-isolated building. The level of load where this likely brittle behaviour can onset is the highest level set to increase CALS actions over ULS actions.</p>	<b>1.0</b>

**2.4.4 Isolator stability structures** 

Isolator stability structures are those required to maintain equilibrium of the isolator when the building is at its maximum displacement. The forces are a combination of forces from any seismic system above, horizontal shears from the bearings, and the P-delta effects of the column loads offset from the substructure due to the isolator displacement. This is described more fully in Chapter 7 Detailing at the isolation plane.

The structural elements providing isolator stability should be able to resist the CALS design actions at the CALS horizontal displacement using *probable* strengths. This is deemed to be satisfied by designing for *dependable* strengths at ULS and *nominal* bearing parameters and using the ratio of CALS/ULS displacement demands to ensure the above is complied with.

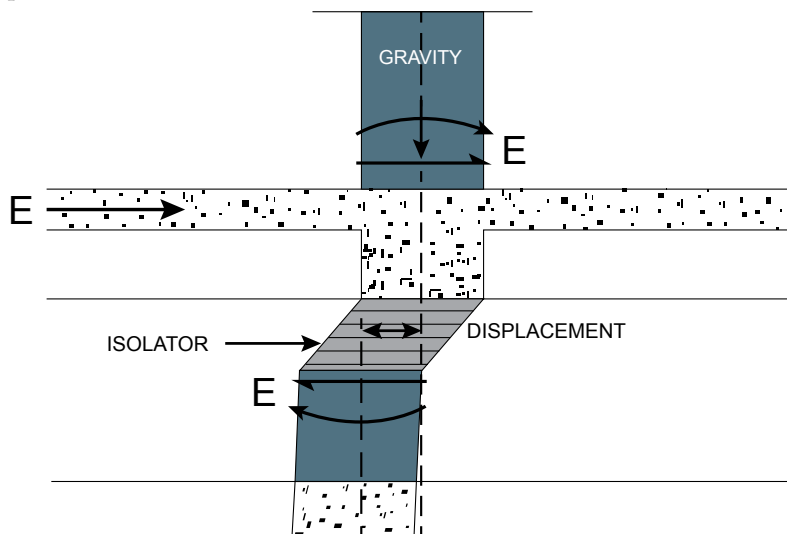

*Figure 2-2: Illustration of typical seismic actions (forces and displacements) to be considered for stability and equilibrium*

### 2.4.5 Superstructure

The structure above the isolation plane will typically remain elastic, retaining probable strength resistance to the base shears from the isolation plane at CALS shaking and nominal bearing parameters.

It is not essential for the superstructure to remain elastic beyond ULS demands. However, traditional concepts of 'ductility' do not apply to the superstructure with regard to reduction of input forces. Careful analysis and design is required to ensure that ratcheting (incrementally increasing plastic lateral displacement) of the superstructure does not occur. Ratcheting is minimised by maintaining a high post-elastic stiffness.

Displacements beyond ULS can occur as a combination of isolation plane and inelastic superstructure displacements. However, the distribution of deformation between the isolation plane and the superstructure is sensitive to the post-elastic stiffness of the isolation plane, the restoring force (or post-elastic stiffness) of the structure, and the interplay between the two, if not designed to remain elastic. This complex interplay needs careful analysis including sensitivity studies of the effects of varying isolator properties on this ratcheting. Analysis requires numerical integration time history methods.

### Superstructure period

The superstructure period in seismically isolated buildings needs specific assessment:

- Superstructure period should be separated from the period of the isolation system. Long period superstructures will give poorer protection to the building, including contents, than stiffer superstructures. They will also potentially give higher drift-related damage.
- Superstructure period must not resonate with the contents (e.g. the natural period of bookshelves in a library). The highest accelerations in the building will be experienced by contents with a similar period to the superstructure.
- Superstructure period should ideally be separated from the ground's natural period. If not well separated, resonance can occur in small earthquakes that are not intense enough to yield the isolation plane. This could cause as much damage/shaking in the superstructure as in a large event. Therefore, this case should be assessed, and the performance aligned with the performance level and client expectations.

## 2.5 Building component design requirements

### 2.5.1 Foundation and substructure

Foundation and substructure shall be designed to resist overstrength ULS loads derived from dependable strengths with analysis carried out in a conventional manner, ensuring soil/structure interaction is properly accounted for. Components providing stability to the isolators are required to resist additional forces as in Section 2.4.4.

### 2.5.2 Isolators

Isolator performance is to be verified through testing.

Two types of testing, prototype and production testing, shall be considered in accordance with AS/NZS 1170.0:2002 Appendix C - Use of Test Data for Design. The testing shall determine yield and stiffness properties, variability and loading rate dependence.

For device types where the method of manufacture, rate of lateral displacement and/or scale affects the properties of the bearing (e.g. the rubber stiffness via curing and the lead plug fitting size/pressure for a lead rubber bearing) prototype bearings should be tested for each bearing size. For the same manufacturer using the same processes, previous prototypes may be considered provided there is sufficient commonality of size and process.

Where device properties are proportionate to the speed of loading, the commonality of previous prototype testing should consider both loading rate (speed) and duration, including heating and wear effects. Refer Table 2-1 for details.

In general, all isolators should be proof tested. A lower portion than 100% may be considered if:

- the device's manufacture process is identical, and consistency is demonstrated through previous proof testing
- the device relies on 'normal' engineering properties (e.g. flexural steel plates) and the mechanics are derivable and can be correlated with previous proof testing.

Refer to Chapters 6 and 8 for the detailed requirements and further information on this topic.

### 2.5.3 Rattle space

The rattle space shall be provided to allow the building isolation plane to displace without affecting the substructure or surrounding structures. The rattle space demand verification depends on the predictability of the structure.

Rattle space dimensions for Types 1 and 2 isolated buildings can be conservatively estimated using static analysis.

Where a modal response spectrum analysis (MRSA) is used, the higher modal effects of the superstructure may increase the rattle space demand and hence the modal analysis will pick up this small additional contribution.

Time history analysis is required to determine rattle space where:

- the isolation plane is not symmetrical but is within irregularity limits
- rattle space clearance is to be less than would be required for a rigid superstructure due to additional superstructure displacement by yielding
- contact with the substructure occurs at less than the CALS displacement demand
- isolation bearings are subject to net tension or uplift at ULS and CALS demands.

### 2.5.4 Isolator stability structures

Design of these structures should be based on 'equilibrium' forces at the required displacement (refer Chapter 7).

### 2.5.5 Superstructure

Superstructure design actions should be determined in accordance with the selected isolated building type and permitted method of analysis.

# COMMENTARY

Section	Commentary
<b>2.4</b>	<b>Components of an isolated building and their functions</b>
<b>2.4.2</b>	<p><b>Isolators</b></p> <p>Table 2-3 below describes typical isolators used in New Zealand at the publication date of this guideline. It includes comments on their behaviour and on some of their advantages and disadvantages.</p> <p>Different types of isolator are often used in combination. Table 2-4 lists common combinations used in New Zealand and comments on the main advantages and disadvantages of these.</p>

**Table 2-3: Overview of common isolator types**

Device type	Description & behaviour	Advantages	Disadvantages
<b>Lead rubber bearing</b>	Elastoplastic device, with the elastic stiffness provided by the steel plate/rubber layered sandwich, and the plastic by the lead plug	Well tried and tested device	Properties dependent on size and fabrication typically requiring prototype and usually production testing. Few facilities able to test large units. Subject to 'scragging' (reduction of stiffness) at large displacements.
<b>Elastomeric rubber bearing (including high damping rubber)</b>	Elastic device, with the elastic stiffness provided by the steel plate/rubber layered sandwich. Some rubber formulations can provide minor damping.	Well tried and tested device	As above. Minimal damping available even with high damping rubber.
<b>Flat slider bearing</b>	Low friction material sliding on polished (usually stainless steel) surface. Hysteretic damping from weight combined with coefficient of friction. (Always used with other elastic restoring force bearings such as lead-rubber or elastomeric bearings).	Cost effective, especially for low mass parts. Large displacements possible.	Depending on the puck surface material, high initial friction and variable high-speed friction. Wear an issue for some low friction materials. Low rotation resistance if not combined with an elastomeric layer in the casing/pot. Potential for stainless degradation.
<b>Single curved slider bearing (pendulum bearing) – articulated puck</b>	Low friction material in rotational housing sliding on polished dish (usually stainless) surface. Hysteretic damping from weight and coefficient of friction. Re-centring from slope of curved surface.	Cost effective. Can provide reasonable re-centring. Large displacements possible.	High initial friction and variable high-speed friction. Wear an issue for some low friction materials. Low rotation resistance depending on pot design. Potential stainless degradation.

Section	Commentary		
<b>Table 2-3: Overview of common isolator types</b> <i>Continued</i>			
Device type	Description & behaviour	Advantages	Disadvantages
<b>Double curved slider bearing (double pendulum) – articulated puck</b>	Low friction material in rotational housing sliding on polished dish (usually stainless) surface. Hysteretic damping from weight and coefficient of friction. Re-centring from slope of curved surface.	Cost effective. Can provide reasonable re-centring. Smaller than a single pendulum. Large displacements possible.	High initial friction and variable high-speed friction. Wear an issue for some low friction materials. Low rotation resistance. Potential stainless degradation.
<b>Triple curved slider bearing (triple pendulum)</b>	Low friction material above and below a rotational housing, each sliding on polished dish (usually stainless) surface. Hysteretic damping from weight and coefficient of friction. Re-centring from slope of curved surface.	Cost effective. Can provide good re-centring. Smaller than a single pendulum, with lower initial release force. Large displacements possible.	High initial friction and variable high-speed friction. Wear is an issue for some low friction materials. Potential stainless degradation.
<b>Cross-linear bearings</b>	Pairs of roller-bearing rails at 90 degrees to each other. Rails may be curved if used in parallel with pendulum bearings.	High hold-up and hold down forces with minimal friction.	No significant damping. Expensive. Durability important.
<b>Viscous damping device (fluid, lead extrusion)</b>	Cylinder extruding a solid/fluid through a constrained area to provide velocity-dependent resistance.	Damping force out of phase with elastic restoring force.	Typically acts in a single axis only for each unit. Can be expensive.
<b>Hysteretic damping device (steel flexural plate, torsion bar)</b>	Elastoplastic force deflection device.	Can be inexpensive and tailored easily to geometry.	Large displacements can be difficult to achieve.
<b>Rocking column/sleeved pile</b>	Displacement and restoring provided by 'long' columns in pile sleeves. Rocking columns can provide similar performance.	Can be provided in conjunction with pile solution.	Can be complex and expensive. Additional damping required.

Section	Commentary
---------	------------

**Table 2-4: Common bearing combinations used in New Zealand**

Combination	Advantages	Disadvantages
<b>Lead rubber + flat sliders</b>	Cost effective and practical. Damping can be tuned with proportion of lead and slid weight.	The more weight on sliders the more variable the isolation performance (as sliders have more variability, relying on friction compared with lead yield).
<b>Elastomeric + flat sliders</b>	Cost effective and practical	The more weight on sliders the more variable the isolation performance (as sliders have more variability, relying on friction).
<b>Elastomeric + hysteretic damping</b>	Cost effective solution, more common for bridges.	Difficult to provide for large displacements.
<b>Sleeved pile + viscous dampers</b>	Good control of near fault effects, large displacements possible.	Cost. Particular solution only really affordable if deep piling required.
<b>Pendulum devices</b>	Cost effective. Low superstructure accelerations in the case of triple pendulums. Very high displacements possible.	Likely to be unsuitable for sites where differential foundation settlements are possible. Sensitive to torsion/moving shear centre in tall structures, and higher mode effects coupled with vertical accelerations.

**2.4.3**

**Rattle space**

The moat or rattle space available to the isolated structure is a fundamental aspect of providing an isolation system that satisfies the intent of a low damage design using isolation. Generally, a key driver for implementing base isolation in a project is to provide a low damage and reliable structural solution to meet seismic demands.

The rattle space allows the horizontal movement of the building. This is normally critical, under CALS, at its extreme corners due to design or accidental eccentricity. It is usual to provide this clear space unless there is a particular project constraint, or a special design outcome is sought.

Typically, surrounding ground and substructure is given horizontal clearance from the superstructure for a minimum of the rattle space. For this arrangement, there are three types of consequence of the CALS hazard horizontal displacements being exceeded. To make the relative life safety risk in the superstructure equivalent for these three types of behaviour, the level of earthquake shaking for CALS (definition of target rattle space) is adjusted by the isolation system robustness factor given in Table 2-2.

Impact of the isolated structure against a moat wall or rigid retainer for demands less than CALS can impose very large and unpredictable shock loadings on the superstructure. While nonlinear time history analysis does allow contact elements to be incorporated to capture this pounding behaviour, numerous investigations by researchers have demonstrated that the level of uncertainty around the accelerations and the characterisation of various model parameters makes reliable modelling difficult.

ASCE 7-10 identified the total maximum displacement as the MCE isolation displacement including actual/additional torsion effects and states that this value is used for "...design of structure separations...". It is noted that the displacement restraint system is defined below this as: "A collection of structural elements that limits lateral displacement of seismically isolated structures due to the maximum considered earthquake". The interpretation of these items is that the structural separations apply to isolation plane-to-moat wall distances, while the displacement restraint system would be an intentional system of devices intended to slow the building down beyond ULS (e.g. viscous dampers that are initiated at displacements beyond ULS).

In ASCE 7-16 the allowances for displacement restraint indicate that nonlinear dynamic analysis is required to be used as a means of performance verification. Similarly, the capacity of the substructure is not exceeded at MCE demands, and stability and ductility are ensured for the superstructure. The displacement restraint can be applied at a minimum  $0.75D_{TM}$  unless satisfactory performance can be demonstrated for a greater reduction.

Section	Commentary
<p><b>2.4.3</b> <i>Continued</i></p>	<p>The acceleration and drift amplification that has been observed in these studies of isolated structures impacting on moat walls (and in the field, from the FCC building in Northridge, California) is generally severe, particularly for the storey immediately above the isolation plane. Accelerations recorded are in the range of 6-7g, which produce column/wall shears well above that considered in conventional capacity design procedures. The transmission of this response to the upper floors is also substantial. The implications from the research results is that collapse probabilities increase beyond what might be considered acceptable if trying to match the performance back to a design standard. Similarly, the design accelerations for parts and components become difficult to define and the implications wide-ranging when considering that elements such as precast panels and their fixings must stay connected to the base building at these spiked MCE demands.</p> <p>It is recommended that for new building design the isolation plane and moat rattle space are sized to the CALS maximum isolation displacement. Specific intent to move away from this should be treated with caution by the designer. It is likely that this would form a significant item of peer review and substantial analysis data would need to be presented.</p> <p>If an isolation scheme is being introduced to an existing structure, then the nature of the structure and neighbouring sites may well limit the rattle space available. In such circumstances, if pounding is considered unavoidable then the designer must communicate the decision and its potential effects to the client. This will inherently limit the percentage of current code demand that the isolated building can achieve, in much the same way as current assessment procedures would determine. It should be noted that existing structures will typically not have sufficient detailing to accommodate the impact accelerations and that the limited rattle space distance is likely to control the CALS performance for the building.</p>
<p><b>2.4.4</b></p>	<p><b>Isolator stability structures</b></p> <p>If all frame and bearing properties and geometries are explicitly modelled these forces can be derived from the analysis. However, not all analysis programs capture the P-delta effects locally. It is recommended that approximate checks using the 'equilibrium' forces are carried out as a check on the analysis output.</p>
<p><b>2.4.5</b></p>	<p><b>Superstructure</b></p> <p>The design procedures in Chapter 6 include conservatism in the 'base shear' for the superstructure depending on the complexity of the analysis.</p> <p>For Type 1 (Simple) structures the provision of <i>dependable</i> strengths with no '<math>S_p</math>' reduction for non-structural participation in the superstructure at ULS should ensure the expected performance above is achieved for the range of isolator properties permitted for these structures.</p> <p>The procedure is similar for Type 2 (General) structures. However, the provision of <i>ideal</i> strengths at ULS reflects the inferred greater understanding of superstructure forces through the more complex analysis.</p> <p>For Type 3 (Complex or Ductile) structures, the need for time history verification stems from the fact that:</p> <ol style="list-style-type: none"> <li>1. there is complexity of the building in regularity, uplift and possible multiple structures on a podium</li> <li>2. the rattle space is exceeded before CALS horizontal displacements are reached</li> <li>3. a nonlinear (ductile) mechanism is formed in the superstructure between ULS and CALS.</li> </ol> <p>In the case of point 3, the actual ductility demand on the superstructure can only be assessed by including for nonlinearity in the analysis model above the isolation plane. This may be done in a simplified manner (single or lumped superstructure mass, stiffness and nonlinearity, over a nonlinear isolation plane) to estimate the ratchetting only, or by modelling all members but with those expected to yield being nonlinear. Refer to Chapter 7 for more detail. The actual ductility demand will come as a product of the analysis from peak superstructure displacement. The residual superstructure displacement must also be considered in the light of the residual capacity of the overall building to withstand future aftershocks.</p> <p>For modelling of impact in the rattle space the time history verification is very complex and needs to consider the dynamic effects on the superstructure from the impact, which may produce larger base shears than the elastic base shears at CALS. The superstructure response to impact is very sensitive to the stiffness of the gap elements used in the analysis. Unless specific buffer devices are included in the design and construction the gaps should be considered essentially rigid to capture the acceleration and shear effects conservatively. However, they should not be considered overly rigid or this will create mathematical</p>

Section	Commentary
<p><b>2.4.5</b> <i>Continued</i></p>	<p>loss of accuracy in the stiffness matrices. As these effects are very short period impulses, it is essential that the damping formulation does not overdamp these from the analysis because this would not be conservative.</p> <p>Where the performance requires ductility in the superstructure or impact of the rattle space, it will require detailed peer review as these are extremely complex and sensitive to input and analysis parameters.</p> <p>Type 4 (Brittle) structures are treated as per Type 1 or 2 depending on superstructure complexity, but the hazard is modified because:</p> <ol style="list-style-type: none"> <li>1. less than 100% of the hazard is targeted as a retrofit (i.e. &lt;100%NBS). This can be a product of a limited rattle space governing the degree of isolation possible, for example due to adjacent structures.</li> <li>2. brittle collapse onsets immediately beyond CALS – the robustness factor is not permitted to reduce the hazard because of this consequence.</li> </ol> <p><b>Superstructure period</b></p> <p>Rules of thumb include:</p> <ul style="list-style-type: none"> <li>• The isolated period should be more than 3x the fixed-base superstructure period.</li> <li>• The superstructure period should be a minimum of 1 second less than the isolated period.</li> </ul> <p>Additionally, for very stiff superstructures or isolators that are flexible pre-yield, if the pre-yield isolator period/superstructure period is less than 0.5, checks should be performed for additional higher-mode effects in the superstructure (e.g. high floor spectra or ‘bulged’ shear distributions).</p>





**nzsee**  
NEW ZEALAND SOCIETY FOR  
EARTHQUAKE ENGINEERING

### 3. BUILDING PERFORMANCE

<b>CHAPTER CONTENT</b>	<b>PAGE</b>
3.1 Overview .....	34
3.2 Low damage design .....	34
3.3 Performance objectives .....	34
3.4 Performance criteria .....	36
3.5 External factors .....	37
3.6 Instrumentation and monitoring .....	37
Commentary .....	38



MINISTRY OF BUSINESS,  
INNOVATION & EMPLOYMENT  
HIKINA WHAKATUTUKI



**NZCS** | New Zealand  
Concrete Society



### 3.1 Overview

This chapter guides the owner's selection of performance objectives and criteria in addition to Building Code requirements, especially those relating to the reduction of damage and downtime.

A focus on building performance enables both designer and owner to identify, understand and choose a range of performance objectives rather than being limited to a building that 'meets code'.

Building performance can be considered at several 'performance points'. These correspond to the extent of cost or time to repair or reoccupy the building which the owner will accept for different levels of earthquake shaking. Performance points (limit states) defined by the Building Code include both serviceability limit states, SLS1 and SLS2, and the Ultimate Limit State (ULS). Additional limit states to control damage (DCLS) and avoid collapse (CALC), as described in Section 1.5, are also considered in this guideline.

### 3.2 Low damage design

This guideline is intended to be consistent with the low damage design (LDD) framework established by the LDD Guideline currently being developed by SESOC, with support from MBIE. Designers of isolated buildings should also refer to this guideline.

It should be noted that the performance objectives and assessment criteria in this guideline may not be fully aligned with the LDD Code of Practice until both documents are finalised.

### 3.3 Performance objectives

Table 3-1 provides the performance objectives and criteria for isolated buildings.

Performance objectives under seismic demand can be categorised into three dimensions (refer to Quakestar, USRC-EQ Performance Rating System and REDi for more information). These are:

- safety - i.e. the extent of death or injury
- damage - i.e. the cost of damage, both structural and non-structural, based on the cost of repair
- downtime - i.e. the time to regain building function.

This guideline defines two building performance levels for seismically isolated buildings, as also shown in Table 3-1.

- Recommended (5 Star)  
To be used in most situations and where there are no site constraints, such as limited boundary separation.
- Minimum (4 Star)  
To be used where rattle space is limited, or other factors constrain the design; e.g. retrofit with limited boundary clearance, or where the client accepts a slightly lower performance standard.

There may be retrofit situations where space is so limited that the performance level does not meet this 'minimum'. Isolation may still offer advantages over a fixed base solution for such a structure.

Note that a conventional (fixed base) 'Code minimum' building would typically correspond to a 3 Star rating for safety.

Table 3-1: Limit states, performance objectives and criteria for isolated buildings

Earthquake severity			Performance dimension	Performance description		Building Code requirement
Description	Return period	Limit state		Minimum	Recommended	
<b>MINOR</b>	25 years	SLS 1	Safety	No expected entrapment of occupants	No expected entrapment of occupants	No specific code requirement
			Damage	No expected damage	No expected damage	No damage requiring repair
			Downtime	No expected downtime	No expected downtime	No specific code requirement
<b>MODERATE</b>	250 years	DCIS (Not in NZ Codes)	Safety	No expected entrapment of occupants	For 5 Star use 500 year return period	No code requirement
			Damage	Residual bearing displacement possible. No expected damage to rattle space.	For 5 Star use 500 year return period	No code requirement
			Downtime	No expected downtime	For 5 Star use 500 year return period	No code requirement
	500 years		Safety	For 4 Star use 250 year return period	No expected entrapment of occupants	No code requirement
			Damage	For 4 Star use 250 year return period	Residual bearing displacement possible. No expected damage to rattle space	No code requirement
			Downtime	For 4 Star use 250 year return period	No expected downtime	No code requirement
<b>LARGE</b>	500 years (for IL2) 1000 years (for IL3) 2500 years (for IL4)	ULS	Safety	No expected entrapment of occupants	No expected entrapment of occupants	No expected deaths
			Damage	Repair expected to be less than 10% building value.	Residual bearing displacement possible. Residual superstructure drift possible. Repair expected to be less than 5% of building value	No code requirement
			Downtime	Function expected to be regained in days	Function expected to be regained in hours	No code requirement

**Table 3-1: Limit states, performance objectives and criteria for isolated buildings (Continued)**

Earthquake severity			Performance dimension	Performance description		Building Code requirement
Description	Return period	Limit state		Minimum	Recommended	
				<b>4 Star</b> (***)	<b>5 Star</b> (****)	
<b>LARGE</b>	Code required for IL4 only	SLS2	Safety	No expected entrapment of occupants	No expected entrapment of occupants	No specific code requirement
			Damage	Services functional, minor repairable damage expected	Services functional, minor repairable damage expected	No specific code requirement
			Downtime	No expected downtime	No expected downtime	Operational continuously
<b>RARE</b>	2,500 years (for IL2)	CALS	Safety	Minimal injuries	No expected entrapment of occupants	No collapse
			Damage	Damage at rattle space likely. Repair > 10% building value	Repair expected to be < 10% building value	N/A
			Downtime	Regain function within weeks/months	Function expected to be regained in days	N/A

### 3.4 Performance criteria

In order to specify or confirm a performance level, the appropriate performance criteria need to be assessed. Table 3-1 above sets out the performance criteria for isolated buildings.

Discussion, agreement and documentation of the performance standards in a Design Features Report is required. This report would also be expected to include a table of performance requirements for the DCLS. Table 3-2 provides an example of such a table, summarising the non-structural performance criteria for isolated buildings for the DCLS. Note that significant collaboration between several building disciplines will be needed.

**Table 3-2: Non-structural performance criteria for the damage control limit state (DCLS)**

Item	Description
Performance level	Damage control limit state
Return period	250 years or 500 years
Secondary structure	Secondary structure retains its strength and stiffness. Minor non-structural partition damage. Façade water tightness largely maintained. All building services remain operational with only minor repairs required. All fire and emergency systems operational.
Rattle space	Cover plates: residual movement likely (refer to Section 7.7) and minor repairs likely depending on detailing.
Ceilings	Ceiling systems generally remain intact. Minor damage related to movement. No dislodgement.
Cladding	Cladding undamaged, movement joints may have minor damage.
Lifts	Lifts operational but may have minor damage.
Stairs	Stairs remain fully functional. Undamaged.
HVAC	Units are secure and operational.
Services ducts	Minor movement at joints but remain serviceable.
Services pipework	Serviceable. No leaks resulting in damage.
Fire sprinkler system	Sprinkler system operational. No leaks resulting in damage.
Fire alarm system	Alarm system operational.
Fireproof cladding	Fire proofing intact. No damage reducing effectiveness.
Emergency lighting	Operational.
Electrical systems	Units are secure and operational. Minor damage to some parts of the lighting.
Shelving	Unrestrained shelving remains upright; books may fall off.
Contents	Items such as ornaments or appliances may fall over or fall from raised surfaces. Furniture may slide or overturn.

### 3.5 External factors

Factors which could affect building occupancy or operation beyond the specific building performance, such as wider site effects on access or services, need to be considered when assessing overall performance.

### 3.6 Instrumentation and monitoring

Using instruments is a way to monitor performance and establish confidence in a structure following a significant earthquake. Therefore, engineers may suggest currently available options to clients. As a minimum, the installation of two scratch plate devices should be considered.

# COMMENTARY

Section	Commentary
<p><b>3.1</b></p>	<p><b>Overview</b></p> <p>A building can be designed for a desired level of performance under a certain load scenario. This is effectively performance-based design, which is not new. An element of this is embodied in the New Zealand Building Code which prescribes certain performance requirements at three limit states: serviceability limit state (SLS: at SLS1 and SLS2), ultimate limit state (ULS) and collapse avoidance limit state (CALC).</p> <p>A broader framework of performance-based design enables performance to be targeted at other scenarios, including performance descriptors in between these limit states. As noted above, this guideline includes an assessment of performance at a damage control limit state. It is noted that ASCE 41-13: Seismic Evaluation and Retrofit of Existing Buildings includes the ‘immediate occupancy’ performance descriptor which is similar to the damage control limit state (DCLS).</p> <p>A building’s performance level can be targeted to its use or function. For example, a call centre may want rapid reoccupancy or continual operation following a 1 in 500-year event. The DCLS could be used to target the building performance to enable this. This may be by limiting superstructure drift, residual bearing displacement to maintain water tightness and/or floor accelerations to ensure the building can be operational within a specified time. This would mean no injury and minor non-structural damage that can be cleaned up but does not compromise fire egress. Alternatively, there may be a piece of equipment which will be damaged by a certain floor acceleration. In this case, a structural system can be selected to reduce the floor accelerations during the chosen event (say 1 in 250 years) to control damage.</p>
<p><b>3.2</b></p>	<p><b>Low damage design</b></p> <p>Earthquake damage results from drift and floor accelerations. Generally, structural and non-structural elements such as cladding and glazing are damaged by inter-storey drifts. Plant and equipment usually suffer more damage resulting from local accelerations at each floor, which are a function of a building’s response to earthquake shaking. Seismic isolation is able to significantly reduce both inter-storey drifts and floor accelerations.</p> <p>Design for damage control would likely consider performance objectives and criterion for the following criteria:</p> <ul style="list-style-type: none"> <li>• structural damage mitigation effectiveness</li> <li>• repairability</li> <li>• drift and residual drift</li> <li>• floor acceleration</li> <li>• self-centring ability</li> <li>• durability and maintenance</li> <li>• DCLS, UCLS and CALS performance</li> <li>• development and testing of a LDD system</li> <li>• non-structural damage</li> <li>• contents damage or disruption</li> <li>• cost</li> </ul> <p>A brief discussion of how LDD objectives and criteria can be applied to an isolated building follows.</p> <p><b>Structural damage mitigation effectiveness</b></p> <p>This includes all damage to the superstructure, isolation system or rattle space which will occur in the limit state under consideration. Examples of variables affecting structural damage include the amount of ductility permitted in the superstructure and the availability of rattle space.</p> <p><b>Repairability</b></p> <p>This relates to how easily structural damage, when it occurs, can be repaired. The philosophy does not preclude structural damage, but this will need to be identified and understood. Damage should generally be limited to areas where damage is acceptable and can be repaired. Consideration of a hierarchy of damage is needed to ensure this occurs. For example, at CALS there may be a risk that bearings would need to be replaced – how would this be done?</p>

Section	Commentary
<p><b>3.2</b> <i>Continued</i></p>	<p>The rattle space is a critical part of the isolation system. It may also serve to limit travel of the isolators and to ‘stop’ the building at a level beyond ULS. Further consideration of this is provided in Chapter 2. Depending on the level of performance, visual nature and cost of the detailing, the extent this can be ‘low damage’ may vary at a project level and in different areas/access routes in the building. Through a range of events, damage associated with the rattle space (e.g. moat covers) and their reparability may be significant.</p> <p><b>Residual drift</b></p> <p>For an isolated building, it is necessary to consider residual drift in the superstructure and residual displacement at the isolation plane. Residual drift at the isolation plane is likely to be especially important for both SLS, SLS2 (for IL4 buildings); i.e. weathertightness may be a code requirement. Note that residual drift may occur at lower levels of demand when shaking is only slightly greater than isolator yield. Therefore, this is a DCLS requirement.</p> <p>Recent full-scale shake table tests at E-Defense provide useful data on residual drifts (refer Ryan and Dao, 2016). ASCE 7-16 provides a means of calculating the residual drift in the isolation system (Clause 17.2.6 “Elements of Structures and Non-structural Components”). The three tables in the related commentary show the order of magnitude of residual drifts in longer period, higher yield level isolation systems. FEMA P-58 also provides criteria for the possibility of residual drifts in the structural frame as a function of the allowable inter-storey drifts.</p> <p><b>Self-centring ability</b></p> <p>Lead rubber and Friction Pendulum™ bearings have inherent self-centring through the rubber in a lead rubber bearing and the slope of the bearing surface in a pendulum bearing. It should be noted that the building may not precisely self-centre due to the system dynamics, which depend on the specific earthquake motion and nonlinear behaviour of the bearings.</p> <p><b>Non-structural components</b></p> <p>Large inter-storey drifts associated with flexible structural systems can result in significant damage to non-structural components such as partitions and cladding.</p> <p>Due to the reduction in superstructure demand, inter-storey drifts are reduced by the isolation system which results in less damage. Note that depending on the choice of the lateral system for the superstructure, careful detailing of partitions may still be required to control damage.</p> <p><b>Contents damage</b></p> <p>Stiff buildings typically have higher floor accelerations which leads to higher levels of plant and contents damage. An isolation system reduces floor accelerations which results in less damage.</p>
<p><b>3.3</b></p>	<p><b>Performance objectives</b></p> <p>Seismic isolation is generally considered to be the highest performing low damage technology currently in use. This technology comes with the market expectation that it will always provide better performance than other low damage systems or a conventional building. For this reason, a minimum level of performance for isolated buildings has been established as ‘4 Star’. This is above the current minimum Building Code performance requirement for a conventional building, which aligns with 2 Stars, according to the USRC – EQ Performance Rating System.</p> <p>There are reasons to use isolation in situations where it may not be realistic to provide the best possible performance, due to specific constraints or client requirements. However, isolation may still offer significant performance benefits above other systems.</p>
<p><b>3.4</b></p>	<p><b>Performance criteria</b></p> <p>Table 3-2 contains example criteria for performance of non-structural elements. It should be noted that a level of care and responsibility is required by the full design team in order to develop and agree these criteria.</p> <p>Performance objectives and criteria need to be raised, discussed and become part of the building brief as early as possible in the project.</p>

Section	Commentary
<p><b>3.5</b></p>	<p><b>External factors</b></p> <p>It is important to consider factors which could affect building occupancy or operation outside of the building performance itself. For example, will water supply or sewers be functioning? Do neighbouring buildings or site hazards such as ground instability pose a significant risk, or are they likely to prevent building access or egress? Other hazards such as tsunami or inundation should also be considered, especially for higher levels of performance in more extreme events.</p>
<p><b>3.6</b></p>	<p><b>Instrumentation and monitoring</b></p> <p>Following the Canterbury earthquake sequence of 2010-11 and the 2016 Kaikoura earthquake, public awareness of building safety in New Zealand has come to the fore. Using instruments to monitor a building is a method of establishing confidence in a structure following a significant earthquake that is gaining acceptance as the cost of the technology improves.</p> <p>Structural monitoring uses instrumentation installed on the building to measure actions that a structure undergoes during a seismic event. It then uses this information to characterise the performance of the building. While this information can be used to consider the life of the building and how it responds to various influences during its life, the main purpose of such a system in New Zealand is to assess the effect of a seismic event on the structure. Installing instrumentation can provide an accurate picture of a building performance immediately following a seismic event.</p> <p>Typically, this is done with accelerometers to determine acceleration, velocity and displacement. It can include additional instrumentation.</p> <p>The benefits of structural monitoring are that it:</p> <ul style="list-style-type: none"> <li>• provides real-time accurate information on what shaking the building experienced in a seismic event, and how the building and its contents have responded</li> <li>• gives more certainty regarding occupancy following a significant earthquake</li> <li>• can help reduce downtime following a significant earthquake</li> <li>• identifies any degradation or loss of stiffness due to a seismic event and reduces the risk of damage being missed.</li> </ul> <p>It is recommended that at least two scratch plate devices are included at the isolation plane. This enables cost effective capture of some basic displacement data.</p>





**nzsee**  
NEW ZEALAND SOCIETY FOR  
EARTHQUAKE ENGINEERING

## 4. SEISMIC HAZARD SPECTRA AND GROUND MOTIONS

### CHAPTER CONTENT

### PAGE

4.1 Overview .....	42
4.2 Acceleration and displacement seismic demands.....	42
4.3 Site-specific hazard studies .....	46
4.4 Selection and scaling of ground motion records.....	47
4.5 Conditional mean and conditional spectra methods .....	48
Commentary .....	49



MINISTRY OF BUSINESS,  
INNOVATION & EMPLOYMENT  
HIKINA WHAKATUTUKI



**NZCS** | New Zealand  
Concrete Society



**Quake Centre**  
Delivering Industry Solutions

## 4.1 Overview

This chapter provides requirements and guidance for elastic site hazard spectra for isolated structures and for selecting and applying earthquake ground motion records for response history analysis to supplement the requirements of the New Zealand seismic design standard NZS 1170.5.

The specific modifications and additions to this standard are summarised below and then explained in more detail.

- Expressions are provided for acceleration spectral shape factors extended to periods of 10s, beyond the 4.5s maximum period of NZS 1170.5. For most parts of the country the period  $T_L$ , at which the spectral shapes change from constant spectral-velocity behaviour to constant spectral-displacement behaviour, is increased from the NZS 1170.5 value of 3s, modifying the NZS 1170.5 spectral shape factors for long periods.
- Provision for modification for damping different from 5% of critical viscous damping is added to the elastic site hazard spectra expression.
- The displacement shape factors are also provided, in equation, tabular and plotted form. The hazard is also specified in acceleration-displacement format for use in capacity-demand plots.
- Expressions are provided for the hazard levels to be considered for demonstration of collapse-avoidance in motions stronger than the ultimate limit state.
- Reference is given to new expressions for vertical acceleration spectra in NZS 1170.5:2004 Amendment No. 1.
- Guidance is provided on modifications to the NZS 1170.5 procedures for numerical integration time history analysis (NITHA), bearing in mind that the period range of relevance is often broader for seismically-isolated structures than for conventional ones. The guidance extends beyond the NZS 1170.5 approach, in which accelerograms are scaled to provide a least-squares match over a specified period range of the uniform-hazard based NZS 1170 spectra, to include discussion of conditional mean spectra and more general conditional ground motion measures.

## 4.2 Acceleration and displacement seismic demands

### 4.2.1 Elastic site acceleration spectra for horizontal loading

The elastic site hazard spectra for horizontal loading,  $C(T)$ , for a given return period and site class shall be given by

$$C(T) = C_b(T) Z R N(T,D) B_\xi(\xi_{eff}) \quad (\text{Eq. 4-1})$$

where the spectral shape factor  $C_h(T)$ , hazard factor  $Z$ , return period factor  $R$  and near-fault factor  $N(T,D)$  are as defined in NZS 1170.5 Clause 3.1 except that  $C_h(T)$  is modified as given in Equations 4-2 and 4-3, and  $D$  corresponds to the shortest distance from the site to the closest of the major faults listed in NZS 1170.5 Table 3.6. The damping reduction factor  $B_\xi$  for the effective damping  $\xi_{eff}$  (expressed in terms of fraction of critical viscous damping) is given in Equation 5.5, along with appropriate values of the effective damping and how to determine them.

For periods from 3s up to a long-period corner  $T_L$ , the spectral shape factor  $C_h(T)$  for a period of  $T$  s shall be determined from

$$C_b(T) = C_b(3s) * (3/T) \quad 3s \leq T \leq T_L \quad (\text{Eq. 4-2})$$

$$= C_b(T_L) * (T_L/T)^2 \quad T > T_L \quad (\text{Eq. 4-3})$$

$C_b(3s)$  is as given by Clause 3.1.2 of NZS 1170.5 for the corresponding site class or site period  $T_{site}$ , while  $C_b(T_L)$  is as determined from Equation 4-2 for the period  $T_L$  specified for the location in Table 4-1.

**Table 4-1: Corner periods  $T_L$  throughout New Zealand for assigned moment magnitude  $M_w$** 

Regional/district council	Assigned $M_w$ <sup>1</sup>	Corner-period $T_L$ (s)
Northland/Auckland	6.5	3
Waikato, Taranaki, Western BOP, Tauranga, Rotorua	6.9	5
Elsewhere in New Zealand	7.5	≥10

**Key:**  
1. Magnitudes based on those recommended for consideration in determining collapse-avoidance motions in Figure 6-3 of the NZTA Bridge Manual (2016), with consolidation of some regions.

#### 4.2.2 Elastic site displacement spectra for horizontal loading

The elastic site displacement spectra for horizontal loading  $\Delta(T)$  for a given return period and site class shall be determined from

$$\Delta(T) = \Delta_h(T) Z R N(T,D) B_\xi \quad (\text{mm}) \quad (\text{Eq. 4-4})$$

where  $B_\xi$  is the spectral scaling factor (damping reduction factor) to account for the level of effective damping given by Equation 5-5, and where the displacement spectral shape factors  $\Delta_h(T)$  are as defined by the following equation or listed in Table 4-2, and plotted in Figure 4-1:

$$\Delta_h(T) = g C_h(T) (T/2\pi)^2 \quad (\text{mm}) \quad (\text{Eq. 4-5})$$

where  $g$  is the acceleration of gravity in units of  $\text{mm/s}^2$  and  $\Delta_h(T)$  and  $\Delta(T)$  are in units of mm.

For site periods  $T_{\text{site}}$  between 0.6s and 1.5s, site-period based spectral shape factors  $\Delta_h(T, T_{\text{site}})$  may be determined by interpolating  $C_h(T)$  between site subsoil Classes C and D, as given in NZS 1170.5 Amendment No. 1 Clause 3.1.2.

**Table 4-2: Displacement spectral shape factors**

Period T(s)	Displacement spectral shape factors $\Delta_h(T)$ (mm)			
	Site subsoil class			
	A, B Strong rock, rock	C Shallow soil	D Deep or soft soil	E Very soft soil
0.0	0	0	0	0
0.05	1	1	1	1
0.075	3	4	4	4
0.1	6	7	8	8
0.2	23	29	30	30
0.3	53	66	67	67
0.4	75	94	119	119
0.5	99	124	186	186
0.56	114	143	232	232
0.6	125	156	254	268
0.7	151	189	308	365
0.8	179	224	364	477
0.9	207	259	421	604
1.0	236	295	481	745
1.5	391	490	797	1240
2.0	522	656	1060	1650
2.5	652	820	1330	2060
3.0	783	984	1590	2470
3.5	913 <sup>1</sup>	1150 <sup>2</sup>	1860 <sup>3</sup>	2890 <sup>4</sup>
4.0	1040 <sup>1</sup>	1310 <sup>2</sup>	2130 <sup>3</sup>	3300 <sup>4</sup>
4.5	1170 <sup>1</sup>	1480 <sup>2</sup>	2390 <sup>3</sup>	3710 <sup>4</sup>
5.0	1300 <sup>1</sup>	1640 <sup>2</sup>	2660 <sup>3</sup>	4120 <sup>4</sup>
6.0	1570 <sup>1</sup>	1970 <sup>2</sup>	3190 <sup>3</sup>	4950 <sup>4</sup>
7.0	1830 <sup>1</sup>	2300 <sup>2</sup>	3720 <sup>3</sup>	5770 <sup>4</sup>
8.0	2090 <sup>1</sup>	2620 <sup>2</sup>	4250	6600 <sup>4</sup>
9.0	2350 <sup>1</sup>	2950 <sup>2</sup>	4780 <sup>3</sup>	7420 <sup>4</sup>
10.0	2610 <sup>1</sup>	3280 <sup>2</sup>	5320 <sup>3</sup>	8250 <sup>4</sup>

**Key:**

1. Need not exceed  $\Delta_{h,A,B}(T_L)$  for the  $T_L$  value applicable for the location
2. Need not exceed  $\Delta_{h,C}(T_L)$  for the  $T_L$  value applicable for the location
3. Need not exceed  $\Delta_{h,D}(T_L)$  for the  $T_L$  value applicable for the location
4. Need not exceed  $\Delta_{h,E}(T_L)$  for the  $T_L$  value applicable for the location

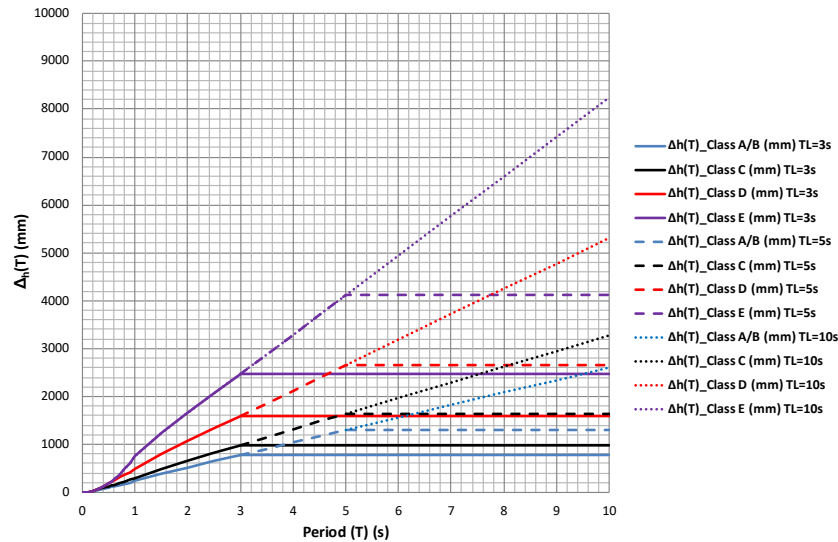

Figure 4-1: Displacement spectral shape factors  $\Delta_h(T)$  for the site subsoil classes and corner periods

Note that in Figure 4-1, blue is used for Class A/B, black for Class C, red for Class D and purple for Class E. The bold lines correspond to  $T_L=3s$ , with the dashed lines indicating the increased displacements for  $T_L=5s$  and the dotted lines the further increased displacements for  $T_L=10s$ .

#### 4.2.3 Limit states to be considered

The elastic site hazard acceleration and displacement spectra will generally need to be estimated for Serviceability Limit State 1 (SLS1), Serviceability Limit State 2 (SLS2) and the Ultimate Limit State (ULS) as defined in NZS 1170.5.

In addition, SLS2 requirements for operational continuity may be imposed for Importance Level 2 (IL2) and IL3 structures, at a level of shaking agreed between the designer and the client, not necessarily the 500-year return period level as required for IL4 structures. Amendment No. 1 of NZS 1170.5 (published 30 September 2016) introduced mandatory SLS2 provisions for some categories of parts in IL2 and IL3 structures (NZS 1170.5 Table 8). Also, the designer and the client may agree to consider a damage control limit state (DCLS) at which the structure is intended to have an agreed target level of damage after an agreed level of earthquake shaking.

Finally, the collapse avoidance limit state (CALS) is to be considered in which collapse avoidance is to be provided with reasonable reliability for a maximum hazard level as defined in terms of Equation 4-6 below. The key issues for isolated structures in this limit state are likely to be related to allowing for sufficient displacement of the isolators, including:

- sufficient width of seismic gaps and moat clearance or rattle space at the isolator level
- stability of isolator elements under maximum compression or tension loads at maximum displacements
- superstructure performance in loads beyond the ULS level – some limited level ductility of the superstructure may be required at this level of loading.

Further discussion is included in Chapter 6 Design.

#### 4.2.4 Hazard levels for assessment of collapse avoidance

The designer should obtain the hazard levels to be considered in determining the displacements and accelerations that must be sustainable without collapse by scaling the return period factor  $R_{CALS}$  for the collapse avoidance limit state (CALS) from the value  $R_u$  used for the ULS according to the following equation:

$$\begin{aligned}
 R_{CALS} &= 1.5 R_u / \alpha && \text{For buildings of Importance Level 2 and 3} \\
 R_{CALS} &= 1.3 R_u / \alpha && \text{For buildings of Importance Level 4}
 \end{aligned}
 \tag{Eq. 4-6}$$

Where:

- the robustness factor  $\alpha$  is given in Chapter 2 Table 2-2.

### 4.2.5 Acceleration-displacement format

The acceleration spectral shape factors  $C_h(T)$  defined in Section 4.2.1 and the displacement spectral shape factors  $\Delta_h(T)$  of Section 4.2.2 are presented as functions of each other in Figure 4-2 for the three corner periods  $T_L$  of 3s, 5s and 10s adopted for various parts of New Zealand (also refer Table 4-1). Figure 4-2 also shows loci corresponding to constant spectral periods  $T$ . The use of these curves in single degree of freedom acceleration displacement response spectra (SDOF ADRS) analysis is covered in Section 5.4, with limitations on its use given in the commentary to that section.

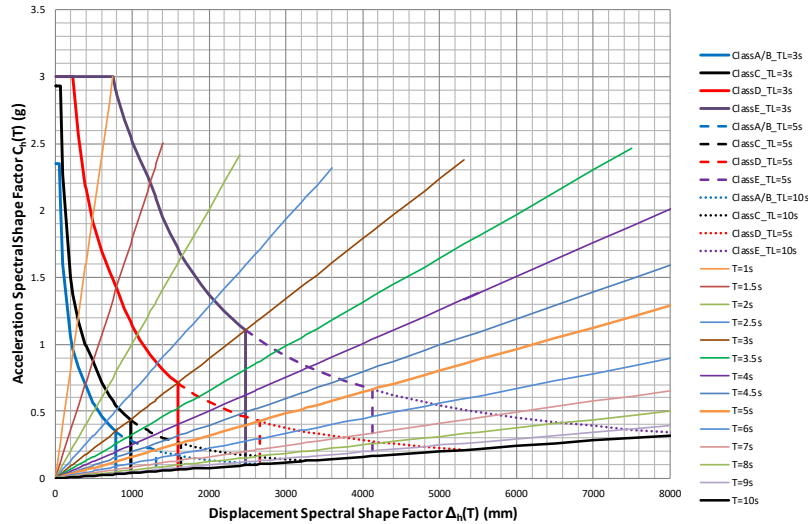

Figure 4-2:  $\Delta_h(T)$ - $C_h(T)$  plots for the site subsoil classes and corner periods

Note that in Figure 4-2 the bold lines correspond to  $T_L=3s$ , the dashed lines indicate the increased displacement spectral shape factors for  $T_L=5s$ , and the dotted lines the further increased displacement spectral shape factors for  $T_L=10s$ . The plots are for periods  $T$  up to 10s, so just reach the peak displacement values for the  $T_L=10s$  case. The plateau at the longest periods is not shown.

### 4.2.6 Vertical accelerations

The elastic site hazard spectrum for vertical loading shall be as defined in the revised Section 3.2 of NZS 1170.5 incorporating Amendment No. 1.

Section 5.7 on NITHA and its commentary discuss how the effects of the vertical motions should be taken into consideration.

## 4.3 Site-specific hazard studies

Generally, the requirements for site-specific studies are the same as those for conventional structures, as given in the relevant design document (e.g. NZS 1170.5 or the NZTA Bridge Manual). However, studies for seismically-isolated structures should recognise possible shortcomings at long periods of the ground-motion prediction equations (GMPE) used in the hazard analyses.

In particular, hazard spectra determined from site-specific studies should recognise the increase in the velocity-displacement corner period  $T_L$  from the default value of 3s assumed in NZS 1170.5. Depending on the GMPE models used, the site-specific spectra may not have sufficiently long  $T_L$ . If the corner period of the hazard spectrum is shorter than the  $T_L$  value given for the site location in Table 4-1, it should be shown that the GMPEs have corner periods for magnitudes and distances that make sizeable contributions to the estimated hazard at the site that are at least as long as that given by the expression

$$\log_{10}(T_L/3) = 0.5229*(M_w - 6.5) \tag{Eq. 4-7}$$

The determination of the corner period  $T_L$  for a given spectrum is discussed in the commentary to this section.

The corner period of the hazard spectrum for the return period of interest should be compared to the corner period given by Equation 4-7. The magnitude  $M_w$  to be used in Equation 4-7 shall be such that larger magnitudes produce no more than 20% of the estimated exceedance rate of the spectral acceleration for the period closest to the effective period  $T_{eff}$  of the system. Note that the moment magnitude  $M_w$  used to calculate  $T_L$  may be smaller

than that given in Table 4-1 if it is justified by deaggregation analysis, except that it may not be taken as less than 6.5 anywhere (i.e.  $T_L$  cannot be reduced below 3s). If the GMPE model does not satisfy this requirement on its corner period, the resulting hazard spectra should be modified by increasing spectral values for periods longer than 3s by the expressions

$$S_A(T) = S_A(3s) (3/T) \quad 3s \leq T \leq T_L \quad (\text{Eq. 4-8})$$

$$= S_A(T_L) *(T_L/T)^2 \quad T > T_L \quad (\text{Eq. 4-9})$$

## 4.4 Selection and scaling of ground motion records

This guideline provides for two different approaches to the selection and scaling of earthquake ground-motion records.

The first approach is based on using uniform hazard spectra (see the commentary to Section 4.5) as the target spectra, defined either by the NZS 1170.5 elastic site hazard spectra with adjustments for lengthening of the corner period  $T_L$  specified in Section 4.2.1 of this guideline, or from a site-specific hazard analysis. The modifications introduced for using this approach for seismically-isolated structures are to propose a lengthened period range for determining the scaling factor and measure-of-fit, relaxed requirements for the family scaling factor  $k_2$ , and an increase in the minimum number of records considered, as discussed in Section 4.4.1.

The second approach is a new alternative to the NZS 1170.5 approach, based on using conditional mean spectra or conditional spectra as the targets to be satisfied by the record selection and scaling, as discussed in Section 4.5 below. This guideline does not prescribe the details for such approaches, but merely notes that they are acceptable alternatives provided that adequate description and justification of the specific approach adopted is documented.

The vertical components should also be considered if the isolation system has any element or component that is sensitive to the amplification of vertical and gravity loadings, such as indicated in Section 5.7.4.

### 4.4.1 Modifications of UHS-based NZS 1170.5 procedures

Three main changes to the UHS-based NZS 1170.5 procedures for selecting and scaling accelerograms for response-history based design or evaluation are suggested for seismic isolation systems, while retaining the general approach of NZS 1170.5. In addition, two other requirements that are consistent with NZS 1170.5 but are often overlooked are reiterated. This is because of their importance for near-fault locations for which seismic isolation is often selected as the structural option.

#### Period range of interest

The recommended period range of interest for selecting and scaling accelerograms depends on whether or not the structure is well isolated in the elastic phase of response of the isolator (i.e. before yielding or sliding of the isolator occurs). Structures are considered well isolated in the elastic phase when the ratio of  $T_{1 \text{ elastic}}$  (the fundamental period for the isolated system during elastic phase response of the isolators) to the first-mode fixed-base superstructure period  $T_{1, \text{ fixed-base}}$  is 2 or greater in both horizontal directions.

For systems that are well isolated in their elastic phase of response, the recommended period range of interest is from the minimum of  $0.4 * T_{\text{eff}}$  and  $T_{1 \text{ elastic}}$  to  $1.2 * T_{\text{eff}}$ . The effective period  $T_{\text{eff}}$  is based on the effective (secant) stiffness for the limit state under consideration, as defined by Equation 5.11 in Chapter 5. In setting this period range, the effective period  $T_{\text{eff}}$  should be taken as its lower bound value for setting the minimum period, and as its upper bound value when considering the maximum period.

For systems with poor elastic-phase isolation (i.e.  $T_{1 \text{ elastic}} / T_{1, \text{ fixed-base}}$  less than 2), consideration should be given to reducing the minimum of the period range to the elastic-phase second-mode period  $T_{2 \text{ elastic}}$  of the superstructure-isolator system, provided that this is less than  $0.4 * T_{1 \text{ eff}}$ . Here  $T_{2 \text{ elastic}}$  in each direction is intended to represent the longest of the periods associated with modes with two antinodes (usually at the top and near one-third height) in the modal horizontal displacement profile up the structure when using the upper bound elastic-phase isolator stiffnesses.

The individual accelerograms are each scaled by their individual factors  $k_1$  such that the average of the logarithm of their 5% damped acceleration response spectrum matches the average of the logarithm of the target spectrum over the period range specified above, as in NZS 1170.5 apart from the modified period band. The target spectrum is  $(1 + S_{\text{p,iso}}) / 2$  times the elastic site hazard spectrum  $C(T)$ , where  $S_{\text{p,iso}}$  is the structural performance factor for the isolation system rather than that of the superstructure.

### Modified requirements for the family scaling factor $k_2$

The family scaling factor  $k_2 \geq 1.0$  shall be selected such that the envelope of the scaled record spectra (when there are fewer than seven records) or their average (when there are seven or more records) reaches or exceeds 0.9 times the target spectrum at all periods over the period range of interest.

### Number of records to be used

A minimum of three record pairs of scaled horizontal ground-motion accelerograms should be used.

- If three to six records are used, the design responses are to be taken as the largest of the maximum responses to the individual accelerograms, subject to the relaxation of this requirement for forward-directivity records as stated below (under Reduction of isolator displacements for strong forward-directivity records).
- If seven or more records are used, the design responses may be taken as the average of the maximum responses to the individual accelerograms.

When the site is within 20 km of any of the major faults identified in Section 3 of NZS 1170.5, at least one third of the accelerograms (rounded to the nearest integer) shall exhibit near-fault forward-directivity features, as required in Section 5.5 of NZS 1170.5.

These combinations are summarised in Table 4-3.

**Table 4-3: Suggested number of ground motion acceleration history records**

Condition	Method of computing results	Number of ground motion records
Far-field (>20km)	Average	Record pairs $\geq 7$
Far-field (>20km)	Maximum	$3 \leq \text{record pairs} \leq 6$
Near-fault ( $\leq 20\text{km}$ )	Average	Record pairs $N \geq 7$ Near-fault record pairs $\geq \text{ROUND}(N/3)$
Near-fault ( $\leq 20\text{km}$ )	Maximum	$3 \leq \text{Number of record pairs } N \leq 6$ Near-fault record pairs $\geq \text{ROUND}(N/3)$
<b>Notes:</b>		
Distances are from the closest of the faults requiring near-fault factors according to NZS 1170.5.		
ROUND = Round to nearest integer.		

### Orientation of records

For consistency with NZS 1170.5, this guideline imposes no constraint on the orientation required for either 'ordinary' or near-fault records. In practice, many near-fault records are provided in fault-normal and fault-parallel directions, particularly if they contain strong forward-directivity pulses. As in NZS 1170.5, the analyses should be performed first with the pair of horizontal records aligned in one direction and then in the orthogonal direction.

### Reduction of isolator displacements for strong forward-directivity records

When the maxima of the responses across all records are to be used, Clause 7.3.1.2 of NZS 1170.5 allows the inter-storey deflections calculated from records with strong forward-directivity characteristics to be scaled by 0.67. This scaling should also be applied to the estimated isolator displacements.

## 4.5 Conditional mean and conditional spectra methods

Acceptable alternative target spectra for accelerogram selection and scaling may be formulated using the conditional mean spectrum (CMS) or conditional spectra approaches, provided sufficient justification is provided for the derivation of the conditional target spectra and accelerogram selections to satisfy peer review. The documentation should include a description of the criteria used to select and scale the accelerograms, and demonstration that the selected accelerograms satisfy these criteria. When multiple conditional mean spectra are considered, the requirements of Table 4-3 should apply to the records selected for each CMS.



# COMMENTARY

Section	Commentary
<p><b>4.2</b></p> <p><b>4.2.1</b></p>	<p><b>Acceleration and displacement seismic demands</b></p> <p><b>Elastic site acceleration spectra for horizontal loading</b></p> <p>Recognising that the effective damping values of many seismic isolation systems are well in excess of the 5% of critical viscous damping associated with the elastic spectral shape factors of NZS 1170.5, a damping reduction factor has been included in the expression for the elastic site hazard spectrum in Equation 4.1. The damping modification expressions themselves are provided in Section 5.4 together with the requirements for determining the appropriate damping values.</p> <p>The damping reduction factor <math>B_{\xi}</math> is really a function of period <math>T</math> as well as effective damping <math>\xi_{\text{eff}}</math>, recognising that the zero period value of the acceleration response spectrum corresponds to the peak ground acceleration (PGA), which is not a function of damping. In reality, the reduction of the spectrum by damping will be a continuously varying function of period <math>T</math>, with the reduction usually greater near the peak of the spectrum. However, in many simple expressions for <math>B_{\xi}</math>, the period dependence will be manifested by the factor differing from 1.0 only over a period range that excludes <math>T=0</math>. Greater damping should only be considered for those first few modes where the response is dominated by the isolator motions.</p> <p>The acceleration spectral shape factors <math>C_h(T)</math> have been modified for all but the lowest seismic areas of New Zealand (i.e. Auckland and Northland) by increasing the corner period <math>T_L</math> at which the response spectrum changes from constant-velocity to constant-displacement behaviour, reflecting that the assumed corner period of 3s in NZS 1170.5 probably underestimates long-period spectral accelerations in many parts of the country. <math>T_L</math> depends on the moment magnitude <math>M_w</math>.</p> <p>The recommended values (McVerry et al., 2013) result from rounding values from the expression</p> $\log_{10}(T_L/3) = 0.5229*(M_w - 6.5)$ <p>The recommended <math>T_L</math> values in this guideline correspond to <math>T_L</math> values of 3s at magnitude 6.5, 5s at approximately magnitude 6.9 and 10s at magnitude 7.5. The magnitude 6.5 value of 3s is the <math>T_L</math> value used in NZS 1170.5, and corresponds to the Calvi et al. (2008) relation often used in displacement-based design in Europe, while the value of 10s for <math>M_w</math> 7.5 corresponds to that obtained by plotting the IBC code values (Crouse et al., 2006) at the middle of their magnitude ranges.</p> <p>The effect of the increased corner period is to increase the 5% damped acceleration and displacement demands for periods <math>T</math> between 3s and <math>T_L</math> by the factor <math>T/3</math>, and for periods greater than <math>T_L</math> by <math>T_L/3</math>.</p> <p>A simple method is used to determine the regions associated with each of the recommended <math>T_L</math> values of 3s, 5s and 10s. The constant-displacement part of the spectrum comes into play when considering ULS and beyond ULS motions, as it is unlikely to be reached for secant-stiffness based periods in SLS1. For simplicity, the magnitudes <math>M_w</math> used for calculating <math>T_L</math> around the country are based on the largest magnitudes that are likely to significantly affect the spectra estimated for return periods associated with collapse avoidance motions, nominally of about 2,500 years for IL2 structures to about 5,000 to 10,000 years for higher importance levels. Figure 6-3 of the NZTA Bridge Manual (2016) shows such a map. The magnitudes in each region have been derived by simply taking the largest magnitudes assigned to faults in the region that have recurrence intervals of rupture of less than 10,000 years, except for Northland and Auckland where magnitude 6.5 is that associated with the minimum ULS design event.</p> <p>The <math>M_w</math> 6.5 region of Figure 6-3 of the NZTA Bridge Manual corresponds approximately to Northland Regional Council and Auckland Council. The <math>M_w</math> 6.7 and <math>M_w</math> 6.9 regions correspond to the Waikato and Taranaki Regional Councils and the Western Bay of Plenty, Tauranga and Rotorua District Councils. <math>T_L=3</math>s is assigned to Northland Regional Council and Auckland Council, the <math>M_w</math> 6.7 and <math>M_w</math> 6.9 regions are combined to give <math>T_L=5</math>s for the Waikato and Taranaki Regional Councils and the Western Bay of Plenty, Tauranga and Rotorua District Councils, and <math>T_L=10</math>s is assigned to the rest of the country.</p> <p><math>T_L</math> is likely to increase further for increased magnitudes, but it is assumed in this guideline that periods longer than 10s are unlikely to be of interest. The adequacy of the adopted <math>T_L</math> should be assessed for isolation systems in which periods longer than 10s are of relevance. Further, information on the derivation of the corner periods <math>T_L</math> recommended in this guideline is provided in McVerry et al. (2017).</p>

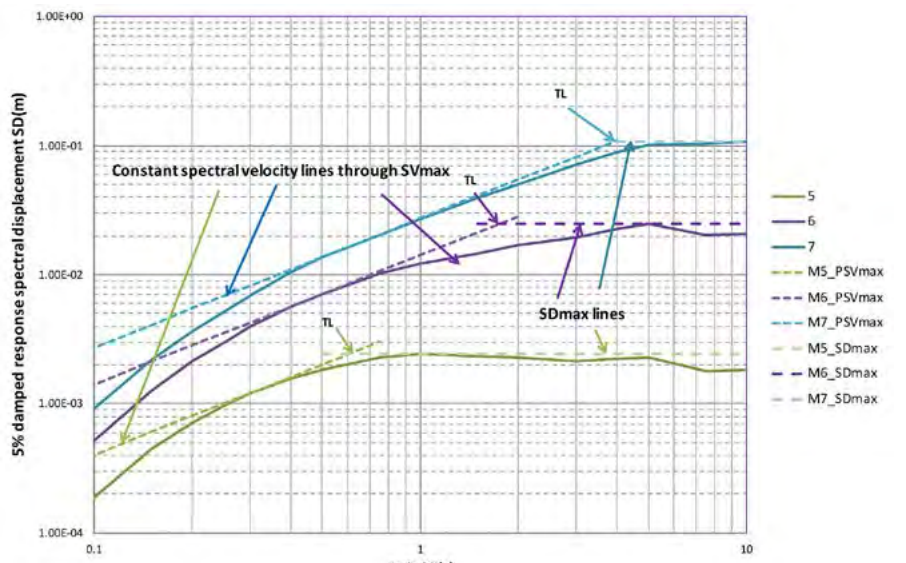
Section	Commentary
<p><b>4.2.4</b></p>	<p><b>Hazard levels for assessment of collapse avoidance</b></p> <p>In NZS 1170.5 there is an assumed factor of 1.5 between ULS motions and collapse avoidance. There is also a return period factor of 1.8 between 500-year motions, associated with the ULS for IL2 buildings, and 2500-year motions, often considered as corresponding to the CALS for these structures, although there is no requirement in NZS 1170.5 to specifically demonstrate that collapse will be avoided at this level of motion. However, this guideline recommends explicitly considering the displacements and accelerations that must be sustainable without collapse in motions stronger than the ULS, in the CALS. The robustness factor <math>\alpha</math> has been introduced in recognition of this requirement for explicit consideration of the CALS, and to reconcile the difference between the factors of 1.5 and 1.8. The factor of 1.5 has been reduced to 1.3 for IL4 structures in Eq. 4-6 to represent a commensurate increase in return period of hazard. For isolated buildings this will typically still give an increase in displacement demand at the isolation plane in excess of twice the ULS demand.</p> <p>The <math>\alpha</math> factor (Table 2-5) has been set at 1.2 for those seismically isolated systems that are expected to perform well in motions above ULS, even if the beyond-ULS displacement demands result in contact across the rattle space, because ductility capacity is incorporated in the superstructure. For potentially less well-behaved systems beyond ULS, where there is no inherent ductility in the superstructure (for example, as may occur for some structures with seismic isolation retrofits), <math>\alpha = 1.0</math> to satisfy the hazard demand, without any allowance for reduction of beyond-ULS demands by energy-dissipation mechanisms. Intermediate values of <math>\alpha</math> are assigned where the beyond-ULS performance lies between that expected of brittle superstructures and those with fully ductile design.</p>
<p><b>4.2.6</b></p>	<p><b>Vertical accelerations</b></p> <p>Amendment 1 of NZS 1170.5 provides new expressions for vertical acceleration spectra. These provide more realistic representations of vertical spectra than the original NZS 1170.5 specification that the vertical spectra are simply the horizontal spectra scaled by 0.7. They recognise that at near-source locations parts of the vertical spectrum may exceed the horizontal spectra, but only at short periods. A fuller discussion is provided in Commentary Clause C3.2 of NZS 1170.5 Amendment No.1.</p>
<p><b>4.3</b></p>	<p><b>Site-specific hazard studies</b></p> <p><math>T_L</math> may be determined for a given spectrum as the period of intersection of a constant spectral-velocity line drawn through the maximum 5% damped response-spectral velocity, with the line corresponding to the maximum 5% damped response-spectral displacement in the period range up to 10s (this will be the 10s displacement if a maximum is not reached by the 10s period).</p> <p>This procedure for determining <math>T_L</math> for a given spectrum as the period where the constant spectral velocity envelope intersects the maximum spectral displacement line is illustrated in Figure 4.3.</p>  <p><i>Figure 4-3: Determining <math>T_L</math> from intersection of <math>SD_{max}</math> and <math>SV_{max}</math> envelopes</i></p>

Section	Commentary
<p><b>4.4</b></p>	<p><b>Selection and scaling of ground motion records</b></p> <p>This section summarises the main changes to the NZS 1170.5 accelerogram selection and scaling approach suggested in this guideline. It includes a description of alternatives based on conditional mean spectra (CMS) or conditional spectra (CS) to the NZS 1170.5 uniform-hazard based spectra for defining target spectra for design. The relative merits of CMS or CS and the traditional uniform hazard spectra (UHS) for specifying design motions are explained, followed by references to publications and websites describing how to calculate conditional spectra and select appropriate ground-motion records to satisfy CMS or broader classes of conditional spectra and generalised conditional ground-motion measures.</p>
<p><b>4.4.1</b></p>	<p><b>Modifications of UHS-based NZS 1170.5 procedures</b></p> <p><b>Period range of interest</b></p> <p>For base-isolated buildings, an appropriate period to associate with the first-mode response is <math>T_{\text{eff}}</math>. This period is determined mainly by the characteristics of the isolation system and is virtually independent of the fixed-base period of the structure (provided that it is sufficiently less than the isolator period to allow effective isolation). The maximum period used for matching and scaling of records to the target spectrum is extended beyond <math>T_{\text{eff}}</math> to recognise that the tangent-stiffness based period near maximum displacement may be associated with a period significantly longer than the secant-stiffness-based <math>T_{\text{eff}}</math>. The maximum period of <math>1.2 * T_{\text{eff}}</math> is based on the maximum period of <math>1.3 * T_1</math> given in NZS 1170.5, with the factor of 1.3 reduced to 1.2 in recognition that <math>T_{\text{eff}}</math> includes lengthening from the initial period which is not accounted for in <math>T_1</math>.</p> <p>The minimum values for the period range of interest are intended to extend down to the period range that may produce response of the structure at periods that are much shorter than the effective period of the structure-isolator system. Such responses are expected during the elastic phases of isolator response (i.e. when the isolators are not yielding or sliding, depending on the isolator type). These responses are expected at the first-mode elastic period <math>T_{1 \text{ elastic}}</math> of the overall superstructure-isolator system irrespective of the degree of elastic-phase isolation, and in addition at the second-mode elastic period <math>T_{2 \text{ elastic}}</math> if elastic-phase isolation is poor.</p> <p>Poor elastic-phase isolation occurs when the ratio of <math>T_{1 \text{ elastic}}</math> (the fundamental period for the isolated system during elastic phase response of the isolators) to the first-mode fixed-base superstructure period <math>T_{1 \text{ fixedbase}}</math> is less than 2 for either horizontal direction (Skinner et al., 1993, pages 49, 139 and 177).</p> <p>In addition, the condition that the minimum value of the period range of interest should not exceed <math>0.4 * T_{\text{eff}}</math> is imposed. This is partly for consistency with NZS 1170.5, but is also important for linear or nearly linear isolation systems. This condition is unlikely to govern for nonlinear (yielding or sliding) isolation systems for ULS or CALS motions, but could occur in the rare cases where dynamic analysis is performed to check serviceability performance at low levels of motion only marginally above, or even below, the yield-level motions, for which <math>T_{\text{eff}}</math> may be close to <math>T_{1 \text{ elastic}}</math>. This condition also comes into play for linear or nearly linear isolation systems, for which <math>T_{\text{eff}}</math> will be similar to <math>T_{1 \text{ elastic}}</math>.</p> <p><b>Modified requirements for the family scaling factor <math>k_2</math></b></p> <p>As for NZS 1170.5, the procedures for deriving the record scale factors <math>k_1</math> for individual records require that the logs of the record spectrum and target spectrum match on average across the period range of interest. However, the requirements for the family scaling factor <math>k_2</math> have been relaxed from those of NZS 1170.5 in recognition that the period range for matching the target spectrum is likely to be broader than for a non-isolated structure. Accordingly, the envelope of the scaled spectra (when less than seven records are used) or their average is required to reach to only at least 0.9 times the target spectrum over all parts of the range. This requirement was proposed recently (Haselton et al., 2014) in the NEHRP recommendations for the average of 11 scaled records (the minimum required) for the ASCE design codes, in which the matching period range is also wider than in NZS 1170.5. This relaxation can be justified in that, when following the NZS 1170.5 provisions for selection and scaling of ground-motion records, it is often found that the <math>k_2</math> scaling factor is controlled by the requirements towards the extremities of the period range of interest.</p>

Section	Commentary
4.4.1	<p><b>Number of records to be used</b></p> <p>This guideline retains the NZS 1170.5 requirements of requiring at least three records, with the values of the design response parameters to be taken as the maximum values across the three records. However, this guideline allows the alternative of using seven or more records with the design response parameters averaged across these records. This alternative is strongly recommended to achieve better alignment with international guidelines, some of which require a minimum of 11 rather than seven records (FEMA, 2015).</p> <p>In reality, neither the maximum of three responses nor the average of seven is likely to provide the value of the design demand parameter required to meet an appropriate reliability. Bradley (2011, 2014) provides discussions of the relative merits of using the maximum responses from three records or the average responses from seven records, as well as a proposal of how to scale the responses to obtain appropriate design demands. These papers provide equations for adjusting the mean demand from N response history analyses to obtain the design demand value that delivers the required level of reliability.</p> <p><b>Orientation of records</b></p> <p>There is no change to the NZS 1170.5 requirement for one third of the records to exhibit strong forward-directivity characteristics at locations where near-fault factors need to be applied. The NEHRP recommendations (FEMA, 2015) require near-fault records to be oriented in fault-normal and fault-parallel directions. While there are no such requirements in this guideline or in NZS 1170.5, in practice many near-fault records are provided in these orientations, particularly if they contain strong forward-directivity pulses. The intention of the NEHRP directionality requirements is to ensure that the strong fault-normal component is aligned with the building axes. However, in practice the building axes may not be aligned fault normal and fault parallel, so rotating the records may lead to orientations that are inconsistent with the building alignment with the nearby fault. NZS 1170 has no comment on the orientation required for the near-fault records, although, as for 'ordinary' records, it requires the analyses to be performed first with the pair of horizontal records aligned in one direction and then in the orthogonal direction.</p> <p><b>Reduction of isolator displacements for strong forward-directivity records</b></p> <p>It should be noted that when using the maximum inter-storey deflection from a set of records including some with pronounced forward-directivity pulses, Clause 7.3.1.2 of NZS 1170.5 allows the maximum inter-storey deflections obtained from forward-directivity records to be scaled by 0.67.</p> <p>It has been found that when time history analyses are performed, the actions imposed on structures by forward-directivity records scaled to the spectra including near-fault factors are much greater than those from the modal response spectrum method including the same near-fault factors (Tremayne and Kelly, 2005). The 0.67 modification factor provides better consistency between results from the modal response spectrum analysis (MRSA) and numerical integration time history analysis (NITHA) methods. The same effect applies to the estimated isolator displacements, which should similarly be scaled by 0.67. The observation that the maximum larger-component displacements obtained from records incorporating near-fault pulses generally overestimate the target motions is part of the reason for preferring to use sufficient records to allow the use of average rather than maximum displacements from across the set of records. When averaging across the different records is applied, it appears that the excessive displacements from the forward-directivity records (which NZS 1170.5 requires to comprise about one third of the records) are averaged out over the records, so the reduction for forward-directivity records is not applied. The forward-directivity records have much reduced influence when the design values are selected by averaging across all records rather than by taking the maxima across all records.</p>
4.5	<p><b>Conditional mean and conditional spectra methods</b></p> <p>The uniform hazard spectrum (UHS) has been used as the target spectrum in New Zealand design practice for about 25 years, including in the formulation of the elastic site hazard spectra in both NZS 1170.5:2004 and its predecessor NZS 4203:1992. The uniform hazard spectrum is created for a given hazard level by selecting the results of probabilistic seismic hazard analyses (e.g. response spectral acceleration or SA for a given probability of exceedance, usually expressed in terms of a return period) individually for each spectral period. The UHS ordinates at any period are not associated with a given earthquake. Rather, they represent the level of shaking estimated for a given exceedance rate from the combined contributions of many magnitude-distance sets. However, the uniform-hazard spectral</p>

Section	Commentary
<p><b>4.5</b> <i>Continued</i></p>	<p>values at each period are unlikely to all occur in a single ground motion, and for low exceedance probabilities (i.e. long return periods) the probability of observing all of those spectral amplitudes in any single ground motion is considerably less than the probability of exceedance associated with the individual spectral ordinates of the UHS. Accordingly, the UHS is inherently conservative in terms of specifying the demands on a structure from a single earthquake for long return-period motions.</p> <p>The CMS approach tackles this problem with UHS by taking a single important spectral period (the ‘conditioning period’) on the UHS for the return period of interest (e.g. at the fundamental period) and estimating the mean values of the accelerations at other spectral periods that are expected to occur in the same event as the acceleration at the conditioning period, taking into account the degree of correlation between accelerations at different spectral periods. The correlation will be high for periods near the conditioning period and small for periods well separated from the conditioning period. The CMS can be used to generate alternatives to the UHS as target spectra for the selection and scaling of accelerograms. The various ordinates of the CMS are likely to occur in combination with the spectral acceleration at the conditioning period with a probability similar to the target probability. The spectral shapes of the ground motions selected to match the CMS will have a spectral shape consistent with naturally occurring ground motions for the site of interest (FEMA, 2015).</p> <p>This approach was proposed by Baker and Cornell (2006). Baker (2011) provides a good description of the approach and its application, discussing CMS for both the simplest case, where a single event clearly dominates the hazard, and for the next level of complexity, where multiple earthquake scenarios make significant contributions. The proposal for the multiple scenario case is to calculate the average magnitude and distance of the contributions, and then use these values to define the (M,R) combination appropriate for calculating the CMS. Criteria for the selection and scaling of accelerograms are also discussed. Baker notes that it is usual to consider two or more conditioning periods and calculate CMS for each of them.</p> <p>The single or multiple event situations with multiple conditioning periods are covered in the NEHRP 2015 recommended provisions (FEMA, 2015) by Method 2 for defining the target spectrum.</p> <p>The concept has been expanded to generate the CS associated with the same CMS but also specifying the probability distribution of accelerations around the CMS. Baker (2011) discussed this extension, for which Jayaram et al. (2011) provided a computational procedure. Conditional spectra have also been proposed for higher levels of complexity where multiple scenarios are considered, possibly in association with multiple ground-motion prediction equations as well (e.g. Ebrahimian et al., 2012; Lin et al., 2013). While conditional spectra have been used in reliability assessments of structures, these higher levels of complexity do not appear to have been incorporated in seismic design codes as yet.</p> <p>Hasash et al. (2015) discuss the use of the CMS approach in a situation where the spectral accelerations at short and long spectral periods are governed by very different events: a moderate magnitude local event for short periods, and a large magnitude distant earthquake at long periods. Ay et al. (2017) discuss practical limitations to using CMS, mainly relating to lack of the required hazard deaggregation information.</p> <p>For base-isolation applications, one conditioning period will usually be near the effective period <math>T_{eff}</math> of the base-isolated system for the limit state under consideration. A second period that may be important is that of the second mode of the isolated system, for which the associated frequency (the inverse of the period) is around the average of the fixed-base first and ‘second’ mode frequencies, where the ‘second’ mode is the lowest-frequency mode that exhibits a node in its profile up the structure (i.e. with a displacement profile up the structure that is similar to that of the second mode from a simple model in which each floor is represented by a single mass, with floors separated by spring elements). For sites having a strong impedance contrast that produces strongly peaked ground-motion spectra, an additional conditioning period near the site period may also be appropriate.</p> <p>An even more sophisticated procedure has been proposed and implemented by Bradley (2010, 2012), utilising a generalised conditional intensity measure (GCIM) procedure. This procedure simultaneously matches not only spectral ordinates at different periods, but also includes parameters such as PGA, peak ground velocity (PGV), Arias Intensity, significant duration and other measures, making use of the correlation structure between various of these hazard parameters. Bradley provides online and open-source software for using the GCIM procedure to obtain accelerograms that match the specified criteria.</p> <p>(Refer <a href="https://sites.google.com/site/brendonabradley/software/ground-motion-selection-gcim">https://sites.google.com/site/brendonabradley/software/ground-motion-selection-gcim</a> ).</p>





**nzsee**  
NEW ZEALAND SOCIETY FOR  
EARTHQUAKE ENGINEERING

## 5. ANALYSIS REQUIREMENTS AND METHODS

<b>CHAPTER CONTENT</b>	<b>PAGE</b>
5.1 Overview .....	56
5.2 Selecting the analysis method .....	56
5.3 General requirements .....	57
5.4 Single degree of freedom analysis .....	58
5.5 Equivalent static analysis.....	62
5.6 Modal response spectrum analysis.....	66
5.7 Nonlinear time history analysis.....	68
5.8 Analysis of part of a building, and floor response spectra.....	70
Commentary .....	71

## 5.1 Overview

This chapter sets out the requirements for the seismic structural analysis of isolated buildings. It covers both linear and nonlinear analysis methods. The analysis outputs are used to design the seismic isolation system, superstructure and substructure.

The method of analysis to be used is determined based on the isolated building type as specified in Chapter 2. While the type of system specifies the minimum analysis requirements for the detailed design verification, the simpler analyses are generally very useful in the earlier design phases and provide a means of verifying the more complex analyses.

## 5.2 Selecting the analysis method

The following methods are considered appropriate for the structural analysis of buildings with seismic isolation, depending on the conditions set out later in this chapter:

- single degree of freedom (SDOF) analysis
- equivalent static analysis (ESA)
- modal response spectrum analysis (MRSA)
- numerical integration time history analysis (NITHA).

The SDOF analysis method is generally the first step in the seismic isolator design process and is applicable to all isolated building types.

NITHA can be used for design verification of any isolated building type. It is expected that linear ESA or MRSA will be used for preliminary design and sizing of the superstructure and substructure.

Table 5-1: Required methods of analysis summarises the minimum requirements for selecting the analysis method. More detail on the limitations of each method follows later in this chapter.

The selection of analysis method, assumptions and criteria should be reviewed by and agreed with the peer reviewer.

**Table 5-1: Required methods of analysis**

Type of isolation system <sup>1</sup>	Type 1 (Simple)	Type 2 (General)	Type 3 (Complex or Ductile)	Type 4 (Brittle)
<b>Permissible methods of analysis</b>	Equivalent static analysis (ESA) recommended All methods of analysis are permissible	Modal response spectrum analysis (MRSA) is recommended Nonlinear time history analysis (NITHA) is permissible	NITHA verification is required	ESA if it meets all Type 1 requirements MRSA if it meets all Type 2 requirements NITHA is required if there is inelastic response
<b>Soil-structure interaction (SSI) influence</b>	Not required	Required	Required	Required
<b>Irregularity</b>	Requires regularity <sup>2</sup>	Limited <sup>3</sup>	No limitation	No limitation
<b>Flexibility of superstructure</b>	$T_{eff} > 3 \times T_{1, fixed-base}$	$T_{eff} > 3 \times T_{1, fixed-base}$	No limitation	$T_{eff} > 3 \times T_{1, fixed-base}$
<b>Uplift of isolator</b>	Not permitted	Allowed <sup>3</sup>	Allowed	Allowed <sup>3</sup>
<b>SITE CONDITIONS</b>				
<b>Site subsoil classification</b>	Class A to D	Class A to D	All subsoil <sup>4</sup>	All subsoil <sup>4</sup>
<b>Near-fault effects</b>	$N(T,D) = 1.0$	$N(T,D) \geq 1.0$	$N(T,D) \geq 1.0$	$N(T,D) \geq 1.0$



**Table 5-1: Required methods of analysis (Continued)**

<p><b>Notes:</b></p> <p>All criteria should be assessed based on ULS limit state and nominal isolator properties.</p>
<p><b>Key:</b></p> <ol style="list-style-type: none"> <li>1. The designer's choice of analysis method is determined by the type of isolated buildings (refer to Chapter 2) and the limitation of the analysis methods as set out in the respective sections within this chapter.</li> <li>2. Structural irregularity shall be considered in accordance with NZS 1170.5 and the minimum design action for the superstructure should be scaled accordingly.</li> <li>3. The significance of net tension or uplift of bearings/isolators on the lateral response of the system should be evaluated to confirm whether NITHA are required. The significance of net tension can be considered as acceptable when the tensile actions occur on units carrying less than 5% of the isolation system design gravity loading (5% of G+Qu load combination), without these tensile actions/uplift will imply failure with loss of vertical load bearing capacity of any device.</li> <li>4. For sites with soil class E, it is recommended that a site-specific special study is undertaken to understand the ground period and potential for dynamic resonance with the isolated structure. Site-specific response spectra shape may be warranted in some scenarios.</li> </ol>

## 5.3 General requirements

### 5.3.1 Isolation system properties

The analysis should be evaluated separately for upper-bound and lower-bound isolation system properties and the more restrictive requirement should govern.

The design actions for the superstructure and substructure is likely to be based on the upper bound properties. Meanwhile, the inter-storey drift and the maximum CALS lateral displacement should be based on the lower bound properties.

### 5.3.2 Mass eccentricity and torsion effects

Torsional response resulting from lack of symmetry in mass and stiffness should be accounted for in the analysis.

For linear analysis (equivalent static analysis and modal response analysis), an additional accidental mass eccentricity of +/-0.05 times the plan dimension of the building (at right angles to the direction of loading) should be applied to the superstructure from the calculated centre of mass at each level including the isolated level.

For numerical integration analysis (NITHA), the analysis model should capture torsional behaviour of the structure directly. An accidental mass eccentricity of +/- 5% should be applied at each floor.

The effects associated with the accidental eccentricity should be evaluated based on the procedures outlined in NZS 1170.5.

### 5.3.3 P-delta effects

Global and local P-delta effects should be considered in all analysis methods. If not explicitly modelled, the maximum local P-delta induced demand above or below the isolator planes can be determined using static analysis assuming axial load demand corresponding to the most adverse case of  $G + Qu \pm EQ$  acting on the isolators.

Analysis for P-delta effects should be considered explicitly on the isolators and their connections to adjacent structure above and below.

### 5.3.4 Soil-structure interaction

The effect associated with the flexibility of the foundation should be considered and design assumptions justified.

The effect of foundation flexibility should be incorporated in the structural model for class D/E soil class categories. A site-specific hazard study is required for class E soil conditions.

## 5.4 Single degree of freedom analysis of the isolation system

### 5.4.1 SDOF ADRS analysis method

The SDOF analysis and design process is iterative. The key steps for the SDOF acceleration-displacement response (ADRS) analysis are as follows:

#### Step 1: Compute the force-displacement capacity curve of the isolation system

Assume a starting design point for the isolation system including the layout, number, type and properties of isolators.

The capacity curve is defined as the force-displacement response of the isolation system as a whole, with the displacement being the centre of mass (COM) value. This curve is then converted into acceleration vs displacement, dividing the shear force by the effective mass ( $m_e$ ), which should include all components above the isolation system.

The output is a SDOF system equivalent acceleration vs displacement capacity curve.

$$S_{a, \text{capacity}} = V_{\text{capacity}} / \text{Total effective seismic mass above the isolation zone} \quad (\text{Eq. 5-1})$$

$$S_d = \text{Lateral displacement above the isolation zone} \quad (\text{Eq. 5-2})$$

Effective mass may generally be taken as being the total mass of all building components above the isolation plane. The procedure for calculating the capacity curve of the various isolation systems is out of the scope of this chapter. Users should refer to available literature such as Kelly et al. (2010).

Both curved surface friction isolators and elastomeric (including lead rubber) isolators would be treated as hysteretic dampers, and have different relationships for  $K_{d,e}$ .

#### Step 2: Determine the 5%-damped ADRS demand curves from NZS 1170.5

Determine the 5%-damped ADRS demand curve based on Chapter 4 and NZS 1170.5 seismicity for the site. The structural performance factor  $S_p$  is assigned based on the isolated structure type (Chapters 2 and 6).

#### Step 3: Design displacement and performance point iteration

The SDOF analysis process requires an iteration of the performance point, with the effective stiffness of the system ( $K_{d,e}$ ) and overall equivalent viscous damping obtained as the final outcome at the intersection of the response and demand curves. The iterative process includes the following:

- Select an arbitrary starting lateral displacement,  $\Delta_d$ .
- Evaluate the effective period of the system given the seismic isolation design (from Step 1):

$$T_{eff} = 2\pi \sqrt{\frac{W}{gK_{eff}}} \quad (\text{Eq. 5-3})$$

Where:

$W$  = building seismic weight (assuming G+Qu) loading, in kg

$g$  = gravity constant in m/s<sup>2</sup>

$K_{eff}$  = effective stiffness of the seismic isolation system, in kg/m

- Determine the spectral displacement based on the site displacement demand and the effective period. This requires the modified spectra displacement spectrum, accounting for the damping of the SDOF system (see step 4).
- Iterate the effective period and spectral displacement until a convergence is reached with  $\Delta_d = S_d$ . The design will need to be iterated for all the design limit states including SLS, ULS and CALS. This is illustrated in Figure 5-1 below.

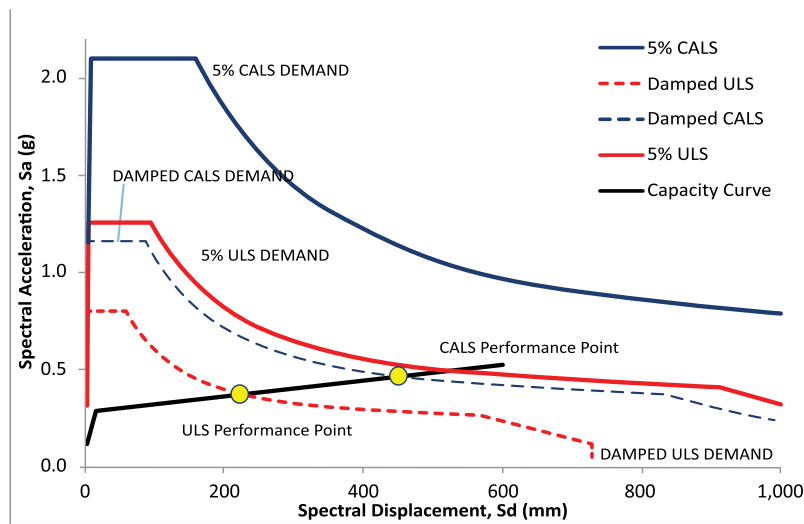

Figure 5-1: Seismic isolation system SDOF capacity and ADRS demand curves

**Step 4: Compute the spectral reduction factors for damping as a function of isolator system displacement (ULS and CALS)**

The isolator system effective damping ( $\xi_{e,i}$ ) should be established as the area-based damping at the demand displacement, as shown below:

$$\xi_{e,i} = \frac{1}{2\pi} \left( \frac{A_h}{K_{eff}\Delta^2} \right) \tag{Eq. 5-4}$$

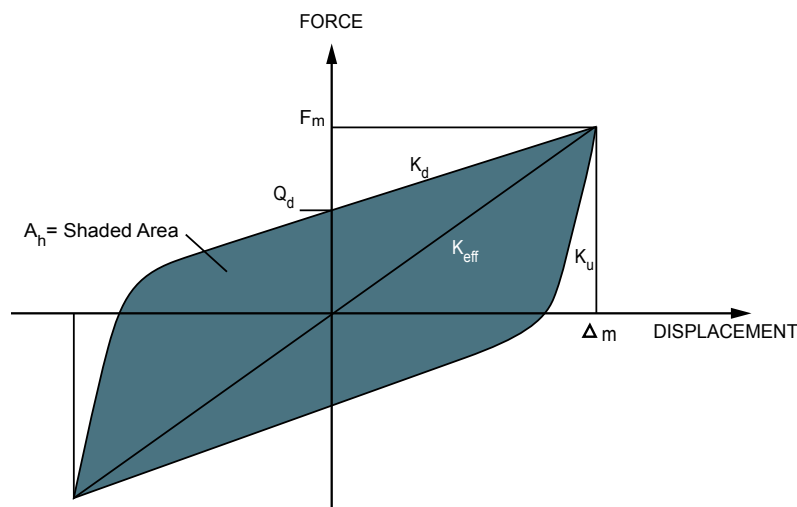

Figure 5-2: Calculation of system damping for a generic isolation system

The equivalent damping should be compatible with the properties of the system adopted in the analysis. An iterative process is required to ensure consistency is obtained between assumptions and outcomes. The 5%- damped spectrum can then be scaled by the  $B_\xi$  factor:

$$B_\xi = \left( \frac{0.07}{0.02 + \xi_{sys}} \right)^{0.5} \tag{Eq. 5-5}$$

where:

$\xi_{sys}$  = system equivalent viscous damping

In order to account for the contribution of the structural performance factor the design spectrum for the SDOF analysis, in accordance with the displacement-based design approach adopted, should be scaled by a factor equal to  $(1+S_p)/2$  (Marriott, 2017).

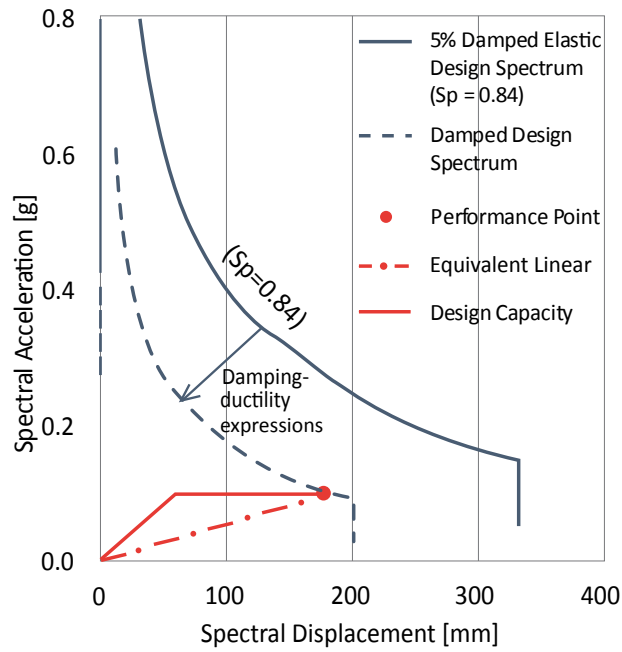

Figure 5-3: Scaling of ADRS curve

For the isolation plane design of systems where the deformation of the superstructure is not negligible, the analysis and the evaluation of the equivalent damping should take due account of the deformations of the superstructure, as outlined below, with reference to direct displacement-based design (DDBD) principles (Priestley et al., 2007).

Superstructure damping,  $\xi_{e,s}$  can be assumed to be 5% if it is expected to respond elastically or within nominally ductile demand. Therefore, the system equivalent viscous damping,  $\xi_{sys}$  can be computed using the following equation:

$$\xi_{sys} = \frac{\xi_{e,s}\Delta_{d,es} + \xi_{e,i}\Delta_i}{\Delta_{d,es} + \Delta_i} \quad (\text{Eq. 5-6})$$

where:

$\xi_{e,s}$  = equivalent viscous damping due to energy dissipation in the superstructure system

$\xi_{e,i}$  = isolator system effective damping

$\Delta_{d,es}$  = design displacement of the superstructure system

$\Delta_i$  = design displacement of the isolation system

Refer to Figure 5-4 below.

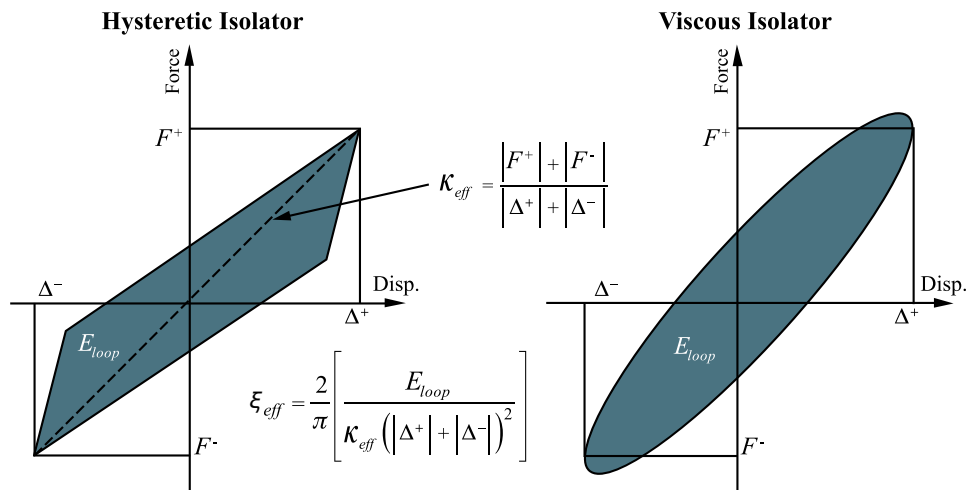

Figure 5-4: Linearisation procedure for typical isolators

### Step 5a: SDOF system response at performance point

Once convergence is achieved, the effective spectral acceleration (and base shear), and the effective spectral displacement (and the maximum design displacement) will need to be assessed. Further, the isolator system will need to be assessed to determine if the appropriate material limits have been exceeded. If necessary, the seismic isolation system design parameters will need to be changed and Steps 3 and 4 reiterated.

Refer to Chapter 6 for further discussion on the use of SDOF analysis for isolator design.

### Step 5b: Design SDOF displacement

The isolation system should be designed to withstand, as a minimum, the maximum CALS displacement,  $D_M$ , in the most critical direction of horizontal response, calculated using:

$$D_M = \frac{g S_{am,TDm} T_{Dm} B_\xi}{4\pi^2} \quad (\text{Eq. 5-7})$$

where:

$g$  = acceleration due to gravity, in units of  $(\text{mm}/\text{s}^2)$  if the units of the displacement  $D_M$  are in  $(\text{mm})$

$S_{am,TDm}$  = CALS 5%-damped spectral acceleration parameter at the period,  $T_{Dm}$ , in units of  $g$

$T_{Dm}$  = effective period of the seismically isolated structure in seconds at the displacement  $D_M$  in the direction under consideration

$B_\xi$  = calculated by Equation 5-5, based on the equivalent viscous damping of the whole system (building and isolator devices at the maximum design displacement,  $D_M$ )

$\Delta_d = S_d$  = design displacement of SDOF isolation system above isolation plane --> use for base shear calculation

$D_M$  = maximum displacement of SDOF isolation system at CALS --> use to check material deformation limits of isolators

$D_{TM}$  = max displacement at isolation plane accounting for torsion/plan dimension --> use to size clearance

if superstructure is flexible, then  $\Delta_{d,es}$  = design displacement of superstructure, and  $\Delta_i$  = design displacement of isolation only --> use to calculate combined damping eq 5-6.

The total maximum displacement,  $D_{TM}$ , of elements of the isolation system should include additional displacement due to actual and accidental torsion calculated from the spatial distribution of the lateral stiffness of the isolation system and the most disadvantageous location of eccentric mass. The torsional effects in the individual isolator units may be accounted for by amplifying in each direction the action effects defined in (Eq. 5-5) and (Eq. 5-6) with a factor  $\delta_{xi}$  given (for the action in the  $i$  direction) by:

$$\delta_{xi} = 1 + \frac{e_{tot}}{r_y^2} y_i \quad (\text{Eq. 5-8})$$

where:

$y_i$  is the dimension of horizontal direction transverse to the direction  $x$  under consideration

$(x_i, y_i)$  are the co-ordinates of the isolator unit  $i$  relative to the effective stiffness centre

$e_{tot,y}$  is the total eccentricity in the  $y$  direction

$r_y$  is the torsional radius of the isolation system in the  $y$  direction, as given by the following expression:

$$r_y^2 = \frac{\sum (x_i^2 k_{yi} + y_i^2 k_{xi})}{\sum k_{xi}} \quad (\text{Eq. 5-9})$$

$k_{xi}$  and  $k_{yi}$  being the effective stiffness of a given unit  $i$  in the  $x$  and  $y$  directions, respectively.

The total maximum displacement,  $D_{TM}$ , shall not be taken as less than 1.15 times  $D_M$ .

$$D_{TMi} = D_M \delta_{xi} \quad (\text{Eq. 5-10})$$

**Step 5c: SDOF base shear**

The design base shear should be defined on the basis of the effective mass ( $m_e$ ), taken as the total mass of the structures above the isolation plane. The effective mass may be refined using modal response spectrum analysis in a subsequent design phase.

The effective stiffness of the system ( $K_{d,e}$ ) is based on the effective period  $T_d$  at the maximum design displacement ( $\Delta_d = D_M$ ).

$$K_{d,e} = \frac{4\pi^2 m_e}{T_d^2} \quad (\text{Eq. 5-11})$$

$$V_{base} = K_{d,e} \Delta_d \quad (\text{Eq. 5-12})$$

For the purpose of designing the superstructure above the isolation plane, the following design base coefficient, can be used:

$$C_{d,isolated} = \frac{V_{base}}{m_e g} \quad (\text{Eq. 5-13})$$

**Step 6: Design the superstructure by distributing the SDOF base shear**

Once the SDOF seismic isolation system design is satisfactory, the superstructure can be analysed by applying the SDOF base shear as a loading to the superstructure. The required analysis technique for the superstructure is based on the isolated building type (refer Chapter 2) and the analysis requirements (refer Section 5.2).

## 5.5 Equivalent static analysis of the superstructure

### 5.5.1 General requirements

Equivalent static analysis (ESA) is generally adequate for isolated structures when:

- regular
- dominated by a single translational mode of vibration, and
- where the isolation system can be represented through an equivalent linear model.

### 5.5.2 Modelling requirements

#### Design displacement

These requirements are the same as for SDOF analysis.

The lateral displacement of the superstructure should be calculated as per NZS 1170.5. For the purpose of determining the drift modification factor  $k_{dm}$  the height of the building can be considered from the isolation plane.

#### Design base shear

The design base shear for the seismic isolation system and all the structure below the isolation plane is as calculated in the SDOF analysis for  $V_{base}$  in Equation 5-12.

The design base shear for the structure above the isolation plane can be considered as two scenarios:

1. the unreduced design base shear considering the effective seismic weight of the structure above the isolation interface -  $V_{st}$
2. the reduced design base shear considering the effective seismic weight of the structure above the isolation interface, excluding the effective seismic weight of the base level (e.g. ground floor slab) -  $V_s$

Both  $V_{st}$  and  $V_s$  are calculated based on the design base coefficient for the superstructure as calculated by Equation 5-13, and are dependent on the seismic mass participation:

$$V_{st} = C_{d,isolated}W \quad (\text{Eq. 5-14})$$

$$V_s = C_{d,isolated}W_s \quad (\text{Eq. 5-15})$$

where:

$W$  = effective seismic weight, in kN, of the structure above the isolation interface

$W_s$  = effective seismic weight, in kN, of the structure above the isolation interface, excluding the effective seismic weight, in kN, of the base level

The design horizontal forces for the ESA should be based on the upper-bound properties for the isolation system and the ULS level in accordance with Chapter 6. The effects associated with higher modes are considered through the adoption of multiple design force distributions, as specified below.

The isolation design is based on nominal isolator properties, with specific checks made using upper and lower bound adjustments. The isolation ULS period and displacement estimation will be determined from the nominal properties, with these values being used to review isolation plane effective stiffness and reliable restoring force. Subsequent checks for isolation maximum CALS displacement are based on lower-bound properties, and superstructure design forces derived from ULS upper bound isolator properties.

The value of  $V_s$  shall not be taken as less than each of the following:

- the lateral seismic force required for a fixed-base structure of the same effective seismic weight,  $W_s$ , and a period equal to the period of the isolation system using the upper bound properties
- the base shear corresponding to the factored design wind load,  $W_w$ , calculated in accordance to NZS 1170.2.

### Distribution of seismic horizontal forces

The ESA design actions for the superstructure should be obtained from the outputs envelope of the following four scenarios (refer Figure 5-4 for methods B, C and D):

- **Method A:** equivalent static forces for the fixed based building, as per NZS 1170.5, with a total base shear equal to the upper bound strength of the isolators at yield (i.e.  $Q_d$ )
- **Method B:** a linear (triangle) distribution of the design base shear obtained for the isolated building:

$$F_{mx} = C_{vx}V_s \quad (\text{Eq. 5-16})$$

where:

$$C_{vx} = \frac{w_x h_x}{\sum_{i=1}^n w_i h_i} \quad (\text{Eq. 5-17})$$

- **Method C:** a uniform distribution of the design base shear obtained for the isolated building:

$$F_{mx} = C_{vx}V_s \quad (\text{Eq. 5-18})$$

where:

$$C_{vx} = \frac{w_x}{\sum_{i=1}^n w_i} \quad (\text{Eq. 5-19})$$

- **Method D:** For buildings with three storeys or less, the following revised equations (York and Ryan, 2008; ASCE-7-16) can be used. These equations provide a better approximation of the lateral load distribution for low rise buildings where the seismic mass is dominated by the base slab weight.

The total unreduced lateral seismic force or shear on elements above the base level shall be determined using upper-bound and lower-bound isolation system properties, as shown in Equation 5-20:

$$V_{st} = V_b \left( \frac{W_s}{W} \right)^{(1-2.5\xi_{sys})} \quad (\text{Eq. 5-20})$$

where:

$V_b$  = base shear of the SDOF isolation system

$W$  = effective seismic weight, in kN, of the structure above the isolation interface

$W_s$  = effective seismic weight, in kN, of the structure above the isolation interface, excluding the effective seismic weight, in kN, of the base level

$\xi_{sys}$  = the effective damping of the isolation system at the maximum displacement

For isolation systems whose hysteretic behaviour is characterised by an abrupt transition from pre-yield to post-yield or pre-slip to post-slip behaviour, the exponent term  $(1-2.5\xi_{sys})$  in Equation 5-20 shall be replaced by  $(1-3.5\xi_{sys})$ .

The vertical distribution of loads is given by:

$$F_1 = V_b - V_{st} \quad (\text{Eq. 5-21})$$

$$F_{mx} = C_{vx} V_s \quad (\text{Eq. 5-22})$$

$$C_{vx} = \frac{w_x h_x^k}{\sum_{i=1}^n w_i h_i^k} \quad (\text{Eq. 5-23})$$

$$k = 14\xi_{sys} T_{1, \text{fixed-base}} \quad (\text{Eq. 5-24})$$

where:

$V_b$  = base shear of the SDOF isolation system

$V_{st}$  = base shear for superstructure above the isolator plane

$F_1$  = lateral seismic force, in kN induced at Level 1, the base level

$F_{mx}$  = lateral seismic force, in kN induced at Level x,  $x > 1$

$C_{vx}$  = vertical distribution factor

$V_s$  = superstructure design base shear

$w_i, w_x$  = portion of seismic weight that is located at or assigned to Level i or x

$h_i, h_x$  = height above the isolation interface of Level i or x

$\xi_{sys}$  = effective damping of the system  $R_\xi$  at the design displacement. Refer to  $B_\xi$  in Equation 5-6.

$T_1$  = the fundamental period, in s, of the superstructure above the isolation interface determined using a rational modal analysis assuming fixed-base conditions

Torsional effects should be considered as outlined in Section 5.3.2.



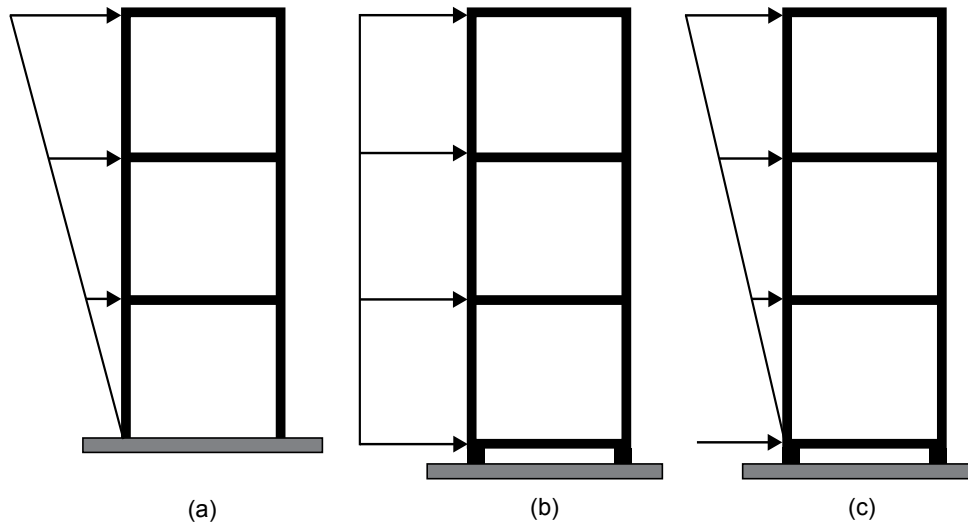

Figure 5-5: Vertical distribution of lateral forces (York and Ryan, 2008)

Figure 5-5 shows vertical distribution of lateral forces for: a) a fixed-base building based on a linear first mode shape, b) an isolated building based on uniform first mode shape, and c) an isolated building based on the modified design force distribution.

### Concurrency of seismic actions

The design of the isolation system and of the superstructure should account for the effects associated with the concurrent application of two orthogonal ground motion components along the two building axes (orthogonal to each other). The combined effects should be evaluated through two action sets, as outlined below:

- one action set obtained from 100% of the demand obtained from the earthquake input along the first axis (X) and 30% of the demand obtained from the earthquake input along the second axis (Y)
- one action set obtained from 100% of the demand obtained from the earthquake input along the second axis (Y) and 30% of the demand obtained from the earthquake input along the first axis (X).

### Torsion amplification

The displacement demand at the edge/corner of the building, as calculated by the ESA method, should be amplified by the following factor:

$$P_r = \frac{1}{r_i} \sqrt{\frac{\sum_{i=1}^N (x_i^2 + y_i^2)}{N}} \quad (\text{Eq. 5-25})$$

where:

$x_i, y_i$  = horizontal distances in ft (mm) from the centre of mass to the  $i^{\text{th}}$  isolator unit in the two horizontal axes of the isolation system

$N$  = number of isolator devices

$r_i$  = radius of gyration of the isolation system in ft (mm), which is equal to  $((b^2 + d^2)/12)^{1/2}$  for isolation systems of rectangular plan dimension,  $b \times d$

$b$  = the shortest plan dimension of the structure in ft (mm) measured perpendicular to  $d$

$d$  = the longest plan dimension of the structure in ft (mm) measured perpendicular to  $b$

The total maximum displacement,  $D_{TM}$ , shall not be taken as less than 1.15 times  $D_M$ .

## 5.6 Modal response spectrum analysis

### 5.6.1 General requirements

Modal response spectrum analysis (MRSA) can be used for isolated structures with a limited irregularity superstructure designed to elastic or nominally ductile demands. As for ESA, it relies on the assumption that the isolation system and superstructure can be represented through an equivalent linear model.

#### Spectral reduction-damping

MRSA requires isolator devices to be modelled using amplitude-dependent values of effective stiffness and damping that are essentially the same as those used for the ESA method. Increased damping associated with the isolation system should be applied only in the first few isolated modes. The damping level associated with higher modes of response should reflect that of a fixed base superstructure.

The equivalent system damping should be incorporated in the MRSA as a reduced ('damped') spectrum (referred to here as RSA damped spectrum), where the 5% ordinates are reduced by the equivalent damping factor for periods at least 0.8 times the effective ('secant') period of the isolation system. The latter should be compatible with the properties of the system adopted in the analysis. An iterative process is required to ensure consistency is obtained between assumptions and outcomes.

The effective damping ratio for the isolation system can be computed using the same method as for the ESA and SDOF methods.

#### Minimum design action

Scaling of the MRSA design actions should be performed in accordance with NZS 1170.5 and the recommendations in Chapter 4.

For superstructure classified as irregular, the base shear is at least 100% of the minimum design base shear for superstructure. For superstructure classified as regular, the design actions (forces and displacements) shall be scaled so that the base shear is at least 80% of the minimum design base shear for superstructure.

#### Isolator stiffness properties

Analysis should be evaluated separately for upper-bound and lower-bound isolation system properties and the more restrictive requirement should govern. Some isolation properties vary depending on system displacement and level of axial load. There is a need for iteration to ensure convergence of the assumed isolator parameters and the final design outcome.

#### Bi-directional load combination

Response-spectrum analysis used to determine the lateral displacement should include simultaneous excitation of the model by 100% of the ground motion in the critical direction and 30% of the ground motion in the perpendicular, horizontal direction. The maximum displacement of the isolation system should be calculated as the vector sum of the two orthogonal displacements. The total maximum displacement of the isolators is the larger amongst these values accounting for inherent and accidental eccentricity and it generally occurs at corners.

Torsional effects should be considered as outlined in Section 5.3.2.

## 5.6.2 Modelling requirements

The mathematical models of the isolated structure including the isolation system, seismic force-resisting system and other structural elements should meet the following requirements.

### Isolation system

The isolation system should be modelled using deformational characteristics developed in accordance with Section 5.4. The lateral displacements and forces should be computed separately for upper-bound and lower-bound isolation system properties. Different models may be required for different limit states (SLS, ULS, CALS).

The isolation system should be modelled with sufficient detail to capture all of the following:

- spatial distribution of isolator devices, including any potential torsion effects in the isolation plane
- translation, in both horizontal directions, and torsion of the structure above the isolation interface considering the most disadvantageous location of mass eccentricity
- overturning/uplift forces on individual isolator devices
- effects of vertical load, bi-directional load, and/or the rate of loading if the force-deflection properties of the isolation system are dependent on one or more of these attributes.

The lateral displacement across the isolation system should be calculated using a model of the isolated structure with equivalent linear properties for the isolation system which incorporates the force-deflection characteristics of nonlinear elements of the isolation system and the seismic force-resisting system.

### Effective stiffness

The nonlinear isolator devices can be modelled as linear elastic elements with effective stiffness. The effective horizontal stiffness can be calculated using:

$$K_{eff} = \frac{|F_{max}| + |F_{min}|}{|\Delta_{max}| + |\Delta_{min}|} \quad (\text{Eq. 5-26})$$

where  $\Delta_{max}$  is the maximum positive horizontal displacement of the isolator unit during prototype testing,  $\Delta_{min}$  is the maximum negative horizontal displacement, and  $F_{max}$  and  $F_{min}$  are the horizontal forces corresponding to  $\Delta_{max}$  and  $\Delta_{min}$ , respectively. Refer to Figure 5-4 for a graphical depiction of this.

Maximum and minimum values of effective stiffness of the isolation system are used to calculate separately the maximum displacement of the isolation system (using minimum effective stiffness) and the maximum forces in the superstructure (using maximum effective stiffness).

The effective stiffness of nonlinear isolator devices modelled as linear elastic springs will need to be iterated, especially for lead rubber bearing types, as this is sensitive to the axial load demands on the bearings.

### Damping

MRSA shall be carried out using a modal damping value for the fundamental mode based on the effective damping of the isolation system, but no greater than 30% of critical damping. Modal damping values for higher modes shall be selected consistent with that of the superstructure assuming a fixed base condition. Therefore, the effective damping from the isolation system should only be applied at the first and isolated modes as illustrated in Figure 5-6.

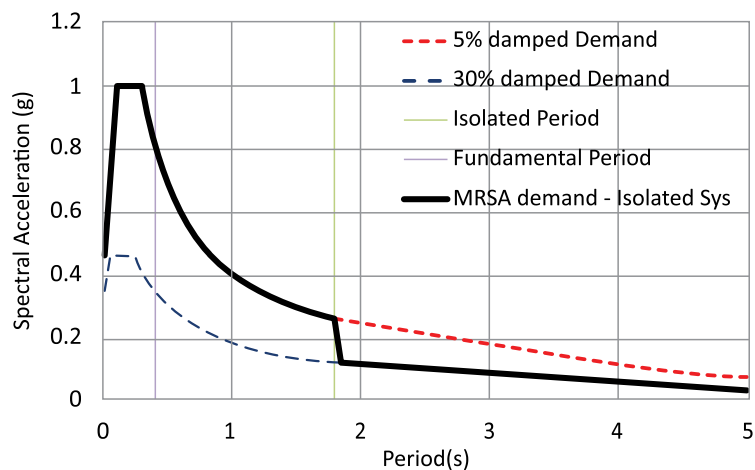

Figure 5-6: Application of damping to the isolated mode for MRSA analysis

## Superstructure

The maximum displacement of each floor and design forces and displacements in elements of the seismic force-resisting system are permitted to be calculated using a linear elastic model of the isolated structure, provided that all elements of the seismic force-resisting system of the structure above the isolation system remain essentially elastic.

Shear and moment amplification should be considered for superstructure responding in a limited or ductile manner.

## Uplift

Typically, isolator devices have little or no ability to resist tension forces and can uplift when earthquake overturning (upward) loads exceed gravity (downward) loads. Local uplift of individual elements is permitted, provided the resulting deflections do not cause overstress or instability of the isolated structure. To calculate uplift effects, gap elements may be used in nonlinear models or tension may be released manually in linear models (before re-running the MRSA).

## 5.7 Numerical integration time history analysis

### 5.7.1 General

Numerical integration time history analysis (NITHA), also known as response history analysis, is a specialised technique that captures the nonlinear dynamic responses of the superstructure and isolators under earthquake actions. It is considered the appropriate analysis method for complex and irregular isolated structures.

Nonlinear dynamic analyses can be performed through direct integration of the equation of motion or similar methods. The model of the structural system should be three-dimensional and include all components that significantly affect the seismic response of the building. All elements expected to respond in the nonlinear range in the design level earthquake (ULS) should be modelled with appropriate nonlinear models with design material properties.

NITHA should be carried out by engineers / analysts with suitable experience and expertise.

### 5.7.2 Modelling requirements

#### Modelling of isolators

The selected nonlinear hysteretic parameter should match as closely as possible to empirical data / evidence. The structural model used for the analyses as well as the representative force-displacement properties of the isolators adopted during preliminary design stages or ESA should represent all the following aspects:

- variations of the mechanical properties of the units including temperature, ageing, axial load and velocity of loading. Upper and lower bound parameters should be considered to take due account of these effects, unless these properties are determined from testing of the isolators
- axial stiffness of the devices under compression or tension forces.

## Modelling of superstructure

The superstructure should be modelled based on the design strength of the elements. Nonlinear responses of potential plastic hinge zones should be modelled based on appropriate material and elemental nonlinearity. Strain hardening is allowed.

### 5.7.3 Damping

In absence of any data, a critical viscous damping ratio of 5% as per Clause 6.4.6 of NZS 1170.5 should be adopted for the tangent isolated period.

The equivalent viscous damping in an NITHA is associated with the reduction in seismic response through energy dissipation other than those energy dissipation sources modelled explicitly by the nonlinear hysteresis of elements.

Nonlinear dynamic analyses are performed through direct integration of the motion equations, with adoption of a Rayleigh damping to model the damping non-hysteretic damping components. Rayleigh damping coefficients should be defined by assigning a damping coefficient not larger than 5% to the tangent isolated period (i.e. based on the tangent stiffness at the design displacement) and a damping coefficient not larger than 5% to the N-th translational period of the fixed base structure in each direction (where N is the number of building storeys above the isolation level, or the number of modes required to achieve 90% participating mass ratio for the fixed base building – whichever is greater).

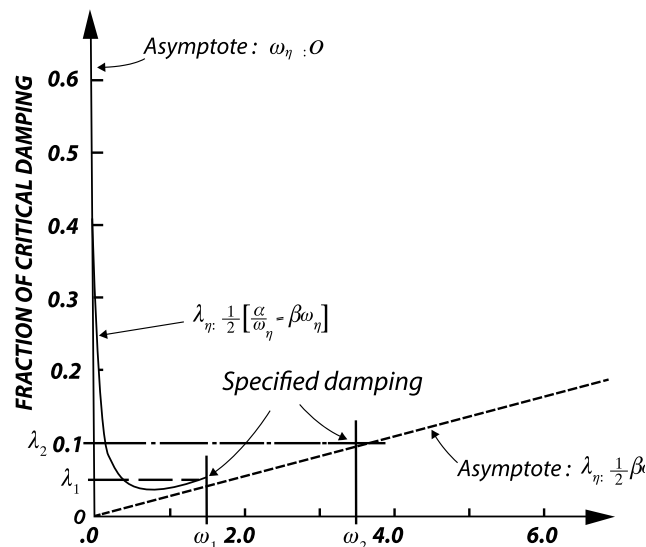

Figure 5-7: Rayleigh or proportional damping model

Supplementary energy dissipation devices (e.g. viscous, hysteretic or friction dampers) should be modelled explicitly in the nonlinear model.

### 5.7.4 Input ground motions

The criteria for selection, scaling and application of earthquake records for NITHA are defined in Chapter 4. Torsional effects should be considered as outlined in Section 5.3.2.

Vertical ground motion should be considered in the NITHA if the structure has any element or component that is sensitive to the amplification of axial and gravity loadings. These include the following scenarios:

- bearing uplift or near uplift in ULS level demand
- vertical discontinuity (transfer structure)
- cantilevered transfer structure
- long span structure
- non-structural elements that are sensitive to vertical accelerations.

### 5.7.5 Verification, peer review and documentation

Where a NITHA method is used this should be reviewed by a suitably experienced engineer as part of the peer review process. The review scope should include input parameters, modelling assumptions, input ground motions and the results of the NITHA.

## 5.8 Analysis of part of a building, and floor response spectra.

Parts of an isolated structure, permanent non-structural components and the attachments to them, and the attachments for permanent equipment supported by a structure should be analysed and designed to resist seismic forces and displacements based on the 'parts and components' loading of NZS 1170.5 Section 8 with the site hazard coefficient  $C(0)$  modified to equate the peak design acceleration of the base slab just above the isolators for the required limit state (typically SLS and ULS will be required as a minimum).

The design response coefficient for parts of NZS 1170.5 Clause 8.2 is:

$$C_p(T_p) = C(0)C_{Hi}C_i(T_p) \quad (\text{Eq. 5-27})$$

where:

$C(0)$  = Modified site hazard coefficient just above the isolation plane

$C_{Hi}$  = the floor height coefficient for level  $i$  (as determined by NZS 1170.5)

$T_p$  = the period of the part

$C_i(T_p)$  = the part spectral shape factor at level  $i$  (as determined by NZS 1170.5)

In addition, the design shall consider the level of excitation just before the seismic isolation system is activated; e.g. the peak acceleration corresponding to the 'yield' of the seismic isolation system. In this scenario the building may respond in a fixed-base condition and the parts loading shall be the same as that in NZS 1170.5 Section 8. For this reason, the ratio of the parts coefficient between SLS and ULS for an isolated building may not be the same as that for a fixed-based building (which is only a function of the return period of the seismic loading).

The model of the isolated structure can be used to generate acceleration and displacement spectra for each floor. This is in lieu of Section 8: Parts loading in NZS 1170.5. However, the inherent difficulties in establishing an accurate, yet realistic, estimate of the floor acceleration demand does not allow for general recommendations to be set at this stage. The use of floor response spectra from analysis should be subject to peer review.

# COMMENTARY

Section	Commentary
<p><b>5.2</b></p>	<p><b>Selecting the analysis method</b></p> <p>For some design scenarios, a mixture of analysis methods may be more appropriate; e.g. linear analyses for preliminary or developed design, and numerical integration time history for the final detailed design verification. SDOF analysis is a useful baseline verification for the other analysis methods in terms of the global responses such as base shear, isolated plane displacements etc.</p> <p>When dynamic analysis methods are used (MRSA, NITHA), the model is expected to include the modelling of the superstructure, isolators and substructure with the analysis output used to design the superstructure and substructure.</p> <p>Simplified models and analyses (e.g. SDOF analysis) are useful at the preliminary design phase. However, for Types 2, 3 and 4 a full 3D model is likely to be required to provide design verification of structural actions. The selection of analysis method, assumptions and criteria should be reviewed by the peer reviewer.</p> <p>The design forces for the isolation system, the substructure underneath and the superstructure should recognise the possibility for multiple scenarios to occur, as required to meet the design criteria and performance objectives as specified in Chapter 6. From an analysis point of view, this means undertaking a number of analyses to bound the displacement and internal actions for design, including consideration of scenarios such as:</p> <ul style="list-style-type: none"> <li>• a fixed-based building dynamic response prior to the yield of the isolation system, based on the upper bound properties of the isolation system</li> <li>• a fixed-based building static under the SLS design wind and SLS earthquake design actions.</li> </ul> <p>The analysis should be performed for a minimum shear force at the base of the superstructure equal to the ULS design wind load. This should not generally cause the yield of the isolation system. For the high rise isolated building, the isolation system may yield at the ULS design wind load and in such case, NITHA should be used. Literature such as the JSSI (2018) guidelines for wind-resistant design of base-isolated buildings should be referred to.</p>
<p><b>5.3</b></p> <p><b>5.3.1</b></p>	<p><b>General requirements</b></p> <p><b>Isolation system properties</b></p> <p>For ESA and MRSA, the superstructure should be modelled and checked using nominal capacities as per the relevant material standards. For NITHA the superstructure should be modelled and checked using probable capacities (i.e. with strength reduction factor <math>\phi</math> equal to 1.0), including allowance for strain hardening of ductility mechanisms and non-linear properties.</p>
<p><b>5.3.2</b></p>	<p><b>Mass eccentricity and torsion effects</b></p> <p>The effects of accidental eccentricity are permitted to be accounted for by amplifying forces, drifts and deformations determined from an analysis using only the computed centre-of-mass, provided that factors used to amplify forces, drifts and deformations of the centre-of-mass analysis are shown to produce results that bound all the mass-eccentric cases. The use of +/- 5% applied eccentricity is a departure from NZS 1170.5 which requires +/- 10%. This is considered appropriate for buildings designed to <math>S_p=1.0</math>, and designed to remain largely elastic even in a large earthquake.</p>
<p><b>5.3.4</b></p>	<p><b>Soil-structure interaction</b></p> <p>Buildings on base isolation systems can be sensitive to flexible foundation and soil, and soil flexibility can influence the response and load distribution within the building.</p> <p>For MRSA, the linear load-deformation characteristics of soil-foundation can be represented by an equivalent linear stiffness using soil properties that are compatible with the expected soil strain level at the design earthquake (ULS). A sensitivity analysis of the equivalent linear stiffness (twice and half the stiffness) should be carried out to determine the effects of the foundation flexibility to the overall response. The largest values of response should be used in design.</p> <p>For NITHA, the nonlinear load-deformation characteristics of soil-foundation can be modelled using appropriate nonlinear hysteretic models.</p>

Section	Commentary
<p><b>5.4</b></p>	<p><b>Single degree of freedom analysis</b></p> <p>The SDOF analysis is to be used for design of the isolation system, without further verification, only when all the requirements for an ESA are satisfied. In all the other scenarios, the SDOF analysis represents a preliminary design tool only, and the outcomes of this analysis (i.e. isolators' displacements, base shear, resulting storey forces) should be verified through the appropriate analysis method, MRSA or NITHA, as required.</p> <p>SDOF analysis represents the initial step of the design process. It is primarily useful for providing the size and properties of the isolation system, together with the imposed demands. The global isolation system-superstructure response is set to be equivalent to that of a single mass-stiffness system, with so-called 'equivalent' stiffness, mass and damping properties.</p> <p>The SDOF method assumes that the deformation of the superstructure is negligible when compared with the displacements imposed at the isolation level, and therefore the superstructure can be considered as a rigid body firmly anchored onto the slab/top of the isolation system. Based on this assumption, the total 'equivalent' displacement and damping of the combined isolators-superstructure system equate to those of the isolation system itself. The mass of the equivalent system should include the mass/weight of all components above the isolation plane including the floor level immediately above the isolators.</p> <p>The design performance of the system is determined through an acceleration-displacement response (ADRS) curve, as the intersection point between the system capacity curve and the demand. Therefore, an iterative process is required to ensure consistency is obtained between stiffness/damping assumed and actual demand.</p> <p>The ADRS analysis outcomes are the strength and stiffness properties of the isolation system together with the imposed displacement demand (and consequently base shear) for the selected earthquake intensity level.</p>
<p><b>5.4.1</b></p>	<p><b>SDOF ADRS analysis method</b></p> <p><b>SDOF analysis method: Step 1</b></p> <p>An initial starting design for the isolator system requires significant experience and engineering judgment. Typically, the isolator layout will be governed by the superstructure column grid and the type of isolator can be informed by the expected level of axial load on the isolators, the available geometrical space, and the expected level of lateral deformation.</p> <p><b>SDOF analysis method: Step 3</b></p> <p>The displacement corresponding to the corner period of the spectral displacement demand is a good starting point.</p> <p>It may be necessary to modify the design of the seismic isolation system in order to achieve convergence. This will be true if the initial design from Step 1 has insufficient strength or displacement capacity.</p> <p>For the building seismic weight, it is recommended that a reduced live load as per NZS 1170.5 is used. Typically, this is approximately 25% of the ULS live loading,</p> <p><b>SDOF analysis method: Step 4</b></p> <p>To ensure consistency between displacements and base shear in a displacement-based design environment, the acceleration ordinates as well as the displacement ordinates are required. The design ADRS spectra should be multiplied by the scaling factor <math>(1+S_p)/2</math>. This is equivalent to scaling the accelerations first by this factor and then calculating the corresponding displacements as <math>S_a^* \times T^2 / (4\pi^2)</math>, where <math>S_a^* = S_a \times (1+S_p)/2</math>.</p> <p><b>SDOF analysis method: Step 5b</b></p> <p>The isolation system for a seismically isolated structure should be configured to minimise eccentricity between the centre of mass of the superstructure and the centre of rigidity of the isolation system, thus reducing the effects of torsion on the displacement of isolation elements. Allowance must be made for accidental eccentricity in both horizontal directions.</p> <p>The additional component of displacement caused by torsion increases the design displacement at the corner of a structure by about 15% (for one perfectly square in plan) to about 30% (for one long and rectangular in plan) if the eccentricity is 5% of the maximum plan dimension.</p>



Section	Commentary
<p><b>5.4.1</b> <i>Continued</i></p>	<p>These calculated torsional displacements correspond to structures with an isolation system whose stiffness is uniformly distributed in plan. Isolation systems that have stiffness concentrated toward the perimeter of the structure, or certain sliding systems that minimise the effects of mass eccentricity, result in smaller torsional displacements. A torsional amplification factor as low as 1.15 can be used with proper justification.</p> <p><b>SDOF analysis method: Step 5c</b></p> <p>The base shear can be consequently obtained through the product of the effective stiffness times the COM displacement demand. Note that this represents the value transferred to the substructure. The base shear for the superstructure design should be obtained by removing the acceleration components directly acting on the isolation plane, by calculating the reduced base shear, <math>V_s</math> as specified in Section 5.5.2.</p>
<p><b>5.5</b></p> <p><b>5.5.1</b></p>	<p><b>Equivalent static analysis</b></p> <p><b>ESA General requirements</b></p> <p>ESA is a useful tool for preliminary analysis and design of the superstructure, using the reduced seismic coefficient as calculated from the SDOF analysis. However, a uniform rectangular vertical load distribution should be used to reflect the first mode of the building being an essentially rigid lateral translation of the building across the isolator plane. If the superstructure is relatively stiff, the equivalent static analysis is likely to result in a conservative approximation of the internal actions for preliminary design.</p>
<p><b>5.5.2</b></p>	<p><b>ESA Modelling requirements</b></p> <p>The isolation system for a seismically isolated structure should be configured to minimise eccentricity between the centre of mass of the superstructure and the centre of rigidity of the isolation system, thus reducing the effects of torsion on the displacement of isolation elements. For conventional structures, allowance must be made for accidental eccentricity in both horizontal directions.</p> <p>The additional component of displacement caused by torsion increases the design displacement at the corner of a structure by about 15% (for one perfectly square in plan) to about 30% (for one long and rectangular in plan) if the eccentricity is 5% of the maximum plan dimension.</p> <p>These calculated torsional displacements correspond to structures with an isolation system whose stiffness is uniformly distributed in plan. Isolation systems that have stiffness concentrated toward the perimeter of the structure, or certain sliding systems that minimise the effects of mass eccentricity, result in smaller torsional displacements. Torsional amplification factor as low as 1.15 can be used with proper justification.</p> <p><math>V_s</math> is the design base shear above the isolation plane, defined by reducing the design total base shear by the force acting on the base level just above the isolation plane (York and Ryan, 2004).</p>
<p><b>5.6</b></p> <p><b>5.6.1</b></p>	<p><b>Modal response spectrum analysis</b></p> <p><b>MRSA General requirements</b></p> <p>The approach of using the built-in methodology in software packages (e.g. ETABS), with damping coefficients directly applied to the single modes or to the isolators' springs should generally be avoided or used with caution. If software built-in methods are used, the engineer should provide evidence that the outcomes in terms of peak isolator displacement and peak building floor accelerations are within <math>\pm 10\%</math> the respective values obtained by using the MRSA damped spectrum.</p>
<p><b>5.6.2</b></p>	<p><b>MRSA Modelling requirements</b></p> <p>It is important that the fundamental period of the building from the analysis model is similar and consistent with the SDOF seismic isolation system's effective period. The fundamental period of the superstructure is highly dependent on the effective spring stiffness of the isolators. In turn, this may be dependent on the vertical load carried in those isolators. Therefore, every individual isolator must be modelled with the correct individual spring stiffness proportional to the seismic weight that it carries, if necessary. Therefore, it is anticipated some level of iteration of the MRSA models will be required.</p>

Section	Commentary
<p><b>5.7</b></p> <p><b>5.7.1</b></p>	<p><b>Numerical integration time history analysis</b></p> <p><b>NITHA General</b></p> <p>It is important to recognise that any output of a nonlinear time history analysis is only a snapshot representation of the building response to one particular earthquake record, so is highly dependent on the ability to adequately model the nonlinear element behaviour (NIST, 2011). Therefore, it is important to complete sensitivity and parametric analyses to gain an understanding of the seismic response of the building. Any advanced analysis requires significant effort and engineering judgement to ensure the validity of the outputs.</p> <p>A number of guidance documents have been published on NITHA for performance based seismic design and assessment (e.g. Deierlein et al., 2010; ASCE 41-13, 2013, FEMA 440). There are also a number of software programs for NITHA that are now commercially available (e.g. Ruaumoko, Seismosoft; Opensees, CSI products, ANSYS, and LS-DYNA).</p> <p>The maximum modal damping value at isolated and non-isolated periods for the fast numerical analysis (FNA) method should be limited to 2% equivalent viscous damping.</p>
<p><b>5.7.3</b></p>	<p><b>NITHA Damping</b></p> <p>It is recognised that Rayleigh damping has a number of issues and can lead to overdamping and unconservative results (Carr and Puthanpurayil (2018). It is recommended that a tangent or secant stiffness (only) proportional model (i.e. based on the isolation system stiffness after yield, at the design displacement level) is adopted for modelling inherent equivalent viscous damping in direct-integration analyses. Further information on damping is available in literature (e.g. Carr, 2007; Deierlein et al., 2010).</p> <p>A maximum damping coefficient of 2-3% is more common in other international guidelines for seismic isolated buildings (ASCE 41-16). ASCE 41-16 also provides different damping values for different systems. Research (e.g. Giammona, 2013) has shown that it can be unconservative to adopt Rayleigh damping at first and third modes (based on elastic stiffness), in particular for stiff and tall superstructures. Damping effect is also highly dependent on the analysis package.</p>
<p><b>5.7.4</b></p>	<p><b>Input ground motions</b></p> <p>Base isolated structures located near certain fault characteristics that produce large vertical accelerations are also more vulnerable and therefore may also require consideration of vertical ground motion excitation.</p> <p>Vertical ground acceleration may affect the behaviour of axial load-dependent isolation systems in the horizontal direction due to potential coupling between horizontal and vertical response of the building structure. Ryan and Dao (2016), Warn and Whittaker (2006) and Huang et al. (2009) discuss the effects of vertical acceleration on the response of seismically isolated structures.</p> <p>If it is elected to investigate the effect of vertical ground motion acceleration on building response, one of the following analysis methods is suggested:</p> <ul style="list-style-type: none"> <li>• Response spectrum analysis using horizontal and vertical spectrum (upwards and downwards).</li> <li>• Response spectrum analysis using a vertical spectrum, combined with horizontal response spectrum analysis results using orthogonal combinations corresponding to the 100%-30%-30% rule.</li> <li>• Three-dimensional response history analysis following the recommendations of Section 5.7 with explicit inclusion of vertical ground motion acceleration records.</li> <li>• Horizontal response history analysis following the provisions of Section 5.7 considering the two limiting initial gravity load conditions As recommended in ASCE-7-16, Clause 17.2.7.1. Note that this affects the effective characteristics of axial load-dependent isolators with resulting changes in base shear and displacement demands.</li> </ul> <p>The structural model in these analyses should be capable of capturing the effects of vertical response and vertical mass participation.</p>

Section	Commentary
5.8	<p><b>Analysis of part of a building, and floor response spectra.</b></p> <p><math>C(0)</math> should be taken as the design spectral coefficient obtained from the ADRS analysis based on upper bound isolation system properties, or from the envelope of the NITHA results when used. This value should not be lower than that required to satisfy the minimum base shear for superstructure design.</p> <p>There is empirical data from shaking table tests and NITHA studies indicating that the amplification of the lateral acceleration up the building height may not be as high as indicated by the <math>C_{hi}</math> factor used in NZS 1170.5. However, further studies are required before a more generalised recommendation can be made to depart from the NZS 1170.5 equation for the <math>C_{hi}</math> factor.</p> <p>Vertical acceleration can also impart a significant demand onto non-structural elements and parts of the structure. If the functionality of these non-structural elements is critical to the building design, the effects of vertical acceleration should be considered and analysed. The effect of nonlinear isolation systems on higher mode horizontal and vertical response largely affects floor acceleration outcomes, so computation of the initial (elastic) stiffness of the isolator devices must be made with care (Warn et al, 2007; Fenz and Constantinou, 2008; Huang et al., 2009).</p> <p>For all these reasons, floor spectra can be used for the design of parts only after careful review.</p>





**nzsee**  
NEW ZEALAND SOCIETY FOR  
EARTHQUAKE ENGINEERING

## 6. DESIGN

### CHAPTER CONTENT

### PAGE

6.1 The design process.....	78
6.2 Structural performance factor $S_p$ .....	78
6.3 Superstructure ductility .....	78
6.4 Capacity design of the superstructure .....	78
6.5 Bounding isolator property variability .....	79
6.6 Structural elements for isolator stability .....	79
6.7 Design criteria and procedures for each isolated building type .....	82
Commentary .....	93



MINISTRY OF BUSINESS,  
INNOVATION & EMPLOYMENT  
HIKINA WHAKATUTUKI

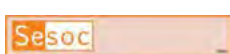

**NZCS** | New Zealand  
Concrete Society



**Quake Centre**  
Delivering Industry Solutions

## 6.1 The design process

Designers of isolated building systems and components should first determine the applicable isolated building type (as defined in Section 2.2).

The flowchart in Section 6.7 provides a checklist of isolation plane and superstructure characteristics to help identify the limitations for applicability to each type. This is followed by separate design reference tables for each (Table 6-1 to Table 6-4).

This guideline recommends reviewing the flowchart and associated reference tables before starting into the isolation design to understand what aspects may trigger a requirement to use a different design approach (e.g. that bearing tension or uplift requiring nonlinear time history should be carried out as performance verification).

In addition to the SLS, ULS and CALS limit states, base isolated structures need to be designed to fulfil any damage control performance objectives and criteria that have been agreed upon with the building owner (refer to Section 3.3).

## 6.2 Structural performance factor $S_p$

The structural performance factor  $S_p$  to be used for each isolated building type is given in Section 6.7. A different  $S_p$  may be selected for the isolation plane design and for the superstructure design, if appropriate.

## 6.3 Superstructure ductility

The superstructure design base-shear reduction factor that represents an allowance for ductility development in the superstructure should be in accordance with Table 2-2 and the flowchart in Section 6.7.

When considering design for ductility in the superstructure, the extent to which inelastic action will align with client expectations about damage control and reparability should be considered.

The introduction of assumed ductile behaviour to the superstructure design is limited to structures being designed and verified following the Type 3 methodology, described below. This approach requires nonlinear time history analysis (NITHA) modelling that incorporates inelastic behaviour not only of the isolators but also the superstructure. As discussed in Chapter 5, the superstructure should be modelled sufficiently to capture potential interaction and contributions from elements identified as primary lateral-force resisting elements and those typically assigned gravity load carrying roles during design. Simplification of the model to equivalent single-degree-of-freedom, or primary lateral-force resisting elements only, is unlikely to provide adequate information to fully evaluate the superstructure performance. Similarly, modelling the superstructure elastically is not sufficient for final performance evaluation.

Under the Type 3 methodology the performance of the building will be verified by the results of the NITHA, and this will require specific evaluation of local inelastic deformations to ensure that the target limit-state has not been exceeded. Because the performance of the building is being verified by the results of the NITHA, the assumption of a force-reduction factor for design is somewhat arbitrary, and the limits suggested here are intended to mitigate the potential for structures to be excessively sensitive to the potential interaction of the isolation and ductile superstructure.

It is recommended that a minimum detailing level should be for 'moderate ductility' for  $1.0 \leq k_\mu \leq 1.25$ . For  $1.25 < k_\mu \leq 2.0$  the detailing should correspond to 'fully ductile' requirements. It is also recommended that  $k_\mu$  does not exceed 3.0 at CALS demands. Designers should be very cautious about reducing the superstructure design base-shear by such levels, as the performance of the building can become unpredictable and very sensitive to ground motion characteristics.

## 6.4 Capacity design of the superstructure

Generally, the application of capacity design should follow with the design standard being used, and the clear definition of an inelastic mechanism should be maintained as would be the case for a 'fixed-base' building.

## 6.5 Bounding isolator property variability

Design should consider the variability of isolator properties. This should include the effects of:

- ageing and environmental effects
- heating, rate of loading and scragging
- manufacturing variations.

This variability should be accounted for during the initial isolation design phase, and if further analysis is being used to verify the isolation and superstructure performance (as in the Type 3 and 4 approaches). Table 6-5 (in the commentary for this chapter) provides values recommended by ASCE 7-16, Chapter 17 for lower bound, nominal, or upper bounds to be used in design or performance verification.

Significant experience with isolation design and behaviour would be required to adequately evaluate the above effects that contribute to variability, if done without guidance. The commentary to this chapter includes some discussion of key references from Europe and North America on this topic.

The issue of manufacturing variability is also referenced in Chapter 8 as part of the specification and procurement guidance. Allowing for manufacturing variability is an important aspect of the design, verification and specification process and can be considered in two aspects. The first is applicable to individual bearing units, and will generally relate to acceptable variation from nominal target behaviour. The second is the acceptable variation over the full population of bearings for the building, i.e. the isolation system variation. ‘Quality’ manufacturers (as discussed in the commentary to this chapter) will generally be able to achieve very close tolerances to the nominal bearing design over the full production run, even if individual units show more variation within the acceptable limits. This should be a key consideration for the design engineer as it affects the design and verification of the isolation system, and specification of the bearings themselves.

## 6.6 Structural elements for isolator stability

The structural element above and below the isolators and the connections of the isolator units to the structure shall be designed to resist all of the force and displacement actions required to maintain the stability of the isolators.

Design actions for structural elements above and below the isolators should properly account for forces in the isolators and additional equilibrium forces resulting from isolator displacement (P-delta) effects.

Derivation of forces above and below the isolation plane requires careful analysis for the correct support of the isolators. Forces derived from overall structural modelling should be rigorously checked against the simplifications shown in the following figures to ensure sufficient capacity is provided to retain equilibrium at the isolators at the displacements also shown below.

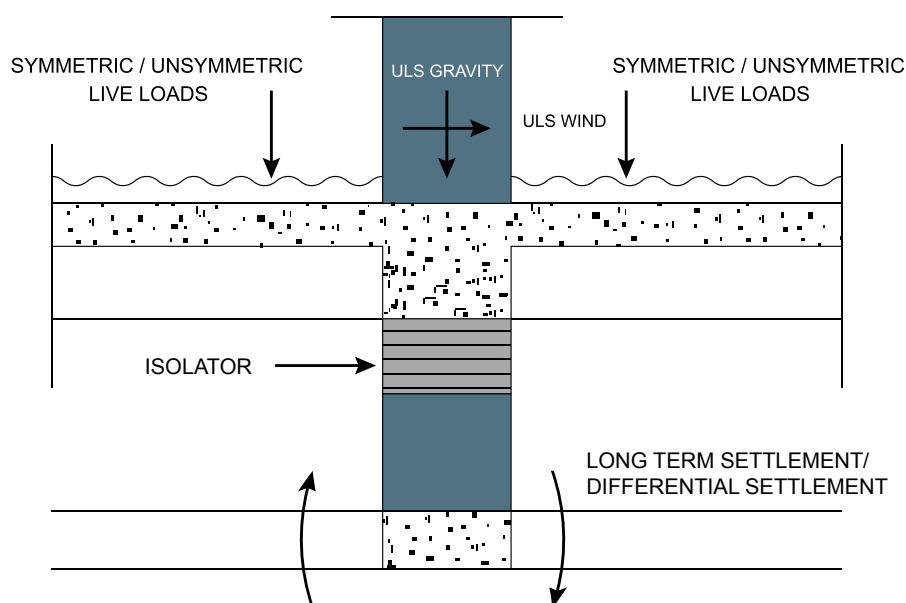

*Figure 6-1: Case 1 - ULS non-seismic loads, no seismic deflection*

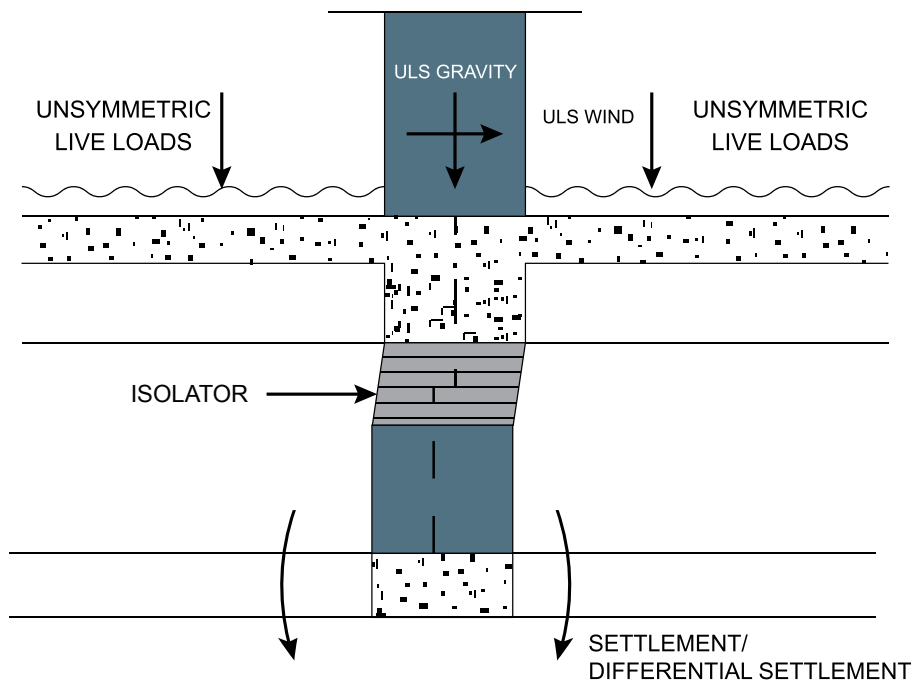

Figure 6-2: Case 2 - ULS vertical loads, residual deflections

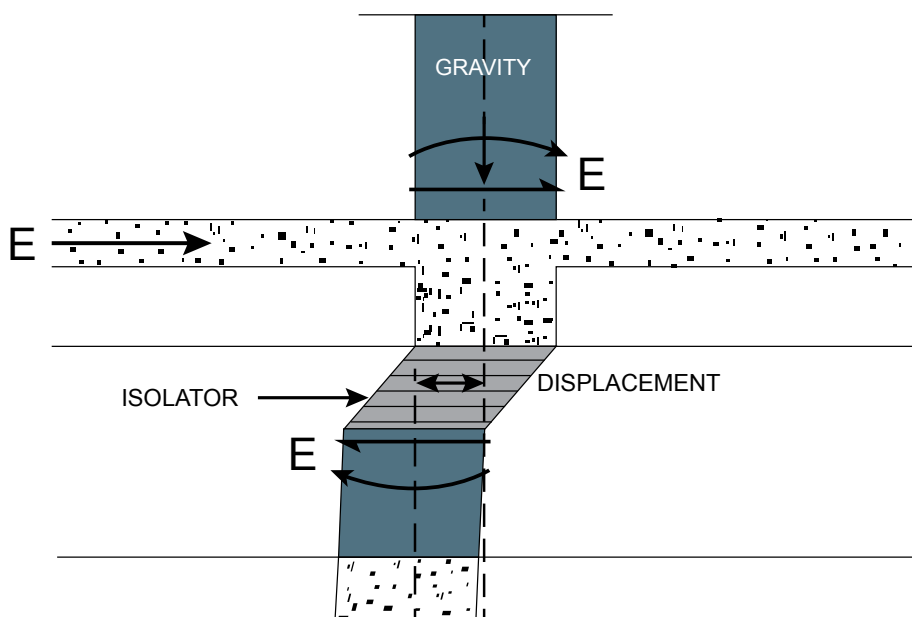

Figure 6-3: Case 3 - Design earthquake deflections and actions on the isolator and adjacent structural stability elements (for ULS and CLS limit states)

Correspondingly, it is important when building the structural model that the centrelines, element dimensions, storey heights and any rigid offsets are understood. Similarly, for the isolator elements themselves the shear centre/point of contraflexure and the distribution of P-delta forces should be accurately reflected. This is shown in the following figures which illustrate three isolator types.



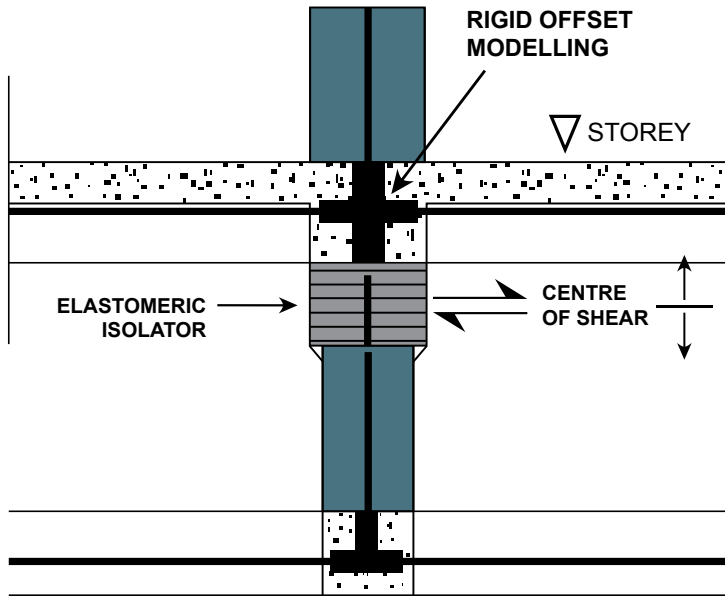

Figure 6-4: Geometrical modelling of elastomeric isolator

**P - delta**  
Split equally above and below isolator

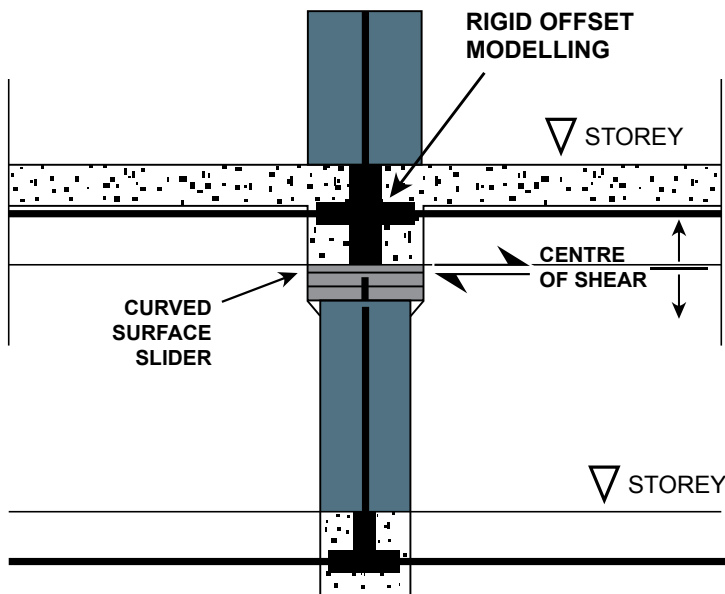

Figure 6-5: Geometrical modelling of curved surface slider isolator

**P - delta**  
Split equally above and below isolator

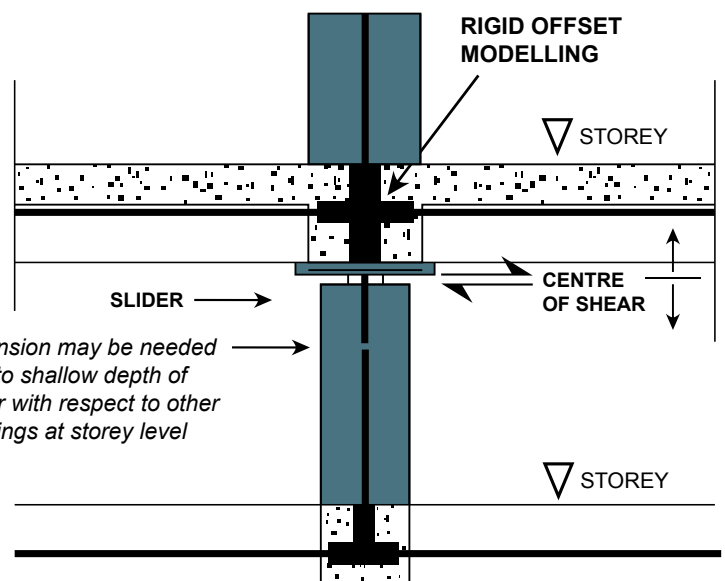

Figure 6-6: Geometrical modelling of flat slider isolator

**P - delta**  
To structure with sliding surface (100% upwards in this case)

Extension may be needed due to shallow depth of slider with respect to other bearings at storey level

## 6.7 Design criteria and procedures for each isolated building type

The isolation plane superstructure and substructure parts of the building should be designed in accordance with NZS 1170 and relevant materials codes based on the design procedures, parameters and criteria in the following sections.

### 6.7.1 Isolation plane design flowchart

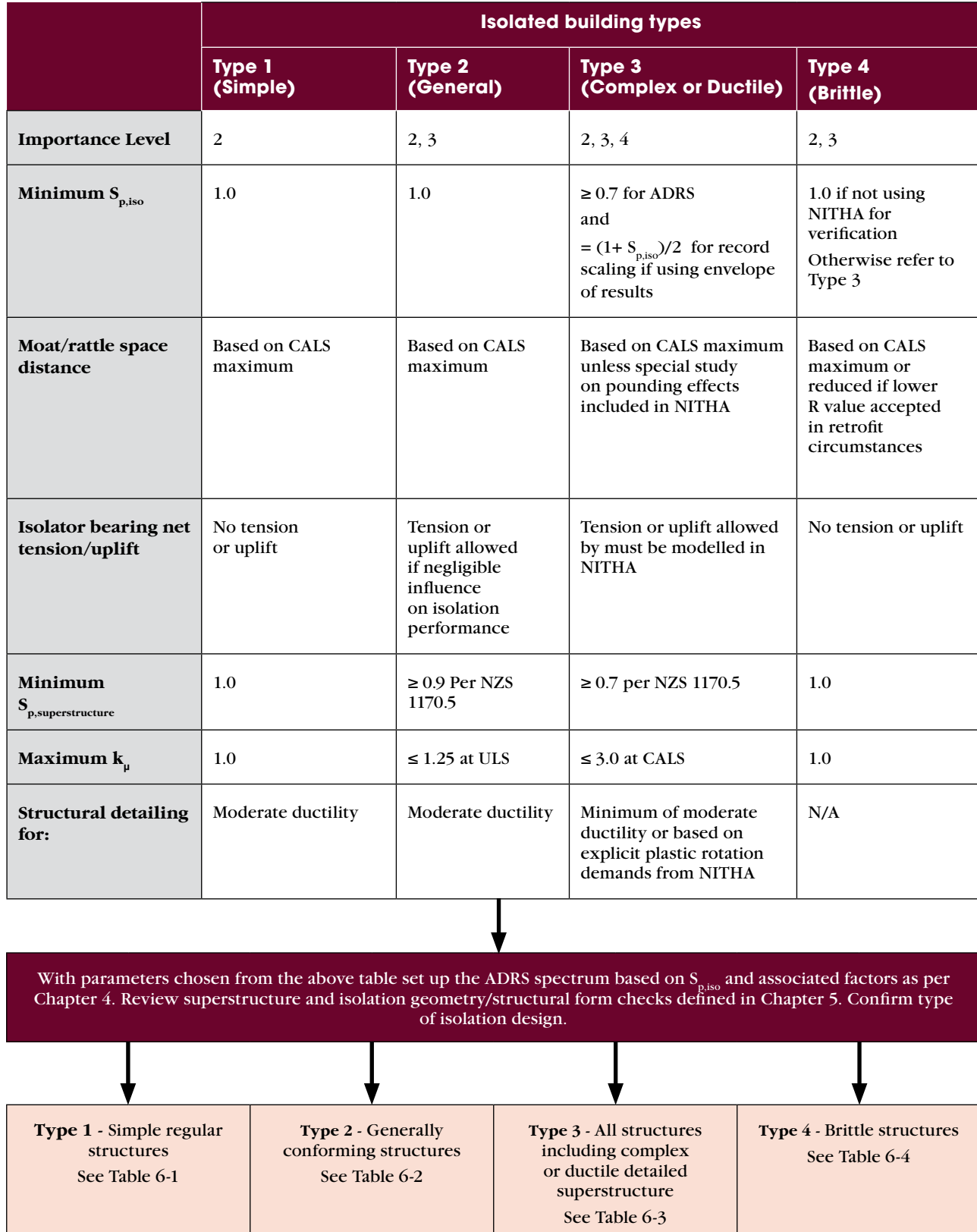

Figure 6-7: Isolation plane design flowchart

## 6.7.2 Isolated building Type 1: Simple

**Table 6-1: Design procedure for Type 1 isolated buildings**

Step	Procedure	Reference and specific information for design checks									
<b>Isolation plane design</b>											
I-1-1	The general isolation design procedure is applicable for structures satisfying Table 2-1.	Table 2-1									
I-1-2	Confirm if superstructure and isolation plane geometry/structural form checks for regularity criteria allow design using an equivalent static approach. If not a modal or time history analysis is required with review against relevant criteria.	Analysis: Section 5.2									
I-1-3	Estimate fixed-base period of superstructure using typical methods of elastic fixed-base period estimation.	—									
I-1-4	Setup ULS + CALS isolation plane design spectrum.	Hazard: Chapter 4									
I-1-5	Use a displacement-based/ADRS plot approach to designing the isolation plane characteristics with checks made at the isolation plane centre-of-mass and critical corner.	<p>Confirm that isolation and superstructure characteristics still meet simplified design criteria.</p> <p>Review effective stiffness and reliable restoring force of system based on nominal isolator properties. Must satisfy limits below per ASCE 7-16.</p> <table border="1"> <thead> <tr> <th></th> <th>LRB</th> <th>Curved sliding surface</th> </tr> </thead> <tbody> <tr> <td>Limiting change in <math>T_{eff}</math> ASCE 7-16: 17.4.1.7a</td> <td><math>Q_d &lt; K_d \Delta</math></td> <td><math>R &lt; \frac{\Delta}{\mu}</math></td> </tr> <tr> <td>Reliable restoring stiffness ASCE 7-16: 17.2.4.4</td> <td><math>K_d &gt; \frac{0.05W}{\Delta}</math></td> <td><math>R &lt; 20\Delta</math></td> </tr> </tbody> </table>		LRB	Curved sliding surface	Limiting change in $T_{eff}$ ASCE 7-16: 17.4.1.7a	$Q_d < K_d \Delta$	$R < \frac{\Delta}{\mu}$	Reliable restoring stiffness ASCE 7-16: 17.2.4.4	$K_d > \frac{0.05W}{\Delta}$	$R < 20\Delta$
	LRB	Curved sliding surface									
Limiting change in $T_{eff}$ ASCE 7-16: 17.4.1.7a	$Q_d < K_d \Delta$	$R < \frac{\Delta}{\mu}$									
Reliable restoring stiffness ASCE 7-16: 17.2.4.4	$K_d > \frac{0.05W}{\Delta}$	$R < 20\Delta$									
I-1-6	Is the design to result in a <i>Target Isolation Performance</i> or a full <i>Bearing Specification</i> ?	<p>If a <i>Target Isolation Performance</i> specification then no further iteration on the isolation plane design is needed.</p> <p><b><i>Bearing Specification</i></b></p> <p>Include checks on the isolator characteristics, i.e. the actual design of the isolator unit itself for strain limits, bearing overlaps or friction interface limits. The above preliminary isolation plane data can then be used to establish actions from the superstructure that are used in turn to iterate on the isolation plane design.</p> <ul style="list-style-type: none"> <li>• In particular, the axial loads coming from the superstructure onto the isolator devices are needed.</li> <li>• The axial loads will be a function of superstructure design ductility.</li> </ul>									
I-1-7	If isolation plane design is settled the final values of $Q_d$ and $K_{eff}$ can be used to set up the superstructure design.	If ULS net tension or uplift due to lateral response occurs at any of the isolator/bearing locations then an equivalent static analysis is not appropriate for design. A Type 2 or 3 approach is required.									

**Table 6-1: Design procedure for Type 1 isolated buildings (Continued)**

Step	Procedure	Reference and specific information for design checks
<b>Superstructure ULS design</b>		
S-1-1	The superstructure design base shear is determined from the isolation system yield characteristics, with checks for wind load as per normal structural design.	—
S-1-2	From isolation system design the following information is available: <ul style="list-style-type: none"> <li>the isolation plane yield force: <math>Q_d</math></li> <li>effective period of the isolation system at ULS: <math>T_{eff, ULS}</math></li> <li>elastic 5% damping spectral definition as either NZS 1170.5 or site specific spectra: Z, R, N, <math>C_h</math>.</li> </ul>	—
S-1-3	Determine minimum design base shear for superstructure from the maximum of: <ul style="list-style-type: none"> <li><math>1.5 \times Q_{d,nom,elastomeric}</math> or <math>1.5 \times Q_{d,UB,friction}</math></li> <li><math>[V_{s,ULS}]/k_\mu</math></li> <li>wind ULS base shear force.</li> </ul>	$k_\mu = 1.0$ $S_{p,superstructure} = 1.0$ $\phi$ as per NZS material design standards
S-1-4	Superstructure base shear can then be distributed vertically as equivalent lateral forces.	See Section 5.5 for ESA force distribution method.
S-1-5	Resulting structural actions can then be used for member design per material design Standards.	—
S-1-6	Once the design axial loads on the columns/wall ends are defined these should be checked against those previously used for the isolation plane and isolator unit design. If values are significantly different then iterate the isolation design. <ul style="list-style-type: none"> <li>To specify a valid design, it is recommended that minimum overlaps, shear strains and bearing pressures are reviewed at this point to mitigate the need for subsequent changes once a supplier is involved.</li> </ul>	Review net tension on isolators due to lateral response. <ul style="list-style-type: none"> <li>ULS: No net tension or uplift is allowed for in the simplified design approach. Verification using nonlinear time history is required if this is not satisfied.</li> <li>CALS: Tensile stress less than 2G on elastomeric bearings. Uplift on sliding surface bearings is acceptable but design bearing pressures should be set to provide a margin for impact related pressure peaks.</li> </ul>
<b>Superstructure CALS review</b>		
S-1-7	Typically, the superstructure does not have a specific CALS design. However, the actions of the superstructure under CALS demands are required to confirm the performance expectation, e.g., damage criteria and stability of the isolator units under peak displacement. <ul style="list-style-type: none"> <li>This requires axial loads on the isolators.</li> <li>Isolator CALS displacements are based on lower bound isolator properties.</li> </ul>	—
S-1-8	Maximum CALS isolation displacements are used to confirm the movement allowances of various aspects of the structure to provide adequate clearance: <ul style="list-style-type: none"> <li>moat/rattle space</li> <li>access and exit ways including stairs and lift shafts</li> <li>items such as cladding panels where contact due to isolation plane movement could result in a localised falling object hazard.</li> </ul>	—
<b>Substructure review</b>		
S-1-8	Substructure capacity design demands are based on upper bound ULS analysis forces and lower bound ULS analysis displacements of the isolation plane $k_\mu = 1.0$	—

### 6.7.3 Isolated building Type 2: General

**Table 6-2: Design procedure for Type 2 isolated buildings**

Step	Procedure	Reference and specific information for design checks									
<b>Isolation plane design</b>											
I-2-1	The general isolation design procedure is applicable for structures satisfying Table 2-1.	Table 2-1									
I-2-2	Isolation plane design performance checks to confirm that a modal analysis is applicable. If not, then nonlinear time history analysis is required.	Analysis: Section 5.2									
I-2-3	Estimate fixed-base period of superstructure using <ul style="list-style-type: none"> <li>modal analysis of linear-elastic computer model in 3D.</li> </ul>	—									
I-2-4	Setup ULS + CALS isolation plane design spectrum.	Hazard: Chapter 4									
I-2-5	Use a displacement-based/ADRS plot approach to designing the isolation plane characteristics: <ul style="list-style-type: none"> <li>checks made at the isolation plane centre-of-mass and critical corner.</li> </ul>	<p>Confirm that isolation and superstructure characteristics still meet simplified design criteria.</p> <p>Review effective stiffness and reliable restoring force of system based on nominal isolator properties. Must satisfy limits below per ASCE 7-16.</p> <table border="1"> <thead> <tr> <th></th> <th>LRB</th> <th>Curved sliding surface</th> </tr> </thead> <tbody> <tr> <td>Limiting change in <math>T_{eff}</math> ASCE 7-16: 17.4.1.7a</td> <td><math>Q_d &lt; K_d \Delta</math></td> <td><math>R &lt; \frac{\Delta}{\mu}</math></td> </tr> <tr> <td>Reliable restoring stiffness ASCE 7-16: 17.2.4.4</td> <td><math>K_d &gt; \frac{0.05W}{\Delta}</math></td> <td><math>R &lt; 20\Delta</math></td> </tr> </tbody> </table>		LRB	Curved sliding surface	Limiting change in $T_{eff}$ ASCE 7-16: 17.4.1.7a	$Q_d < K_d \Delta$	$R < \frac{\Delta}{\mu}$	Reliable restoring stiffness ASCE 7-16: 17.2.4.4	$K_d > \frac{0.05W}{\Delta}$	$R < 20\Delta$
	LRB	Curved sliding surface									
Limiting change in $T_{eff}$ ASCE 7-16: 17.4.1.7a	$Q_d < K_d \Delta$	$R < \frac{\Delta}{\mu}$									
Reliable restoring stiffness ASCE 7-16: 17.2.4.4	$K_d > \frac{0.05W}{\Delta}$	$R < 20\Delta$									
I-2-6	Is the design to result in a <i>Target Isolation Performance</i> or a full <i>Bearing Specification</i> ?	<p>If a <i>Target Isolation Performance</i> specification then no further iteration on the isolation plane design is needed.</p> <p><i>Bearing Specification</i></p> <p>Include checks on the isolator characteristics, i.e. the actual design of the isolator unit itself for strain limits, bearing overlaps or friction interface limits. The above preliminary isolation plane data can be used to establish actions from the superstructure that are used in turn to iterate on the isolation plane design.</p> <ul style="list-style-type: none"> <li>In particular, the axial loads coming from the superstructure onto the isolator devices are needed.</li> <li>The axial loads will be a function of superstructure design ductility.</li> </ul>									
I-2-7	If isolation plane design is settled the final values of $Q_d$ and $K_{eff}$ can be used set up the superstructure design.	If ULS net tension or uplift due to lateral response occurs, then review the significance on isolation performance to confirm if Type 3 analysis required.									
<b>Superstructure ULS design</b>											
S-2-1	The superstructure design base shear is determined from the isolation system yield characteristics, with checks for wind load as per normal structural frame design.	—									
S-2-2	From isolation system design the following information is available: <ul style="list-style-type: none"> <li>the isolation plane yield force: <math>Q_d</math></li> <li>effective period of the isolation system at ULS: <math>T_{eff,ULS}</math></li> <li>elastic 5% damping spectral definition as either NZS 1170.5 or site specific spectra: <math>Z, R, N, C_h</math>.</li> </ul>	—									

**Table 6-2: Design procedure for Type 2 isolated buildings (continued)**

Step	Procedure	Reference and specific information for design checks
<b>Superstructure ULS design (continued)</b>		
S-2-3	<p>Minimum design base shear for superstructure determined from the maximum of:</p> <ul style="list-style-type: none"> <li>• <math>1.5 \times Q_{d,nom,elastomeric}</math> or <math>1.5 \times Q_{d,UB,friction}</math></li> <li>• <math>[V_{s,ULS}]/k_{\mu}</math></li> <li>• wind ULS base shear force.</li> </ul>	$k_{\mu} \leq 1.25$ $S_{p,superstructure}$ = per NZS 1170.5 $\phi$ as per NZS material design standards
S-2-4	<p>Superstructure base shear can then be used by:</p> <ul style="list-style-type: none"> <li>• scaling the inputs to a modal analysis to match the minimum design base shear.</li> </ul>	See Section 5.6 for modal response spectrum analysis method
S-2-5	<p>Resulting structural actions can then be used for member design per material design Standards:</p> <ul style="list-style-type: none"> <li>• Following through the design with chosen <math>k_{\mu}</math> and <math>S_{p,superstructure}</math>.</li> </ul>	—
S-2-6	<p>Once the design axial loads on the columns/wall-ends are defined these should be checked against those previously used for the isolation plane and isolator unit design. If values are significantly different then iterate the isolation design.</p> <ul style="list-style-type: none"> <li>• To specify a valid design, it is recommended that minimum overlaps, shear strains and bearing pressures are reviewed at this point to mitigate the need for subsequent changes once a supplier is involved.</li> </ul>	<p>Review net tension on isolators:</p> <ul style="list-style-type: none"> <li>• ULS: Net tension or uplift is allowed due to lateral response if influence on isolation plane response is insignificant.</li> <li>• CALS: Tensile stress less than 2G on elastomeric bearings. Uplift on sliding surface bearings is acceptable but design bearing pressures should be set to provide a margin for impact related pressure peaks.</li> </ul>
<b>Superstructure CALS review</b>		
S-2-7	<p>Typically, the superstructure does not have a specific CALS design. However, the actions of the superstructure under CALS demands are required to confirm the performance expectation, e.g., damage criteria and stability of the isolator units under peak displacement.</p> <ul style="list-style-type: none"> <li>• This requires axial loads on the isolators.</li> <li>• Isolator CALS displacements are based on lower bound isolator properties.</li> </ul>	—
S-2-8	<p>Maximum CALS isolation displacements are used to confirm the movement allowances of various aspects of the structure to provide adequate clearance:</p> <ul style="list-style-type: none"> <li>• moat/rattle space</li> <li>• access and exit ways including stairs and lift shafts</li> <li>• Items such as cladding panels where contact due to isolation plane movement could result in a localised falling object hazard.</li> </ul>	—
<b>Substructure review</b>		
SS-2-1	<ul style="list-style-type: none"> <li>• Substructure capacity design demands are based on upper bound ULS analysis forces and lower bound ULS analysis displacements of the isolation plane.</li> <li>• <math>k_{\mu} = 1.0</math></li> </ul>	—

### 6.7.4 Isolated building Type 3: Complex or Ductile

**Table 6-3: Design procedure for Type 3 isolated buildings**

Step	Procedure	Reference and specific information for design checks						
<b>Isolation plane design</b>								
I-3-1	The general isolation design procedure is applicable for structures satisfying Table 2-1.	—						
I-3-2	Setup ULS + CALS isolation plane design spectrum.	—						
I-3-3	Use a displacement-based/ADRS plot approach to designing the isolation plane characteristics: <ul style="list-style-type: none"> <li>checks made at the isolation plane centre-of-mass and critical corner.</li> </ul>	<p>Review effective stiffness and reliable restoring force of system based on nominal isolator properties. Must satisfy limits below per ASCE 7-16.</p> <table border="1"> <thead> <tr> <th></th> <th>LRB</th> <th>Curved sliding surface</th> </tr> </thead> <tbody> <tr> <td>Reliable restoring stiffness ASCE 7-16: 17.2.4.4</td> <td><math>K_d &gt; \frac{0.05W}{\Delta}</math></td> <td><math>R &lt; 20\Delta</math></td> </tr> </tbody> </table>		LRB	Curved sliding surface	Reliable restoring stiffness ASCE 7-16: 17.2.4.4	$K_d > \frac{0.05W}{\Delta}$	$R < 20\Delta$
	LRB	Curved sliding surface						
Reliable restoring stiffness ASCE 7-16: 17.2.4.4	$K_d > \frac{0.05W}{\Delta}$	$R < 20\Delta$						
I-3-4	<p>Is the design to result in a <i>Target Isolation Performance</i> or a full <i>Bearing Specification</i>?</p> <p>Elastomeric bearings with CALS strain factors <math>\geq 1.2</math> can maintain their design based on <math>S_{p,iso}</math> as used to define the ADRS. Otherwise, their CALS shear displacement should be evaluated based on <math>S_{p,iso} = 1.0</math>.</p> <p>Sliding surface bearings should be evaluated for CALS displacement using <math>S_{p,iso} = 1.0</math>.</p>	<p>If a <i>Target Isolation Performance</i> specification, then no further iteration on the isolation plane design is needed</p> <p>For a <i>Bearing Specification</i> include checks on the isolator characteristics, i.e. the actual design of the isolator unit itself for strain limits, bearing overlaps or friction interface limits. The above preliminary isolation plane data can then be used to establish actions from the superstructure that are used in turn to iterate on the isolation plane design.</p> <ul style="list-style-type: none"> <li>In particular, the axial loads coming from the superstructure onto the isolator devices is needed.</li> <li>The axial loads will be a function of superstructure design ductility.</li> </ul>						
I-3-5	If isolation plane design is settled the final values of $Q_d$ and $K_{eff}$ can be used to set up the superstructure design.	If ULS net tension or uplift due to lateral response occurs, then review the significance on isolation performance to confirm if Type 3 analysis is required.						
I-3-6	<p>Due to potential complexity of the ductile response of superstructure and isolation interaction nonlinear time history analyses are necessary to validate the performance of both superstructure and isolation system.</p> <p>Record scaling is based on <math>S_p = (S_{p,iso} + 1)/2</math> when using the envelope of maximum results. If using a hybrid elastomeric/sliding surface isolation system then multiple verification runs may be required to accommodate the values of <math>S_{p,iso}</math> in Step I-3-4.</p>	Is using averaged results from 7 or more records $S_p = 1.0$ for record scaling						

**Table 6-3: Design procedure for Type 3 isolated buildings (continued)**

Step	Procedure	Reference and specific information for design checks
<b>Superstructure ULS design</b>		
S-3-1	The superstructure design base shear is determined from the isolation system yield characteristics, with checks for wind load as per normal structural frame design.	—
S-3-2	From isolation system design the following information is available: <ul style="list-style-type: none"> <li>the isolation plane yield force: <math>Q_d</math></li> <li>effective period of the isolation system at ULS: <math>T_{\text{eff,ULS}}</math></li> <li>elastic 5% damping spectral definition as either NZS 1170.5 or site specific spectra: <math>Z, R, N, C_h</math>.</li> </ul>	—
S-3-3	Minimum design base shear for superstructure determined from the maximum of: <ul style="list-style-type: none"> <li><math>1.5 \times Q_{d,\text{nom,elastomeric}}</math> or <math>1.5 \times Q_{d,\text{UB,friction}}</math></li> <li><math>[V_{s,\text{ULS}}]/k_\mu</math></li> <li>wind ULS base shear force.</li> </ul>	$k_\mu < 2.0$ $S_{p,\text{superstructure}} = \text{per NZS 1170.5}$ $\Phi$ as per NZS material design standards
S-3-4	Superstructure base shear can then be used by: <ul style="list-style-type: none"> <li>scaling the inputs to a modal analysis to match the minimum design base shear.</li> </ul>	See Section 5.6 for modal response spectrum analysis method
S-3-5	Resulting structural actions can then be used for member design per material design Standards: <ul style="list-style-type: none"> <li>following through the design with chosen <math>k_\mu</math> and <math>S_{p,\text{superstructure}}</math>.</li> </ul>	—
S-3-6	Once the design axial loads on the columns/wall-ends are defined these should be checked against those previously used for the isolation plane and isolator unit design. If values are significantly different then iterate the isolation design. <ul style="list-style-type: none"> <li>To specify a valid design, it is recommended that minimum overlaps, shear strains and bearing pressures are reviewed at this point to mitigate the need for subsequent changes once a supplier is involved.</li> </ul>	Review net tension on isolators: <ul style="list-style-type: none"> <li>ULS: Net tension and uplift are allowed if modelled appropriately to capture the behaviour of the elastomeric or sliding surface isolators.</li> <li>CALS: Tensile stress less than 2G on elastomeric bearings. Uplift on sliding surface isolators is acceptable but design bearing pressures should be set to provide a margin for impact related pressure peaks.</li> </ul>
<b>Superstructure CALS review</b>		
S-3-7	Typically, the superstructure does not have a specific CALS design. However, the actions of the superstructure under CALS demands are required to confirm the performance expectation, e.g., damage criteria and stability of the isolator units under peak displacement. <ul style="list-style-type: none"> <li>This requires axial loads on the isolators.</li> <li>Isolator CALS displacements are based on lower bound isolator properties.</li> </ul>	<ul style="list-style-type: none"> <li><math>k_\mu</math> permitted but is to be evaluated at CALS including P-delta and potential degrading stiffness effects to confirm that <math>k_\mu \leq 3</math>. This value is only provided to help designers recognise that superstructure capacity reductions must be closely controlled. Local plastic rotations will be explicitly evaluated from NITHA.</li> <li>CALS <math>\theta_{\text{max,superstructure}} \leq 2.5\%</math></li> <li><math>S_{p,\text{superstructure}} = \text{per NZS 1170.5}</math></li> <li><math>\Phi = 1.0</math></li> <li>Probable strengths for material properties</li> </ul>



**Table 6-3: Design procedure for Type 3 isolated buildings (continued)**

Step	Procedure	Reference and specific information for design checks																								
<b>Superstructure CALS review (continued)</b>																										
S-3-8	<p>Maximum CALS isolation displacements are used to confirm the movement allowances of various aspects of the structure to provide adequate clearance, including:</p> <ul style="list-style-type: none"> <li>• access and exit ways including stairs and lift shafts</li> <li>• items such as cladding panels where contact due to isolation plane movement could result in a localised falling object hazard</li> <li>• moat/rattle space to target CALS isolation maximum displacement. If this distance is not provided in the isolation plane design, then contact/gap elements must be explicitly modelled around the perimeter of the isolation plane. If contact below CALS displacements can occur, then floor acceleration spectra must be generated at sufficient locations across each floor plan to enable the designer to capture the acceleration spikes that could govern Parts design loads. Amplified shear forces from the analysis must also be allowed for in the design.</li> </ul> <p>Due to the potential complexity of ductile response of superstructure and isolation interaction nonlinear response history analyses are necessary to validate the performance of both the superstructure and isolation systems.</p>	<table border="1"> <thead> <tr> <th colspan="3" data-bbox="850 371 1423 468">Isolation plane life-safety related aspects</th> </tr> <tr> <th data-bbox="850 468 983 551"></th> <th data-bbox="983 468 1177 551">Capacity design not applied</th> <th data-bbox="1177 468 1423 551">Capacity design applied</th> </tr> </thead> <tbody> <tr> <td data-bbox="850 551 983 633">NITHA not used</td> <td data-bbox="983 551 1177 633"><math>S_{p,iso} = 1.0</math></td> <td data-bbox="1177 551 1423 633"><math>S_{p,iso} = 1.0</math></td> </tr> <tr> <td data-bbox="850 633 983 725">NITHA used</td> <td data-bbox="983 633 1177 725"><math>S_{p,iso} = 1.0</math></td> <td data-bbox="1177 633 1423 725"><math>S_{p,iso} = 1.0</math></td> </tr> <tr> <th colspan="3" data-bbox="850 725 1423 822">Isolation plane moat/rattle space</th> </tr> <tr> <th data-bbox="850 822 983 904"></th> <th data-bbox="983 822 1177 904">Capacity design not applied</th> <th data-bbox="1177 822 1423 904">Capacity design applied</th> </tr> <tr> <td data-bbox="850 904 983 987">NITHA not used</td> <td data-bbox="983 904 1177 987"><math>S_{p,iso} = 1.0</math></td> <td data-bbox="1177 904 1423 987"><math>S_{p,iso} = 1.0</math></td> </tr> <tr> <td data-bbox="850 987 983 1079">NITHA used</td> <td data-bbox="983 987 1177 1079"><math>S_{p,iso} = 1.0</math></td> <td data-bbox="1177 987 1423 1079"><math>S_{p,iso} = 1.0</math></td> </tr> </tbody> </table>	Isolation plane life-safety related aspects				Capacity design not applied	Capacity design applied	NITHA not used	$S_{p,iso} = 1.0$	$S_{p,iso} = 1.0$	NITHA used	$S_{p,iso} = 1.0$	$S_{p,iso} = 1.0$	Isolation plane moat/rattle space				Capacity design not applied	Capacity design applied	NITHA not used	$S_{p,iso} = 1.0$	$S_{p,iso} = 1.0$	NITHA used	$S_{p,iso} = 1.0$	$S_{p,iso} = 1.0$
Isolation plane life-safety related aspects																										
	Capacity design not applied	Capacity design applied																								
NITHA not used	$S_{p,iso} = 1.0$	$S_{p,iso} = 1.0$																								
NITHA used	$S_{p,iso} = 1.0$	$S_{p,iso} = 1.0$																								
Isolation plane moat/rattle space																										
	Capacity design not applied	Capacity design applied																								
NITHA not used	$S_{p,iso} = 1.0$	$S_{p,iso} = 1.0$																								
NITHA used	$S_{p,iso} = 1.0$	$S_{p,iso} = 1.0$																								
<b>Substructure review</b>																										
SS-3-1	<ul style="list-style-type: none"> <li>• Substructure capacity design demands are based on upper bound ULS analysis forces and lower bound ULS analysis displacements of the isolation plane.</li> <li>• <math>k_{\mu} = 1.0</math></li> <li>• If contact with moat can occur before CALS maximum displacement, then the effects of this on the substructure are to be reviewed for strength and stability using <math>\phi = 1.0</math> and material properties (use probable strengths).</li> </ul>	—																								

### 6.7.5 Isolated building Type 4: Brittle

**Table 6-4: Design procedure for Type 4 isolated buildings**

Step	Procedure	Reference and specific information for design checks									
<b>Isolation plane design</b>											
I-4-1	The general isolation design procedure is applicable for structures satisfying Table 2-1.	Table 2-1									
I-4-2	Confirm if superstructure and isolation plane geometry/structural form checks for regularity criteria allow design using an equivalent static approach. If not a modal or time history analysis is required with review against relevant criteria.	Analysis: Section 5.2									
I-4-3	Estimate fixed-base period of superstructure using: <ul style="list-style-type: none"> <li>typical methods of elastic fixed-base period estimation.</li> </ul>	—									
I-4-4	Set up CALS isolation plane design spectrum. <ul style="list-style-type: none"> <li>Adjust R if target &lt; 100% Code demand.</li> </ul> The choice of $S_p$ that can be used is a function of: <ul style="list-style-type: none"> <li>the level of analytical verification that will subsequently be carried out</li> <li><math>S_{p,iso}</math> applied to the displacement spectrum.</li> </ul>	<table border="1"> <tr> <td>NITHA not used</td> <td><math>S_{p,iso} = 1.0</math></td> </tr> <tr> <td>NITHA used Reference I-4-6</td> <td><math>S_{p,iso} = 0.7</math></td> </tr> </table>	NITHA not used	$S_{p,iso} = 1.0$	NITHA used Reference I-4-6	$S_{p,iso} = 0.7$					
		NITHA not used	$S_{p,iso} = 1.0$								
NITHA used Reference I-4-6	$S_{p,iso} = 0.7$										
I-4-5	Use a displacement-based/ADRS plot approach to designing the isolation plane characteristics: <ul style="list-style-type: none"> <li>checks made at the isolation plane centre-of-mass and critical corner.</li> </ul>	Confirm that isolation and superstructure characteristics still meet simplified design criteria. <table border="1"> <thead> <tr> <th></th> <th>LRB</th> <th>Curved sliding surface</th> </tr> </thead> <tbody> <tr> <td>Limiting change in <math>T_{eff}</math> ASCE 7-16: 17.4.1.7a</td> <td><math>Q_d &lt; K_d \Delta</math></td> <td><math>R &lt; \frac{\Delta}{\mu}</math></td> </tr> <tr> <td>Reliable restoring stiffness ASCE 7-16: 17.2.4.4</td> <td><math>K_d &gt; \frac{0.05W}{\Delta}</math></td> <td><math>R &lt; 20\Delta</math></td> </tr> </tbody> </table> Review effective stiffness and reliable restoring force of system based on nominal isolator properties. Must satisfy limits below per ASCE 7-16.		LRB	Curved sliding surface	Limiting change in $T_{eff}$ ASCE 7-16: 17.4.1.7a	$Q_d < K_d \Delta$	$R < \frac{\Delta}{\mu}$	Reliable restoring stiffness ASCE 7-16: 17.2.4.4	$K_d > \frac{0.05W}{\Delta}$	$R < 20\Delta$
	LRB	Curved sliding surface									
Limiting change in $T_{eff}$ ASCE 7-16: 17.4.1.7a	$Q_d < K_d \Delta$	$R < \frac{\Delta}{\mu}$									
Reliable restoring stiffness ASCE 7-16: 17.2.4.4	$K_d > \frac{0.05W}{\Delta}$	$R < 20\Delta$									
I-4-6	Is the design to result in a <i>Target Isolation Performance</i> or a full <i>Bearing Specification</i> ? Elastomeric bearings with CALS strain factors $\geq 1.2$ can maintain their design based on $S_{p,iso}$ as used to define the ADRS. Otherwise, their CALS shear displacement should be evaluated based on $S_{p,iso} = 1.0$ . Sliding surface bearings should be evaluated for CALS displacement using $S_{p,iso} = 1.0$ . This will also provide the rattle space size to suit CALS displacements (see Step S-4-8).	If a <i>Target Isolation Performance</i> specification, then no further iteration on the isolation plane design is needed. For a <i>Bearing Specification</i> include checks on the isolator characteristics, i.e. the actual design of the isolator unit itself for strain limits, bearing overlaps or friction interface limits. The above preliminary isolation plane data can then be used to establish actions from the superstructure that are used in turn to iterate on the isolation plane design. <ul style="list-style-type: none"> <li>In particular, the axial loads coming from the superstructure onto the isolator devices is needed.</li> <li>The axial loads will be a function of superstructure design ductility.</li> </ul>									

**Table 6-4: Design procedure for Type 4 isolated buildings (continued)**

Step	Procedure	Reference and specific information for design checks
<b>Isolation plane design (continued)</b>		
I-4-7	If isolation plane design is settled the final values of $Q_d$ and $K_{eff}$ can be used to set up the superstructure design.	If ULS net tension or uplift due to lateral response occurs at any of the isolator/bearing locations then an equivalent static analysis is not appropriate for design. A Type 2 or 3 approach is required.
<b>Superstructure ULS design</b>		
S-4-1	The superstructure design base shear is determined from the isolation system yield characteristics, with checks for wind load as per normal structural frame design.	—
S-4-2	From isolation system design the following information is available: <ul style="list-style-type: none"> <li>the isolation plane yield force: <math>Q_d</math></li> <li>effective period of the isolation system at ULS: <math>T_{eff,ULS}</math></li> <li>elastic 5% damping spectral definition as either NZS 1170.5 or site specific spectra: <math>Z, R, N, C_h</math>.</li> </ul>	—
S-4-3	Minimum design base shear for superstructure determined from the maximum of: <ul style="list-style-type: none"> <li><math>1.5 \times Q_{d,nom,elastomeric}</math> or <math>1.5 \times Q_{d,UB,friction}</math></li> <li><math>[V_{s,CALS}]/k_\mu</math></li> <li>wind ULS base shear force.</li> </ul>	$k_\mu = 1.0$ $S_{p,superstructure} = 1.0$ $\Phi$ as per material design standards for new buildings or seismic assessment guidelines (NZSEE, 2017)
S-4-4	Superstructure base shear can then be distributed vertically as equivalent lateral forces or via modal analysis.	See Section 5.5 for ESA force distribution method or Section 5.6 for modal response spectrum analysis approach.
S-4-5	Resulting structural actions can then be used for member design per material design standards or seismic assessment guidelines (NZSEE, 2017): <ul style="list-style-type: none"> <li>Following through the design with chosen <math>k_\mu = 1</math> and <math>S_{p,superstructure} = 1</math>.</li> </ul>	—
S-4-6	Once the design axial loads on the columns/wall ends are defined these should be checked against those previously used for the isolation plane and isolator unit design. If values are significantly different then iterate the isolation design. <ul style="list-style-type: none"> <li>To specify a valid design, it is recommended that minimum overlaps, shear strains and bearing pressures are reviewed at this point to mitigate the need for subsequent changes once a supplier is involved.</li> </ul>	Review net tension on isolators due to lateral response. <ul style="list-style-type: none"> <li>ULS: No net tension or uplift is allowed for in the simplified design approach. Verification using nonlinear time history is required if this is not satisfied.</li> <li>CALS: Tensile stress less than 2G on elastomeric bearings. Uplift on sliding surface bearings is acceptable but design bearing pressures should be set to provide a margin for impact related pressure peaks.</li> </ul>
<b>Substructure review</b>		
S-4-7	Typically, the superstructure does not have a specific CALS design. However, the actions of the superstructure under CALS demands are required to confirm the performance expectation, e.g., damage criteria and stability of the isolator units under peak displacement. <ul style="list-style-type: none"> <li>This requires axial loads on the isolators.</li> <li>Isolator CALS displacements are based on lower bound isolator properties.</li> </ul>	$k_\mu = 1.0$ $S_{p,superstructure} = 1.0$ $\Phi = 1.0$ Material properties use probable strengths

**Table 6-4: Design procedure for Type 4 isolated buildings (continued)**

Step	Procedure	Reference and specific information for design checks																
<b>Superstructure CALS review (continued)</b>																		
S-4-8	<p>Maximum CALS isolation displacements are used to confirm the movement allowances of various aspects of the structure to provide adequate clearance:</p> <ul style="list-style-type: none"> <li>• access and exit ways including stairs and lift shafts</li> <li>• items such as cladding panels where contact due to isolation plane movement could result in a localised falling object hazard</li> <li>• moat/rattle space to target CALS isolation maximum displacement. If this distance is not provided in the isolation plane design, then the percentage of current Code demand is reduced accordingly. Impact of this nature is not considered acceptable given the brittle nature of the superstructure.</li> </ul>	<table border="1"> <thead> <tr> <th colspan="2" data-bbox="852 383 1423 454">Isolation plane life-safety related aspects</th> </tr> <tr> <th colspan="2" data-bbox="852 454 1423 504">Brittle structure</th> </tr> </thead> <tbody> <tr> <td data-bbox="852 504 1031 584">NITHA not used</td> <td data-bbox="1031 504 1423 584"><math>S_{p,iso} = 1.0</math></td> </tr> <tr> <td data-bbox="852 584 1031 665">NITHA used</td> <td data-bbox="1031 584 1423 665"><math>S_{p,iso} = 1.0</math></td> </tr> <tr> <th colspan="2" data-bbox="852 665 1423 725">Isolation plane moat/ rattle space</th> </tr> <tr> <th colspan="2" data-bbox="852 725 1423 775">Brittle structure</th> </tr> <tr> <td data-bbox="852 775 1031 855">NITHA not used</td> <td data-bbox="1031 775 1423 855"><math>S_{p,iso} = 1.0</math></td> </tr> <tr> <td data-bbox="852 855 1031 936">NITHA used</td> <td data-bbox="1031 855 1423 936"><math>S_{p,iso} = 1.0</math></td> </tr> </tbody> </table>	Isolation plane life-safety related aspects		Brittle structure		NITHA not used	$S_{p,iso} = 1.0$	NITHA used	$S_{p,iso} = 1.0$	Isolation plane moat/ rattle space		Brittle structure		NITHA not used	$S_{p,iso} = 1.0$	NITHA used	$S_{p,iso} = 1.0$
Isolation plane life-safety related aspects																		
Brittle structure																		
NITHA not used	$S_{p,iso} = 1.0$																	
NITHA used	$S_{p,iso} = 1.0$																	
Isolation plane moat/ rattle space																		
Brittle structure																		
NITHA not used	$S_{p,iso} = 1.0$																	
NITHA used	$S_{p,iso} = 1.0$																	
<b>Substructure review</b>																		
SS-4-1	<ul style="list-style-type: none"> <li>• Substructure capacity design demands are based on upper bound CALS analysis forces and lower bound CALS analysis displacements of the isolation plane.</li> <li>• <math>k_{\mu} = 1.0</math></li> </ul>	—																

# COMMENTARY

Section	Commentary
6	<p><b>Design</b></p> <p>This chapter links the design philosophy and performance criteria outlined in Chapter 2 with the analysis approaches in Chapter 5.</p> <p>Type 1 isolated buildings can be adequately represented by the SDOF assumption, so the analysis approach to determining and verifying the isolation system design can be limited in scope to a basic, hand-derived equivalent static approach.</p> <p>Irregular or complex isolated structures may be adequately captured using linear-elastic modal analysis techniques (a Type 2 design approach), or may also require a Type 3 approach as described below.</p> <p>By contrast, ductile structures are known to exhibit period lengthening as a result of their inelastic response. Such shifts will bring the superstructure period closer to the isolation period, which can reduce the effectiveness of the isolation. In some circumstances this can result in amplification of demand passed up to the superstructure. For structures expected to develop a moderate level of ductility at or beyond ULS demands, a simple equivalent static or elastic analysis is considered inadequate to capture these effects. Therefore, a nonlinear time history analysis (NITHA) is the recommended procedure to adequately identify the overall superstructure and isolation plane performance – this is considered a Type 3 design and verification procedure.</p> <p>Type 4 isolated buildings are those that have potentially brittle superstructures.</p> <p>While superstructure ductility (and detailing to be applied) are typical first decisions related to new seismically isolated buildings, in some cases it is possible that the structure being isolated is considered brittle in its seismic response. This is often the case for existing buildings but may also apply to certain special types of new structure. It is recommended that systems where the superstructure has little, or no robustness are treated with a level of conservatism that is consistent with considerations that would be given to similar non-isolated structures.</p> <p><b>Verification of performance</b></p> <p>Verification of performance is intended to comprise analysis in accordance with NZS 1170.5, with modifications as per Chapter 5, and derivation of capacities in accordance with the relevant materials standards. The layout of this guideline is based upon using displacement-based design techniques to establish the bearing displacements/rattle space size, then using the resulting force coefficients modified for dynamic effects where appropriate to design the superstructure and substructure.</p> <p>Aside from displacement-based design for the isolation system and procedural aspects around time history analysis the main departure from NZS 1170.5 is in the use of <math>\pm 0.05b</math> accidental eccentricity in contrast with <math>\pm 0.1b</math> in NZS 1170.5 Clause 5.3.2. This reduction is seen as appropriate due to:</p> <ul style="list-style-type: none"> <li>• control of structural variability in the isolation plane through design and proof testing</li> <li>• offshore precedent: all other isolation codes utilise 5% accidental eccentricity.</li> </ul> <p>While it would be more in accordance with New Zealand standards to use 5% eccentricity for isolation plane design and 10% for the superstructure, the additional complexity of this and, accordingly, the possible source of errors in the analysis are considered to outweigh the benefits.</p> <p>It is noted that friction-based isolation systems, in theory and in practice, exhibit negligible eccentricity due to the isolator shear forces being proportional to axial load (and therefore tributary mass). While this is a positive behaviour to consider in design, incorporation of eccentricity (5%) is considered reasonable to allow for unforeseen dynamic effects from the superstructure.</p> <p>Designing a superstructure with inherent ductility capacity is encouraged. However, it is important to understand that energy absorption in the superstructure does not act in the same way as a non-isolated structure. This is principally due to the interaction of the superstructure movement with the isolation plane displacement, particularly if the superstructure develops sufficient inelastic actions that its (fixed-based) period lengthens. Such interaction is not easily predictable. Superstructure yielding can take the form of a series of accumulating ratcheting effects that can currently only be predicted by complex nonlinear time history analysis of the superstructure and substructure together.</p>

Section	Commentary
<p><b>6.1</b></p>	<p><b>The design process</b></p> <p>The design process for a seismically isolated structure can generally be considered in two stages, as follows:</p> <ol style="list-style-type: none"> <li>1. Determine the basic isolation system using a rigid-body SDOF approximation of the overall isolated structure. This is consistent with the intent to provide a final design that separates the superstructure fundamental periods from the isolation system period such that the predominant response is governed by the isolation, while minimising the contributions from the superstructure dynamic characteristics.</li> <li>2. Once a suitable set of isolation system parameters has been determined, the designer will typically look to complete the superstructure design based on this isolation response. The superstructure design inputs will depend on the isolation characteristics, the assumed inelastic behaviour of the superstructure, and the choice of whether or not capacity design is applied.</li> </ol> <p>In many instances, this may provide sufficient information to prepare a specification that can be distributed to suppliers if it is expected that they provide compliant isolator designs in order to meet the performance specifications of the isolation system. However, some designers may choose to review the actual bearing performance and assess any potential issues or limitations associated with the performance targets and loads that the isolators will experience. In this case, the design is likely to become iterative as the imposed axial and shear strains are reviewed and the bearing designs adjusted to account for acceptable material limits.</p> <p>The isolation design is based on nominal isolator properties, with specific checks made using upper and lower bound adjustments. The isolation ULS period and displacement estimation can then be determined from the nominal properties, with these values being used to review isolation plane effective stiffness and reliable restoring force. Subsequent checks for isolation maximum CALS displacement are based on lower bound properties, and superstructure design forces derived from ULS upper bound isolator properties.</p> <p>The design of the superstructure and substructure will require the output from the isolation design process. However, their actual design will typically be covered by requirements and guidance available in the appropriate current New Zealand standards.</p> <p>A complete seismic isolation system design will typically capture the performance at the ULS design earthquake (note that US practice refers to Design Basis Earthquake or DBE). For the isolation plane this is typically the focus for the isolation period, energy dissipation and isolation plane yield coefficient.</p> <p>It is internationally accepted practice to also consider the performance of the isolation system when subject to displacements from stronger shaking from a rare earthquake (in US terms a Maximum Considered Earthquake or MCE). This might be considered equivalent to the collapse avoidance limit state (CALS) referred to in the New Zealand context. At this level of isolation displacement, the key aspects for review are seismic gap or moat clearance and isolation plane stability for which individual bearings are considered under maximum compression loads at maximum displacements. SLS performance needs specific checking as the isolation may not have yielded and therefore the structure is likely to be responding in a fixed base mode with low levels of damping. It is a requirement that no damage requiring repair occurs at SLS1.</p> <p>Usually, serviceability is only checked if wind loads are close to this value and the isolation design has been governed by wind loading minimum strengths. Note, however, the SLS2 requirements for IL4 structures might well find the isolation plane yielding, in which case explicit design should be carried out.</p> <p>ULS design will typically be used to review aspects of strength design in both the sub-structure and superstructure.</p> <p>In most cases the strength design of the superstructure will be directly linked to the isolation plane yield coefficient, which will be developed using the ULS demands.</p> <p>For earthquakes exceeding ULS demands the superstructure is generally accepted to have developed a level of ductility. In the case of brittle buildings there may be little additional dependable capacity to resist earthquake shaking greater than ULS.</p>

Section	Commentary
<p><b>6.1</b></p> <p><i>Continued</i></p>	<p><b>Type 1: Simple</b></p> <p>The key aspect of Type 1 isolation design is the simplicity and regularity of the superstructure. The equivalent static isolation design will not capture effects induced by irregularities such as significant in-plan torsion, bearing tension or uplift, or pounding effects from contact with the moat walls.</p> <p>The design inputs are therefore kept conservative, and a minimum level of ductile detailing is recommended. For reinforced concrete structures, the detailing should correspond to 'limited ductility plastic rotation' definitions in NZS 3101:2006. For structural steel the detailing should match a structure category of at least Category 2 in NZS 3404:2009.</p> <p>Other international isolation design codes provide guidance for the isolation plane to maintain a limiting change in effective isolation period and minimum reliable restoring force. Both constraints are intended to provide a system with characteristics that are within well understood bounds and known to produce generally reliable isolation behaviour.</p> <p>If uplift or tension stresses do occur in the bearings, the designer will need to review whether this is under ULS or CALS demands. If the latter, then the building will be a Type 2 (normal). If the uplift is a result of ULS or (low level), the building will be Type 3 (Complex or Ductile) and a more complex verification will be required.</p> <p><b>Type 2: General</b></p> <p>These designs will generally cover irregular superstructures without geometric limitations. However, situations where multiple structures sit on a single isolation plane or where multiple isolation planes are being used should be considered as Type 3 (Complex or Ductile) buildings.</p> <p>The superstructure design might also incorporate a minor amount of inelastic response under ULS demands by using <math>k_u = 1.25</math>. In this case for reinforced concrete structures the detailing should correspond to 'ductile plastic rotation' definitions in NZS 3101. For structural steel the detailing should match a structure category of at least Category 1 in NZS 3404.</p> <p>A limited amount of isolator net tension or uplift is allowed; provided it does not significantly affect the isolation performance. However, in general this will only apply for elastomeric bearings as the gap elements required to model sliding surface separation from a puck cannot be used in a linear-elastic modal analysis.</p> <p>The same constraints of isolation effective stiffness and restoring force, as noted earlier for Type 1, apply to Type 2 designs.</p> <p><b>Type 3: Complex or Ductile</b></p> <p>[No commentary.]</p> <p><b>Type 4: Brittle</b></p> <p>Although Type 4 isolation designs could apply to new structures with brittle characteristics (e.g. glass structures or monuments), the most common application is likely be to the seismic performance enhancement of existing structures.</p> <p>Where applied to existing structures, the overall design needs consideration and coordination with 'The Seismic Assessment of Existing Buildings: Technical Guidelines for Engineering Assessments' (NZSEE, 2017). It is recommended that the superstructure design review uses capacities in line with the seismic assessment guidelines' recommendations and that the isolation, associated isolation plane structure and substructure use dependable capacities in design.</p> <p><b>Damage control limit states</b></p> <p>For many designs, these will be other damage control limit states (DCLS) that have been identified by the owner and designer, and that may be associated with performance measures not necessarily aligned with those associated with the SLS1 and SLS2 return periods. Some DCLS criteria, such as the provision of floor response spectra, may require a method of analysis not necessarily required for the ULS and CALS design.</p> <p>For each of the limit states it will be necessary to establish the effective period of the isolation system and its equivalent viscous damping for the hazard spectra appropriate to the desired risk factor. Most base isolation systems are essentially hysteretic in their performance and for low hazard parameters may be within their initial elastic range. In this case no additional damping will be available.</p> <p>For NITHA methods the selection and scaling of records to be used will require review. The actual records considered appropriate for scaling may well be different from those selected for the ULS risk analyses, and the period range over which the records are matched to the hazard spectra will be different.</p>

Section	Commentary
6.2	<p><b>Structural performance factor <math>S_p</math></b></p> <p>The structural performance factor, <math>S_p</math>, has been present within the seismic section of the New Zealand loading code since NZS 4203:1992. Its position within the standard has always been as a reduction to the uniform hazard design spectrum. However, its presence has generally been interpreted as representing structural capacity influences.</p> <p>The inclusion of <math>S_p</math>, the material strength reduction factors (<math>\Phi</math>) and superstructure design displacement ductility (<math>\mu_{\text{superstructure}}</math>) allows the demands and basic strength design procedures from NZS 1170.5 and the material design standards to be used by designers. It is intended that the elements of structure above or below the isolation plane are designed using applicable New Zealand standards.</p> <p>Of these three factors, <math>S_p</math> requires some discussion to help the designer understand its purpose in the isolation design process and also in the superstructure design.</p> <p>The inclusion of <math>S_p</math> in the isolation system design provides a way to include aspects of the isolation plane and substructure response which are otherwise not typically included in analysis or design techniques. Various earlier publications justifying <math>S_p</math> for structures in general have identified aspects of response that are applicable to the isolation system design. These include:</p> <ul style="list-style-type: none"> <li>• foundation radiation damping</li> <li>• inherent superstructure damping reducing the demands applied to the bearings</li> <li>• inherent redundancy in the system by virtue of (typically) a large number of isolator elements such that the failure of one bearing would not constitute an isolation system failure, provided this is not a failure causing an immediate loss of gravity support</li> <li>• designing to a peak cyclic response when in reality the peak only occurs once during an earthquake event</li> <li>• the requirement in NZS 1170.5 Clause 4.4.1 for a value of 1.0 applying to global stability (around the foundation) of the whole structure; i.e. “when considering lateral stability of a whole structure against sliding or toppling. ... <math>S_p</math> shall be taken as 1.0”.</li> </ul> <p>This guideline is intended to provide a way to tie isolation design to the existing New Zealand design standards, and to this extent maintains the inclusion of <math>S_p</math>. Due to the design process for isolated buildings essentially comprising two parts – first, the isolation design, and second, the superstructure design – multiple definitions of <math>S_p</math> exist for a full design.</p> <p>The first definition used is <math>S_{p,\text{iso}}</math> which is the value applied to the isolation design. This value is used as input to record scaling for Type 3 analyses. However, if using a mixed isolation system, such as LRB + flat-plate friction sliders, multiple runs with varying <math>S_{p,\text{iso}}</math> will be required to provide sufficient displacement margins (i.e. with rattle space and slider displacement limits verified by <math>S_{p,\text{iso}} = 1.0</math>). These will also need to accommodate the isolator property bounding recommendations.</p> <p>As described in Chapter 5, the application of <math>S_{p,\text{iso}}</math> to the ADRS design method needs to be carefully followed so the elastic acceleration and displacement ordinates are scaled correctly.</p> <p>For the superstructure design, <math>S_{p,\text{superstructure}}</math> is the value assigned to the superstructure lateral force-resisting system, commensurate with the ductility capacity (<math>k_{\mu,\text{superstructure}}</math>) of the frame or wall system.</p> <p>Regarding the use of NITHA verification, a significant body of research was carried out in 2005 as part of the NZS 1170.5 draft development (Tremayne and Kelly, 2005). This led to the calibration of <math>S_p = 0.85</math> for deriving the target spectrum for earthquake record scaling which correlates to the use of <math>S_p = 0.7</math> for a response spectrum based design.</p> <p>The flowchart provided in this chapter gives specific guidance on the values of <math>S_{p,\text{iso}}</math> that are applicable given the type of analysis used to verify the isolation system design. This input will typically be unity for Type 1 and 2 designs. However, when NITHA is used as performance verification (Type 3) a value less than 1.0 can be used. Isolators such as flat-sliders or curved surface sliders are verified with time history analyses in which the record scaling uses <math>S_{p,\text{iso}} = 1.0</math>, which accounts for the potential loss of gravity support. Note that the <math>\alpha</math>-factors used to define the CALS also require additional displacement capacity for less resilient isolation systems.</p>



Section	Commentary
<p><b>6.3</b></p>	<p><b>Superstructure ductility</b></p> <p>In the New Zealand design codes, the structural ductility factor (<math>\mu</math>) is defined as the ratio of displacement at ultimate limit state to displacement when the structure reaches its nominal yield displacement.</p> <p>To relate this ductility value to the assumed equal energy or equal displacement concepts which are a function of first-mode structural period, NZS 1170.5 uses a factor <math>k_{\mu}</math> that provides the actual reduction of design actions. As this was developed with typical ‘fixed-based’ structures in mind, the existing correlation between ductility (<math>\mu</math>) and <math>k_{\mu}</math> does not carry over to seismically isolated structures, where the majority of deformation occurs in the isolators and very little of the total displacement demand is associated with the superstructure.</p> <p>To incorporate the concept of ductile action being used to reduce superstructure design actions this guideline does not use a value of <math>\mu</math> to determine the reduction. Instead, the designer may choose a value of <math>k_{\mu}</math> associated with the ULS, from 1 (implying linear-elastic response) up to a maximum value of 1.25 (being equivalent to nominally ductile response). This is intended to present the design action reduction as being dissociated from the typical application of a ductility factor. Where NITHA is used, the ductility of the structure is not really monitored but inelastic deformations in the yielding regions are tracked, which is a more fundamental level of performance review. The designer may apply a value of <math>k_{\mu}</math> greater than 1.25 if NITHA verification is being used. However, it is recommended that the reduction value used is limited such that the design base shear for the superstructure when the isolation reaches the CALS displacement is not reduced by more than 3.0 from an elastic response to the isolation plane overstrength associated to that displacement.</p> <p>The level of ductile detailing applied in the superstructure design is also recognised in the design approaches, and in the definition of the collapse avoidance limit state (CALS) design earthquake intensity. While seismic isolation will generally protect the superstructure from significant ductile action, it should be recognised that good seismic detailing practice is equally valid for these structures and the designer should seek to apply these principles as they would do in non-isolated structures.</p> <p>The designer needs to carefully consider and apply the correct detailing procedures for the superstructure, in keeping with the material design standards that still govern the structure above the isolation plane. It is highlighted here that the various design standards do not necessarily use the same notation from one document to the next. The designer should also consider that the designation of detailing, when correlated to ductility in the standards, also provides an implicit allowance for reliable behaviour should demands exceed ULS.</p>
<p><b>6.4</b></p>	<p><b>Capacity design of the superstructure</b></p> <p>For Type 1 and 2 buildings, where no explicit review of inelastic deformations is carried out, capacity design is required. This should ensure that the potential collapse mechanism is controlled. Capacity design effects need not be greater than those determined from the application of the upper bound base shear from the CALS event.</p> <p>For Type 3 buildings where verification by NITHA will allow the engineer to directly review plastic deformations, the assumed value <math>k_{\mu}</math> can be reviewed against the actual deformations and also to confirm that the inelastic mechanism beyond ULS is controlled.</p>
<p><b>6.5</b></p>	<p><b>Bounding isolator property variability</b></p> <p>Isolator variability and the overall behaviour of isolation systems should be considered in the design, specification and supply of isolators. Individual isolators or the system overall will not behave with the nominal properties assumed for design. Isolators have variable properties due to many physical parameters during the manufacture and working life of the units. Recognition of these variations through explicit design is strongly recommended in order for an isolation plane and associated superstructure or substructure design to be adequately completed.</p>

Section	Commentary																																																									
<p><b>6.5</b> <i>Continued</i></p>	<p>Recommendations for incorporating isolation variability during the design process are provided in both ASCE and Eurocode standards. Rather than direct users of this guideline to one particular approach, a summary of the two references is provided below, with guidance limited to recognising the various parameters that might affect the isolator variability. It is left to the designer to interpret and apply these as they see appropriate for each project. However, the two approaches should not be mixed; i.e. the designer should not ‘cherry pick’ the more favourable parts from various codes. If there is uncertainty in what components are applicable it is recommended that the designer considers using a more conservative estimate of bounding factors.</p> <p>The application of the design outcomes from the bounding approach is summarised here to help the designer understand how these results can be combined to provide suitable design criteria for the various components of the isolation system (substructure, isolators, isolator stability structures, rattle space and superstructure).</p> <p>Table 6-5 provides a look-up reference to which bounding design or analysis cases correspond to the various limit states that might be checked through the course of the isolation and superstructure design. The entries correspond to the following definitions:</p> <ul style="list-style-type: none"> <li>• performance: confirm isolation plane and/or superstructure response against design intents and targets. This will typically be displacement related.</li> <li>• forces: review linear and nonlinear response of elements against design targets and allowances. If the superstructure is required to remain elastic these design checks are required to demonstrate that the structure has sufficient capacity.</li> <li>• deformations: Specific superstructure checks are required for Type 3 ductile response of the superstructure under CALS demands. These are necessary to ensure that the recorded plastic rotations are not excessive and that collapse prevention is satisfied.</li> </ul>																																																									
<p><b>Table 6-5: Limit state checks and corresponding bounding design and analysis cases</b></p>																																																										
<table border="1" style="width: 100%; border-collapse: collapse;"> <thead> <tr> <th style="background-color: #800000; color: white;">Limit state</th> <th style="background-color: #800000; color: white;">Demand parameter</th> <th style="background-color: #800000; color: white;">Upper bound</th> <th style="background-color: #800000; color: white;">Nominal</th> <th style="background-color: #800000; color: white;">Lower bound</th> </tr> </thead> <tbody> <tr> <td rowspan="3" style="background-color: #d3d3d3;">SLS1 and DCLS</td> <td>Superstructure forces and isolator stability structure</td> <td style="text-align: center;">–</td> <td>Performance check</td> <td style="text-align: center;">–</td> </tr> <tr> <td>Superstructure <math>\Delta</math></td> <td style="text-align: center;">–</td> <td>Performance check</td> <td style="text-align: center;">–</td> </tr> <tr> <td>Isolation <math>\Delta</math></td> <td style="text-align: center;">–</td> <td>Performance check</td> <td style="text-align: center;">–</td> </tr> <tr> <td rowspan="3" style="background-color: #d3d3d3;">SLS 2</td> <td>Superstructure forces and isolator stability structure</td> <td style="text-align: center;">–</td> <td>Performance check</td> <td style="text-align: center;">–</td> </tr> <tr> <td>Superstructure <math>\Delta</math></td> <td style="text-align: center;">–</td> <td>Performance check</td> <td style="text-align: center;">–</td> </tr> <tr> <td>Isolation <math>\Delta</math></td> <td style="text-align: center;">–</td> <td>Performance check</td> <td style="text-align: center;">–</td> </tr> <tr> <td rowspan="3" style="background-color: #d3d3d3;">ULS</td> <td>Superstructure forces and isolator stability structure</td> <td>Design check</td> <td style="text-align: center;">–</td> <td style="text-align: center;">–</td> </tr> <tr> <td>Superstructure <math>\Delta</math></td> <td>Design check</td> <td style="text-align: center;">–</td> <td style="text-align: center;">–</td> </tr> <tr> <td>Isolation <math>\Delta</math></td> <td style="text-align: center;">–</td> <td>Design check + specification input</td> <td style="text-align: center;">–</td> </tr> <tr> <td rowspan="3" style="background-color: #d3d3d3;">CALS</td> <td>Isolator stability structure check</td> <td>Performance check</td> <td style="text-align: center;">–</td> <td style="text-align: center;">–</td> </tr> <tr> <td>Superstructure <math>\Delta</math></td> <td>Performance check</td> <td style="text-align: center;">–</td> <td style="text-align: center;">–</td> </tr> <tr> <td>Isolator and rattle space <math>\Delta</math></td> <td style="text-align: center;">–</td> <td>Specification input</td> <td>Design check</td> </tr> </tbody> </table>		Limit state	Demand parameter	Upper bound	Nominal	Lower bound	SLS1 and DCLS	Superstructure forces and isolator stability structure	–	Performance check	–	Superstructure $\Delta$	–	Performance check	–	Isolation $\Delta$	–	Performance check	–	SLS 2	Superstructure forces and isolator stability structure	–	Performance check	–	Superstructure $\Delta$	–	Performance check	–	Isolation $\Delta$	–	Performance check	–	ULS	Superstructure forces and isolator stability structure	Design check	–	–	Superstructure $\Delta$	Design check	–	–	Isolation $\Delta$	–	Design check + specification input	–	CALS	Isolator stability structure check	Performance check	–	–	Superstructure $\Delta$	Performance check	–	–	Isolator and rattle space $\Delta$	–	Specification input	Design check
Limit state	Demand parameter	Upper bound	Nominal	Lower bound																																																						
SLS1 and DCLS	Superstructure forces and isolator stability structure	–	Performance check	–																																																						
	Superstructure $\Delta$	–	Performance check	–																																																						
	Isolation $\Delta$	–	Performance check	–																																																						
SLS 2	Superstructure forces and isolator stability structure	–	Performance check	–																																																						
	Superstructure $\Delta$	–	Performance check	–																																																						
	Isolation $\Delta$	–	Performance check	–																																																						
ULS	Superstructure forces and isolator stability structure	Design check	–	–																																																						
	Superstructure $\Delta$	Design check	–	–																																																						
	Isolation $\Delta$	–	Design check + specification input	–																																																						
CALS	Isolator stability structure check	Performance check	–	–																																																						
	Superstructure $\Delta$	Performance check	–	–																																																						
	Isolator and rattle space $\Delta$	–	Specification input	Design check																																																						

Section	Commentary
<p><b>6.5</b></p> <p><i>Continued</i></p>	<p><b>ASCE 7 Chapter 17</b></p> <p>ASCE 7-16 Chapter 17 requires bounding (upper and lower bound) properties of isolation system components to be developed to account for the following:</p> <ul style="list-style-type: none"> <li>• ageing and environmental effects including creep, fatigue, contamination, operating temperature and duration of exposure, and wear over the life of the structure</li> <li>• considering variation in prototype isolator unit properties due to required variation in vertical test load, rate of test loading or velocity effects, effects of heating during cyclic motion, history of loading, ‘scragging’, and other potential sources of variation measured by prototype testing</li> <li>• permitted manufacturing specification tolerances to determine acceptability of production isolators.</li> </ul> <p>The standard requires that the maximum and minimum property modification factors (<math>\lambda_{max}</math> and <math>\lambda_{min}</math>) are developed so that when applied to the nominal design parameters the resulting response envelopes the hysteretic response for the range of demands up to and including the maximum displacement <math>\pm D_M</math>.</p> <p>The maximum and minimum lambda factors are determined from combinations of contributing property modification factors in accordance with Equations 6.1 and 6.2 below (Equations from ASCE 7-17).</p> $\lambda_{max} = \left( 1 + \left( 0.75 * (\lambda_{(ae,max)} - 1) \right) \right) * \lambda_{(test,max)} * \lambda_{(spec,max)} \leq 1.8 \quad \text{(Eq. 6-1)}$ $\lambda_{min} = \left( 1 + \left( 0.75 * (1 - \lambda_{(ae,min)}) \right) \right) * \lambda_{(test,min)} * \lambda_{(spec,min)} \geq 0.6 \quad \text{(Eq. 6-2)}$ <p>where:</p> <p><math>\lambda_{(ae,max)}</math> = property modification factor for calculation of the maximum value of the isolator property of interest, used to account for ageing effects and environmental conditions</p> <p><math>\lambda_{(test,max)}</math> = property modification factor for calculation of the maximum value of the isolator property of interest, used to account for heating, rate of loading and scragging</p> <p><math>\lambda_{(spec,max)}</math> = property modification factor for calculation of the maximum value of the isolator property of interest, used to account for permissible manufacturing variation on the average properties of a group of same-sized isolators</p> <p>‘min’ subscript values are the corresponding factors used to calculate the minimum value of the isolator property of interest.</p> <p>Where manufacturer-specific qualification test data have been approved by a Registered Design Professional, or RDP (in New Zealand, this would be the professional engineer who is responsible for the design and who would sign the Producer Statement, or PS1), these data are permitted to be used to develop the property modification factors. In the absence of such approved qualification test data the maximum (1.8) and minimum (0.6) limits of Equations 6.1 and 6.2 are required to apply. Figure 6-8 and Figure 6-9 show the default lambda values provided in the Commentary to ASCE 7-16 Chapter 17, for ‘unknown’ and ‘quality’ manufacturers.</p> <p>‘Unknown’ manufacturers are described as those having no qualification test data. It is noted that these detailed values have been put in the Commentary and therefore would be considered as recommended and not mandatory. The specified default limits in the absence of test data and the range of 3.0 between the lower and upper default limits appear to be much larger than has been typically considered for projects in New Zealand. The specified default values applicable to isolators from ‘quality’ manufacturers have significantly tighter ranges.</p> <p>From ASCE 7-16 Clause 17.2.8.6, the isolation system effective stiffness <math>k_M</math> and system effective damping <math>\beta_M</math> at the maximum displacement <math>D_M</math> are required to be calculated using both upper and lower bound force-displacement behaviour of individual isolator devices. <math>D_M</math> is the displacement of the centre of mass at the Maximum Considered Earthquake (MCE) level. The commentary of ASCE 7-16 makes it clear that the lambda factors are applied to both yield level and post-yield stiffness for elastomeric bearings, and only to the friction coefficients for slider type bearings.</p> <p>Note that ASCE 7-16 requires prototype tests to be performed separately on two full-size specimens of each predominant type and size of isolator unit. Testing of similar units is accepted instead of actual prototype tests if the similar unit satisfies various comparative limits on size, type and materials. (Clause 17.8.2.7 of ASCE 7-16). Testing of 100% of production bearings is required in combined compression and shear at not less than two thirds of the maximum displacement <math>D_M</math>. Where the bearing types are known to exhibit some velocity dependence, testing at velocity is necessary. Typically, this is included in the testing as average velocity. Peak velocity may also be considered, although the differences are not usually significant.</p>

**Section**

**Commentary**

**6.5**

Continued

**Table C17.2-6 Default Upper and Lower Bound Multipliers for Unknown Manufacturers**

Variable	Unlubricated Interfaces, $\mu$ or $Q_d$	Lubricated (Liquid) Interfaces, $\mu$ or $Q_d$	Plain Low Damping Elastomeric, K	Lead Rubber Bearing (LRB), $K_d$	Lead Rubber Bearing (LRB), $Q_d$	High-Damping Rubber (HDR), $K_d$	High-Damping Rubber (HDR), $Q_d$
<b>Example: Aging and Environmental Factors</b>							
Aging, $\lambda_a$	1.3	1.8	1.3	1.3	1	1.4	1.3
Contamination, $\lambda_c$	1.2	1.4	1	1	1	1	1
Example Upper Bound, $\lambda_{(ae, max)}$	1.56	2.52	1.3	1.3	1	1.4	1.3
Example Lower Bound, $\lambda_{(ae, min)}$	1	1	1	1	1	1	1
<b>Example: Testing Factors</b>							
All cyclic effects, Upper	1.3	1.3	1.3	1.3	1.6	1.5	1.3
All cyclic effects, Lower	0.7	0.7	0.9	0.9	0.9	0.9	0.9
Example Upper Bound, $\lambda_{(test, max)}$	1.3	1.3	1.3	1.3	1.6	1.5	1.3
Example Lower Bound, $\lambda_{(test, min)}$	0.7	0.7	0.9	0.9	0.9	0.9	0.9
$\lambda_{(PM, max)} = (1 + (0.75 * (\lambda_{(ae, max)} - 1))) * \lambda_{(test, max)}$	1.85	2.78	1.59	1.59	1.6	1.95	1.59
$\lambda_{(PM, min)} = (1 + (0.75 * (1 - \lambda_{(ae, min)}))) * \lambda_{(test, min)}$	0.7	0.7	0.9	0.9	0.9	0.9	0.9
Lambda factor for Spec. Tolerance, $\lambda_{(spec, max)}$	1.15	1.15	1.15	1.15	1.15	1.15	1.15
Lambda factor for Spec. Tolerance, $\lambda_{(spec, min)}$	0.85	0.85	0.85	0.85	0.85	0.85	0.85
Upper Bound Design Property Multiplier	2.12	3.2	1.83	1.83	1.84	2.24	1.83
Lower Bound Design Property Multiplier	0.6	0.6	0.77	0.77	0.77	0.77	0.77
Default Upper Bound Design Property Multiplier	2.1	3.2	1.8	1.8	1.8	2.2	1.8
Default Lower Bound Design Property Multiplier	0.6	0.6	0.8	0.8	0.8	0.8	0.8

Note:  $\lambda_{PM}$  is the lambda value for testing and environmental effects.

*Figure 6-8: Default upper and lower bound multipliers for 'unknown' manufacturers (from ACSE 7-2016 Chapter C17)*

**Table C17.2-7 Default Upper and Lower Bound Multipliers for Quality Manufacturers**

Variable	Unlubricated PTFE, $\mu$	Lubricated PTFE, $\mu$	Rolling/Sliding, K2	Plain Elastomeric, K	Lead rubber bearing (LRB), K2	Lead rubber bearing (LRB), $Q_d$	High-Damping Rubber (HDR), $Q_d$	High-Damping Rubber (HDR), $K_d$
<b>Example: Aging and Environmental Factors</b>								
Aging, $\lambda_a$	1.10	1.50	1.00	1.10	1.10	1.00	1.20	1.20
Contamination, $\lambda_c$	1.10	1.10	1.00	1.00	1.00	1.00	1.00	1.00
Example Upper Bound, $\lambda_{(ae, max)}$	1.21	1.65	1.00	1.10	1.10	1.00	1.20	1.20
Example Lower Bound, $\lambda_{(ae, min)}$	1.00	1.00	1.00	1.00	1.00	1.00	1.00	1.00
<b>Example: Testing Factors</b>								
All cyclic effects, Upper	1.20	1.30	1.00	1.03	1.03	1.30	1.50	1.30
All cyclic effects, Lower	0.95	0.95	1.00	0.98	0.98	0.95	0.95	0.95
Example Upper Bound, $\lambda_{(test, max)}$	1.20	1.30	1.00	1.03	1.03	1.30	1.50	1.30
Example Lower Bound, $\lambda_{(test, min)}$	0.95	0.95	1.00	0.98	0.98	0.95	0.95	0.95
$\lambda_{(PM, max)} = (1 + (0.75 * (\lambda_{(ae, max)} - 1))) * \lambda_{(test, max)}$	1.39	1.93	1.00	1.11	1.11	1.30	1.73	1.50
$\lambda_{(PM, min)} = (1 + (0.75 * (1 - \lambda_{(ae, min)}))) * \lambda_{(test, min)}$	0.95	0.95	1.00	0.98	0.98	0.95	0.95	0.95
Lambda factor for Spec. Tolerance, $\lambda_{(spec, max)}$	1.15	1.15	1.00	1.15	1.15	1.15	1.15	1.15
Lambda factor for Spec. Tolerance, $\lambda_{(spec, min)}$	0.85	0.85	1.00	0.85	0.85	0.85	0.85	0.85
Upper Bound Design Property Multiplier	1.60	2.22	1.00	1.27	1.27	1.50	1.98	1.72
Lower Bound Design Property Multiplier	0.81	0.81	1.00	0.83	0.83	0.81	0.81	0.81
Default Upper Bound Design Property Multiplier	1.6	2.25	1	1.3	1.3	1.5	2	1.7
Default Lower Bound Design Property Multiplier	0.8	0.8	1	0.8	0.8	0.8	0.8	0.8

Note:  $\lambda_{PM}$  is the lambda value for testing and environmental effects.

*Figure 6-9: Default upper and lower bound multipliers for 'quality' manufacturers (from ACSE 7-2016 Chapter C17)*

**McVitty and Constantinou (2015)**

McVitty and Constantinou recently provided commentary to practising engineers using ASCE 7-16 Chapter 17 for design of seismically isolated structures in their report entitled 'Property Modification Factors for Seismic Isolators: Design Guidance for Buildings'. They note their report does not strictly follow all provisions of ASCE 7-16, but it provides illustrations of property modification factors, e.g. for elastomeric (lead rubber and natural rubber) isolators and triple pendulum (trademark name EPS) isolation systems. For each system type, the property modification factors are illustrated for three scenarios: (a) assuming there is no qualification test data available, (b) using either prototype test or similar test data, and (c) having a complete set of production bearing test data (which is perhaps of little practical use if bearings are already manufactured).

Section	Commentary																																																																																							
<p><b>6.5</b></p> <p><i>Continued</i></p>	<p>The report summarises the lambda factors in Section 8 and Tables 8-2 to 8-9, for example elastomeric / lead rubber and Friction Pendulum™ type isolation systems. The report notes that factors are project specific, manufacturer specific and also dependent on the materials used, so these factors cannot simply be adopted for other designs. However, it would appear that the lambda values determined may be useful guidance for designers of similar systems.</p> <p>McVitty and Constantinou propose a number of amendments to ASCE 7-16, including:</p> <ul style="list-style-type: none"> <li>• determining <math>\lambda_{(test, max)}</math> as the ratio of the first cycle property value obtained from prototype testing to the nominal property value</li> <li>• determining <math>\lambda_{(test, min)}</math> as the ratio of the third cycle (or other cycle chosen by the engineer) property value obtained from prototype testing to the nominal property value</li> <li>• requiring less dynamic testing of prototype units, at the effective period at maximum displacement (MCE).</li> </ul> <p>Note that prototype testing leads to determination of <math>\lambda_{(test)}</math> values but the variability factors due to ageing and manufacturing variations must still be accounted for separately. Bearing production needs to meet limits allowed for by <math>\lambda_{spec}</math>, i.e. <math>\pm 15\%</math> of the specified nominal value.</p> <p>Table 6-6 to Table 6-9 demonstrate the reduced severity of property modification factors that are expected when good quality qualification test data, prototype tests or test results from similar units are available.</p> <p><b>Table 6-6: Default lambda factors for elastomeric isolators in absence of qualification data, from ASCE 7-16 (from McVitty and Constantinou, 2015)</b></p> <table border="1" style="width: 100%; border-collapse: collapse; text-align: center;"> <thead> <tr> <th rowspan="2" style="background-color: #800000; color: white;">Lambda value</th> <th colspan="2" style="background-color: #800000; color: white;">Lead rubber</th> <th style="background-color: #800000; color: white;">Natural rubber</th> </tr> <tr> <th style="background-color: #800000; color: white;">Shear modulus G</th> <th style="background-color: #800000; color: white;">Lead yield stress <math>\bar{\delta}_l</math></th> <th style="background-color: #800000; color: white;">Shear modulus G</th> </tr> </thead> <tbody> <tr> <td style="background-color: #e0e0e0;"><math>\lambda_{ae, max}</math></td> <td>1.3</td> <td>1.0</td> <td>1.3</td> </tr> <tr> <td style="background-color: #e0e0e0;"><math>\lambda_{ae, min}</math></td> <td>1.0</td> <td>1.0</td> <td>1.0</td> </tr> <tr> <td style="background-color: #e0e0e0;"><math>\lambda_{test, max}</math></td> <td>1.3</td> <td>1.6</td> <td>1.3</td> </tr> <tr> <td style="background-color: #e0e0e0;"><math>\lambda_{test, min}</math></td> <td>0.9</td> <td>0.9</td> <td>0.9</td> </tr> <tr> <td style="background-color: #e0e0e0;"><math>\lambda_{spec, max}</math></td> <td>1.15</td> <td>1.15</td> <td>1.15</td> </tr> <tr> <td style="background-color: #e0e0e0;"><math>\lambda_{spec, min}</math></td> <td>0.85</td> <td>0.85</td> <td>0.85</td> </tr> <tr> <td style="background-color: #e0e0e0;"><math>\lambda_{max}</math></td> <td>1.83</td> <td>1.84</td> <td>1.83</td> </tr> <tr> <td style="background-color: #e0e0e0;"><math>\lambda_{min}</math></td> <td>0.60</td> <td>0.6</td> <td>0.60</td> </tr> <tr> <td style="background-color: #e0e0e0;"><b>Ratio upper/lower</b></td> <td>3.1</td> <td>3.1</td> <td>3.1</td> </tr> </tbody> </table> <p><b>Table 6-7: Comparison of ASCE 7-16 lambda factors for default and example cases for elastomeric isolators (from McVitty and Constantinou, 2015)</b></p> <table border="1" style="width: 100%; border-collapse: collapse; text-align: center;"> <thead> <tr> <th rowspan="2" style="background-color: #800000; color: white;">Case</th> <th rowspan="2" style="background-color: #800000; color: white;">Lambda values</th> <th colspan="2" style="background-color: #800000; color: white;">Lead rubber</th> <th style="background-color: #800000; color: white;">Natural rubber</th> </tr> <tr> <th style="background-color: #800000; color: white;">Shear modulus G</th> <th style="background-color: #800000; color: white;">Lead yield stress <math>\bar{\delta}_l</math></th> <th style="background-color: #800000; color: white;">Shear modulus G</th> </tr> </thead> <tbody> <tr> <td rowspan="2" style="background-color: #e0e0e0;">Default – unknown supplier and no qualification or test data</td> <td style="background-color: #e0e0e0;"><math>\lambda_{max}</math></td> <td>1.83</td> <td>1.84</td> <td>1.83</td> </tr> <tr> <td style="background-color: #e0e0e0;"><math>\lambda_{min}</math></td> <td>0.60</td> <td>0.6</td> <td>0.60</td> </tr> <tr> <td rowspan="2" style="background-color: #e0e0e0;">Based on data from similar units</td> <td style="background-color: #e0e0e0;"><math>\lambda_{max}</math></td> <td>1.61</td> <td>1.61</td> <td>1.50</td> </tr> <tr> <td style="background-color: #e0e0e0;"><math>\lambda_{min}</math></td> <td>0.85</td> <td>0.81</td> <td>0.75</td> </tr> <tr> <td rowspan="2" style="background-color: #e0e0e0;">Based on data from prototype units</td> <td style="background-color: #e0e0e0;"><math>\lambda_{max}</math></td> <td>1.61</td> <td>1.55</td> <td>1.43</td> </tr> <tr> <td style="background-color: #e0e0e0;"><math>\lambda_{min}</math></td> <td>0.85</td> <td>0.79</td> <td>0.79</td> </tr> <tr> <td rowspan="2" style="background-color: #e0e0e0;">Based on data from all production units</td> <td style="background-color: #e0e0e0;"><math>\lambda_{max}</math></td> <td>1.40</td> <td>1.35</td> <td>1.24</td> </tr> <tr> <td style="background-color: #e0e0e0;"><math>\lambda_{min}</math></td> <td>1.00</td> <td>0.93</td> <td>0.93</td> </tr> </tbody> </table>	Lambda value	Lead rubber		Natural rubber	Shear modulus G	Lead yield stress $\bar{\delta}_l$	Shear modulus G	$\lambda_{ae, max}$	1.3	1.0	1.3	$\lambda_{ae, min}$	1.0	1.0	1.0	$\lambda_{test, max}$	1.3	1.6	1.3	$\lambda_{test, min}$	0.9	0.9	0.9	$\lambda_{spec, max}$	1.15	1.15	1.15	$\lambda_{spec, min}$	0.85	0.85	0.85	$\lambda_{max}$	1.83	1.84	1.83	$\lambda_{min}$	0.60	0.6	0.60	<b>Ratio upper/lower</b>	3.1	3.1	3.1	Case	Lambda values	Lead rubber		Natural rubber	Shear modulus G	Lead yield stress $\bar{\delta}_l$	Shear modulus G	Default – unknown supplier and no qualification or test data	$\lambda_{max}$	1.83	1.84	1.83	$\lambda_{min}$	0.60	0.6	0.60	Based on data from similar units	$\lambda_{max}$	1.61	1.61	1.50	$\lambda_{min}$	0.85	0.81	0.75	Based on data from prototype units	$\lambda_{max}$	1.61	1.55	1.43	$\lambda_{min}$	0.85	0.79	0.79	Based on data from all production units	$\lambda_{max}$	1.40	1.35	1.24	$\lambda_{min}$	1.00	0.93	0.93
Lambda value	Lead rubber		Natural rubber																																																																																					
	Shear modulus G	Lead yield stress $\bar{\delta}_l$	Shear modulus G																																																																																					
$\lambda_{ae, max}$	1.3	1.0	1.3																																																																																					
$\lambda_{ae, min}$	1.0	1.0	1.0																																																																																					
$\lambda_{test, max}$	1.3	1.6	1.3																																																																																					
$\lambda_{test, min}$	0.9	0.9	0.9																																																																																					
$\lambda_{spec, max}$	1.15	1.15	1.15																																																																																					
$\lambda_{spec, min}$	0.85	0.85	0.85																																																																																					
$\lambda_{max}$	1.83	1.84	1.83																																																																																					
$\lambda_{min}$	0.60	0.6	0.60																																																																																					
<b>Ratio upper/lower</b>	3.1	3.1	3.1																																																																																					
Case	Lambda values	Lead rubber		Natural rubber																																																																																				
		Shear modulus G	Lead yield stress $\bar{\delta}_l$	Shear modulus G																																																																																				
Default – unknown supplier and no qualification or test data	$\lambda_{max}$	1.83	1.84	1.83																																																																																				
	$\lambda_{min}$	0.60	0.6	0.60																																																																																				
Based on data from similar units	$\lambda_{max}$	1.61	1.61	1.50																																																																																				
	$\lambda_{min}$	0.85	0.81	0.75																																																																																				
Based on data from prototype units	$\lambda_{max}$	1.61	1.55	1.43																																																																																				
	$\lambda_{min}$	0.85	0.79	0.79																																																																																				
Based on data from all production units	$\lambda_{max}$	1.40	1.35	1.24																																																																																				
	$\lambda_{min}$	1.00	0.93	0.93																																																																																				

Section	Commentary																																
<b>6.5</b> <i>Continued</i>	<p><b>Table 6-8: Default lambda factors for Friction Pendulum™ main sliding surface friction factor <math>\mu_1</math> in absence of qualification data, from ASCE 7-16 (from McVitty and Constantinou, 2015)</b></p> <table border="1"> <thead> <tr> <th rowspan="2">Lambda value</th> <th colspan="2">Friction Pendulum™ isolator location</th> </tr> <tr> <th>Interior</th> <th>Exterior</th> </tr> </thead> <tbody> <tr> <td><math>\lambda_{ac, max}</math></td> <td>1.56</td> <td>1.56</td> </tr> <tr> <td><math>\lambda_{ac, min}</math></td> <td>1.0</td> <td>1.0</td> </tr> <tr> <td><math>\lambda_{test, max}</math></td> <td>1.3</td> <td>1.3</td> </tr> <tr> <td><math>\lambda_{test, min}</math></td> <td>0.7</td> <td>0.7</td> </tr> <tr> <td><math>\lambda_{spec, max}</math></td> <td>1.15</td> <td>1.15</td> </tr> <tr> <td><math>\lambda_{spec, min}</math></td> <td>0.85</td> <td>0.85</td> </tr> <tr> <td><math>\lambda_{max}</math></td> <td>2.12</td> <td>2.12</td> </tr> <tr> <td><math>\lambda_{min}</math></td> <td>0.6</td> <td>0.6</td> </tr> <tr> <td>Ratio upper/lower</td> <td>3.5</td> <td>3.5</td> </tr> </tbody> </table>	Lambda value	Friction Pendulum™ isolator location		Interior	Exterior	$\lambda_{ac, max}$	1.56	1.56	$\lambda_{ac, min}$	1.0	1.0	$\lambda_{test, max}$	1.3	1.3	$\lambda_{test, min}$	0.7	0.7	$\lambda_{spec, max}$	1.15	1.15	$\lambda_{spec, min}$	0.85	0.85	$\lambda_{max}$	2.12	2.12	$\lambda_{min}$	0.6	0.6	Ratio upper/lower	3.5	3.5
	Lambda value		Friction Pendulum™ isolator location																														
Interior		Exterior																															
$\lambda_{ac, max}$	1.56	1.56																															
$\lambda_{ac, min}$	1.0	1.0																															
$\lambda_{test, max}$	1.3	1.3																															
$\lambda_{test, min}$	0.7	0.7																															
$\lambda_{spec, max}$	1.15	1.15																															
$\lambda_{spec, min}$	0.85	0.85																															
$\lambda_{max}$	2.12	2.12																															
$\lambda_{min}$	0.6	0.6																															
Ratio upper/lower	3.5	3.5																															
	<p><b>Table 6-9: Comparison of ASCE 7-16 lambda factors for default and example cases for Friction Pendulum™ isolators (from McVitty and Constantinou, 2015)</b></p> <table border="1"> <thead> <tr> <th>Case</th> <th>Lambda values</th> <th>Interior</th> <th>Exterior</th> </tr> </thead> <tbody> <tr> <td rowspan="2">Default – unknown supplier and no qualification or test data</td> <td><math>\lambda_{max}</math></td> <td>2.12</td> <td>2.12</td> </tr> <tr> <td><math>\lambda_{min}</math></td> <td>0.6</td> <td>0.6</td> </tr> <tr> <td rowspan="2">Based on data from prototype/similar units</td> <td><math>\lambda_{max}</math></td> <td>1.67</td> <td>1.39</td> </tr> <tr> <td><math>\lambda_{min}</math></td> <td>0.81</td> <td>0.58</td> </tr> <tr> <td rowspan="2">Based on data from production test units</td> <td><math>\lambda_{max}</math></td> <td>1.46</td> <td>1.2</td> </tr> <tr> <td><math>\lambda_{min}</math></td> <td>0.95</td> <td>0.68</td> </tr> </tbody> </table> <p><b>EN 15129:2009</b></p> <p>In the European standard EN 15129:2009 Anti-seismic devices, Annex J is ‘informative’ (meaning it is not mandatory) and provides upper bound lambda factors to be used for estimation of upper bound design properties (UBDP). No lower bound values are recommended.</p> <p>This standard has a factor <math>f_2</math> allowing for design temperature (an environmental factor), which will be more applicable for bridges and buildings with isolators exposed to external conditions.</p> <p>Tables J.1 to J.4 from EN 15129 are reproduced below. These give recommended lambda factors for elastomeric isolators (including lead rubber bearings) for ageing, design temperature, contamination and cumulative travel effects.</p>	Case	Lambda values	Interior	Exterior	Default – unknown supplier and no qualification or test data	$\lambda_{max}$	2.12	2.12	$\lambda_{min}$	0.6	0.6	Based on data from prototype/similar units	$\lambda_{max}$	1.67	1.39	$\lambda_{min}$	0.81	0.58	Based on data from production test units	$\lambda_{max}$	1.46	1.2	$\lambda_{min}$	0.95	0.68							
Case	Lambda values	Interior	Exterior																														
Default – unknown supplier and no qualification or test data	$\lambda_{max}$	2.12	2.12																														
	$\lambda_{min}$	0.6	0.6																														
Based on data from prototype/similar units	$\lambda_{max}$	1.67	1.39																														
	$\lambda_{min}$	0.81	0.58																														
Based on data from production test units	$\lambda_{max}$	1.46	1.2																														
	$\lambda_{min}$	0.95	0.68																														

Section	Commentary																																																																				
<b>6.5</b>  <i>Continued</i>	<p><b>Table J.1 - (<math>f_1</math> - Ageing)</b></p> <table border="1" style="width: 100%; border-collapse: collapse;"> <thead> <tr> <th rowspan="2" style="background-color: #800000; color: white;">Component</th> <th colspan="2" style="background-color: #800000; color: white;"><math>\lambda_{\max, f1}</math> for</th> </tr> <tr> <th style="background-color: #800000; color: white;"><math>K_g</math></th> <th style="background-color: #800000; color: white;"><math>F_g</math></th> </tr> </thead> <tbody> <tr> <td style="background-color: #d3d3d3;">LDRB</td> <td style="text-align: center;">1,1</td> <td style="text-align: center;">1,1</td> </tr> <tr> <td style="background-color: #d3d3d3;">HDRB1</td> <td style="text-align: center;">1,2</td> <td style="text-align: center;">1,2</td> </tr> <tr> <td style="background-color: #d3d3d3;">HDRB2</td> <td style="text-align: center;">1,3</td> <td style="text-align: center;">1,3</td> </tr> <tr> <td style="background-color: #d3d3d3;">Lead core</td> <td style="text-align: center;">-</td> <td style="text-align: center;">1,0</td> </tr> </tbody> </table> <p>with the following designations for the rubber components:</p> <p>LDRB: Low damping rubber bearing with shear modulus, at shear deformation of 100%, larger than 0.5 MPa</p> <p>HDRB 1: High damping rubber bearing with <math>\xi_{\text{eff}} \geq 0.15</math> and shear modulus, at shear deformation of 100 %. larger than 0.5 MPa</p> <p>HDRB 2: High damping rubber bearing with <math>\xi_{\text{eff}} \geq 0.15</math> and shear modulus, at shear deformation of 100 %. larger than 0.5 MPa</p> <p>Lead core: Lead core for Lead rubber bearings (LRB)</p> <p><b>Table J.2 - <math>f_2</math> - Temperature</b></p> <table border="1" style="width: 100%; border-collapse: collapse;"> <thead> <tr> <th rowspan="3" style="background-color: #800000; color: white;">Design Temperature <math>T_{\min, b}</math> (°C)</th> <th colspan="6" style="background-color: #800000; color: white;"><math>\lambda_{\max, f2}</math> for</th> </tr> <tr> <th colspan="3" style="background-color: #800000; color: white;"><math>K_g</math></th> <th colspan="3" style="background-color: #800000; color: white;"><math>F_g</math></th> </tr> <tr> <th style="background-color: #800000; color: white;">LDRB</th> <th style="background-color: #800000; color: white;">HDRB1</th> <th style="background-color: #800000; color: white;">HDRB2</th> <th style="background-color: #800000; color: white;">LDRB</th> <th style="background-color: #800000; color: white;">HDRB1</th> <th style="background-color: #800000; color: white;">HDRB2</th> </tr> </thead> <tbody> <tr> <td style="text-align: center;">20</td> <td style="text-align: center;">1.0</td> <td style="text-align: center;">1.0</td> <td style="text-align: center;">1.0</td> <td style="text-align: center;">1.0</td> <td style="text-align: center;">1.0</td> <td style="text-align: center;">1.0</td> </tr> <tr> <td style="text-align: center;">0</td> <td style="text-align: center;">1.3</td> <td style="text-align: center;">1.3</td> <td style="text-align: center;">1.3</td> <td style="text-align: center;">1.1</td> <td style="text-align: center;">1.1</td> <td style="text-align: center;">1.2</td> </tr> <tr> <td style="text-align: center;">-10</td> <td style="text-align: center;">1.4</td> <td style="text-align: center;">1.4</td> <td style="text-align: center;">1.4</td> <td style="text-align: center;">1.1</td> <td style="text-align: center;">1.2</td> <td style="text-align: center;">1.4</td> </tr> <tr> <td style="text-align: center;">-30</td> <td style="text-align: center;">1.5</td> <td style="text-align: center;">2.0</td> <td style="text-align: center;">2.5</td> <td style="text-align: center;">1.3</td> <td style="text-align: center;">1.4</td> <td style="text-align: center;">2.0</td> </tr> </tbody> </table> <p><math>T_{\min, b}</math> is the minimum isolator temperature for the seismic design situation, corresponding to the bridge location (see EN 1998-2:2005, Annex J. J.1, (2))</p> <p><b>Table J.3 - <math>f_3</math> - Contamination</b></p> <div style="border: 1px solid black; padding: 10px; text-align: center; width: fit-content; margin: 0 auto;"> <math>\lambda_{\max, f3} = 1.0</math> </div> <p><b>Table J.4 - <math>f_4</math> - Contamination</b></p> <table border="1" style="width: 100%; border-collapse: collapse;"> <tbody> <tr> <td style="background-color: #d3d3d3;">Rubber</td> <td style="text-align: center;"><math>\lambda_{\max, f4} = 1.0</math></td> </tr> <tr> <td style="background-color: #d3d3d3;">Lead core</td> <td style="text-align: center;">To be established by test</td> </tr> </tbody> </table> <p>Copies of the Tables J.5 to J.8 giving recommended lambda factors for sliding isolator devices (including lead rubber bearings) for ageing, design temperature, contamination and cumulative travel effects are shown below.</p>	Component	$\lambda_{\max, f1}$ for		$K_g$	$F_g$	LDRB	1,1	1,1	HDRB1	1,2	1,2	HDRB2	1,3	1,3	Lead core	-	1,0	Design Temperature $T_{\min, b}$ (°C)	$\lambda_{\max, f2}$ for						$K_g$			$F_g$			LDRB	HDRB1	HDRB2	LDRB	HDRB1	HDRB2	20	1.0	1.0	1.0	1.0	1.0	1.0	0	1.3	1.3	1.3	1.1	1.1	1.2	-10	1.4	1.4	1.4	1.1	1.2	1.4	-30	1.5	2.0	2.5	1.3	1.4	2.0	Rubber	$\lambda_{\max, f4} = 1.0$	Lead core	To be established by test
Component	$\lambda_{\max, f1}$ for																																																																				
	$K_g$	$F_g$																																																																			
LDRB	1,1	1,1																																																																			
HDRB1	1,2	1,2																																																																			
HDRB2	1,3	1,3																																																																			
Lead core	-	1,0																																																																			
Design Temperature $T_{\min, b}$ (°C)	$\lambda_{\max, f2}$ for																																																																				
	$K_g$			$F_g$																																																																	
	LDRB	HDRB1	HDRB2	LDRB	HDRB1	HDRB2																																																															
20	1.0	1.0	1.0	1.0	1.0	1.0																																																															
0	1.3	1.3	1.3	1.1	1.1	1.2																																																															
-10	1.4	1.4	1.4	1.1	1.2	1.4																																																															
-30	1.5	2.0	2.5	1.3	1.4	2.0																																																															
Rubber	$\lambda_{\max, f4} = 1.0$																																																																				
Lead core	To be established by test																																																																				

Section	Commentary																																																																																									
<b>6.5</b>  Continued	<p><b>Table J.5 - <math>f_1</math> - Ageing</b></p> <table border="1" style="width: 100%; border-collapse: collapse;"> <thead> <tr> <th rowspan="3" style="background-color: #800000; color: white;">Component</th> <th colspan="6" style="background-color: #800000; color: white;"><math>\lambda_{\max, f1}</math></th> </tr> <tr> <th colspan="2" style="background-color: #800000; color: white;">Unlubricated PTFE</th> <th colspan="2" style="background-color: #800000; color: white;">Lubricated PTFE</th> <th colspan="2" style="background-color: #800000; color: white;">Bimetallic Interfaces</th> </tr> <tr> <th style="background-color: #800000; color: white;">Environment</th> <th style="background-color: #800000; color: white;">Sealed</th> <th style="background-color: #800000; color: white;">Unsealed</th> <th style="background-color: #800000; color: white;">Sealed</th> <th style="background-color: #800000; color: white;">Unsealed</th> <th style="background-color: #800000; color: white;">Sealed</th> <th style="background-color: #800000; color: white;">Unsealed</th> </tr> </thead> <tbody> <tr> <td style="background-color: #d3d3d3;">Normal</td> <td>1.1</td> <td>1.2</td> <td>1.3</td> <td>1.4</td> <td>2.0</td> <td>2.2</td> </tr> <tr> <td style="background-color: #d3d3d3;">Severe</td> <td>1.2</td> <td>1.5</td> <td>1.4</td> <td>1.8</td> <td>2.2</td> <td>2.5</td> </tr> </tbody> </table> <p>The values in Table J.5 refer to the following conditions:</p> <ul style="list-style-type: none"> <li>Stainless steel sliding plates are assumed</li> <li>Unsealed conditions are assumed, to allow exposure of the sliding surfaces to water and salt</li> <li>Severe environment includes marine and industrial conditions</li> </ul> <p>Values for bimetallic interfaces apply to stainless steel and bronze interfaces.</p> <p><b>Table J.6 - <math>f_2</math> - Temperature</b></p> <table border="1" style="width: 100%; border-collapse: collapse;"> <thead> <tr> <th style="background-color: #800000; color: white;">Design Temperature</th> <th colspan="3" style="background-color: #800000; color: white;"><math>\lambda_{\max, f2}</math></th> </tr> <tr> <th style="background-color: #800000; color: white;"><math>T_{\min, t}</math> (°C)</th> <th style="background-color: #800000; color: white;">Unlubricated PTFE</th> <th style="background-color: #800000; color: white;">Lubricated PTFE</th> <th style="background-color: #800000; color: white;">Bimetallic Interfaces</th> </tr> </thead> <tbody> <tr> <td style="background-color: #d3d3d3;">20</td> <td>1.0</td> <td>1.0</td> <td rowspan="4" style="text-align: center; vertical-align: middle;">To be established by test</td> </tr> <tr> <td style="background-color: #d3d3d3;">0</td> <td>1.1</td> <td>1.3</td> </tr> <tr> <td style="background-color: #d3d3d3;">-10</td> <td>1.2</td> <td>1.5</td> </tr> <tr> <td style="background-color: #d3d3d3;">-30</td> <td>1.5</td> <td>3.0</td> </tr> </tbody> </table> <p><b>Table J.7 - <math>f_3</math> - Contamination</b></p> <table border="1" style="width: 100%; border-collapse: collapse;"> <thead> <tr> <th rowspan="2" style="background-color: #800000; color: white;">Installation</th> <th colspan="3" style="background-color: #800000; color: white;"><math>\lambda_{\max, f3}</math></th> </tr> <tr> <th style="background-color: #800000; color: white;">Unlubricated PTFE</th> <th style="background-color: #800000; color: white;">Lubricated PTFE</th> <th style="background-color: #800000; color: white;">Bimetallic Interfaces</th> </tr> </thead> <tbody> <tr> <td style="background-color: #d3d3d3;">Sealed with stainless steel surface facing down</td> <td>1.0</td> <td>1.0</td> <td>1.0</td> </tr> <tr> <td style="background-color: #d3d3d3;">Sealed with stainless steel surface facing down up</td> <td>1.1</td> <td>1.1</td> <td>1.1</td> </tr> <tr> <td style="background-color: #d3d3d3;">Unsealed with stainless steel surface facing down</td> <td>1.2</td> <td>3.0</td> <td>1.1</td> </tr> </tbody> </table> <p>The values in Table J.7 refer to the following:</p> <ul style="list-style-type: none"> <li>Sealing of bearings is assumed to offer contamination protection under all serviceability conditions</li> </ul> <p><b>Table J.8 - <math>f_4</math> - Cumulative travel</b></p> <table border="1" style="width: 100%; border-collapse: collapse;"> <thead> <tr> <th rowspan="2" style="background-color: #800000; color: white;">Cumulative Travel (km)</th> <th colspan="3" style="background-color: #800000; color: white;"><math>\lambda_{\max, f4}</math></th> </tr> <tr> <th style="background-color: #800000; color: white;">Unlubricated PTFE</th> <th style="background-color: #800000; color: white;">Lubricated PTFE</th> <th style="background-color: #800000; color: white;">Bimetallic Interfaces</th> </tr> </thead> <tbody> <tr> <td style="background-color: #d3d3d3;"><math>0.1 \leq 0.1</math></td> <td>1.0</td> <td>1.0</td> <td>To be established by test</td> </tr> <tr> <td style="background-color: #d3d3d3;"><math>1.0 &lt; \text{and} \leq 2.0</math></td> <td>1.2</td> <td>1.0</td> <td>To be established by test</td> </tr> </tbody> </table> <p>Table 6-10 shows the results of multiplying together the various EN 15129:2009 properties in a manner similar to the default values table from ASCE 7-16 shown in Figure 6-8. Although the lambda values given by EN 15129:2009 only include upper bound values, it is clear that they are much smaller than those given in ASCE 7-16 Chapter 17.</p>	Component	$\lambda_{\max, f1}$						Unlubricated PTFE		Lubricated PTFE		Bimetallic Interfaces		Environment	Sealed	Unsealed	Sealed	Unsealed	Sealed	Unsealed	Normal	1.1	1.2	1.3	1.4	2.0	2.2	Severe	1.2	1.5	1.4	1.8	2.2	2.5	Design Temperature	$\lambda_{\max, f2}$			$T_{\min, t}$ (°C)	Unlubricated PTFE	Lubricated PTFE	Bimetallic Interfaces	20	1.0	1.0	To be established by test	0	1.1	1.3	-10	1.2	1.5	-30	1.5	3.0	Installation	$\lambda_{\max, f3}$			Unlubricated PTFE	Lubricated PTFE	Bimetallic Interfaces	Sealed with stainless steel surface facing down	1.0	1.0	1.0	Sealed with stainless steel surface facing down up	1.1	1.1	1.1	Unsealed with stainless steel surface facing down	1.2	3.0	1.1	Cumulative Travel (km)	$\lambda_{\max, f4}$			Unlubricated PTFE	Lubricated PTFE	Bimetallic Interfaces	$0.1 \leq 0.1$	1.0	1.0	To be established by test	$1.0 < \text{and} \leq 2.0$	1.2	1.0	To be established by test
Component	$\lambda_{\max, f1}$																																																																																									
	Unlubricated PTFE		Lubricated PTFE		Bimetallic Interfaces																																																																																					
	Environment	Sealed	Unsealed	Sealed	Unsealed	Sealed	Unsealed																																																																																			
Normal	1.1	1.2	1.3	1.4	2.0	2.2																																																																																				
Severe	1.2	1.5	1.4	1.8	2.2	2.5																																																																																				
Design Temperature	$\lambda_{\max, f2}$																																																																																									
$T_{\min, t}$ (°C)	Unlubricated PTFE	Lubricated PTFE	Bimetallic Interfaces																																																																																							
20	1.0	1.0	To be established by test																																																																																							
0	1.1	1.3																																																																																								
-10	1.2	1.5																																																																																								
-30	1.5	3.0																																																																																								
Installation	$\lambda_{\max, f3}$																																																																																									
	Unlubricated PTFE	Lubricated PTFE	Bimetallic Interfaces																																																																																							
Sealed with stainless steel surface facing down	1.0	1.0	1.0																																																																																							
Sealed with stainless steel surface facing down up	1.1	1.1	1.1																																																																																							
Unsealed with stainless steel surface facing down	1.2	3.0	1.1																																																																																							
Cumulative Travel (km)	$\lambda_{\max, f4}$																																																																																									
	Unlubricated PTFE	Lubricated PTFE	Bimetallic Interfaces																																																																																							
$0.1 \leq 0.1$	1.0	1.0	To be established by test																																																																																							
$1.0 < \text{and} \leq 2.0$	1.2	1.0	To be established by test																																																																																							



## Section

## Commentary

## 6.5

Continued

Table 6-10: Lambda values based on EN 15129:2009

Variable	Unlubricated Interfaces	Lubricated (liquid) Interfaces	Plain low damping elastomeric	LRB	LRB	HDR <sup>1</sup>	HDR <sup>1</sup>
Symbol	$\mu$ or $Q_d$	$\mu$ or $Q_d$	K	$K_d$	$Q_d$	$K_d$	$Q_d$
<b>ELASTOMERIC ISOLATORS</b>							
$f_1$ – Aging	–	–	1.1	1.1	1.0	1.3	1.3
$f_2$ – Temperature <sup>2</sup>	–	–	1.0	1.0	1.0	1.0	1.0
$f_3$ – Contamination	–	–	1.0	1.0	1.0	1.0	1.0
$f_4$ – Cumulative travel	–	–	1.0	by test	by test	1.0	1.0
Combined effect $f_1 f_2 f_3 f_4$	–	–	1.1	1.1 <sup>3</sup>	1.0 <sup>3</sup>	1.3	1.3
<b>SLIDING ISOLATORS</b>							
$f_1$ – Aging <sup>4</sup>	1.1	1.3	–	–	–	–	–
$f_2$ – Temperature <sup>2</sup>	1.0	1.0	–	–	–	–	–
$f_3$ – Contamination <sup>5</sup>	1.0	1.0	–	–	–	–	–
$f_4$ – Cumulative travel	1.0	1.0	–	–	–	–	–
Combined effect $f_1 f_2 f_3 f_4$	1.1	1.3	–	–	–	–	–
<b>Key:</b>							
1. HDR case with $\xi_{eff} > 0.15$							
2. Temperature assumed 20 °C							
3. Total effect to include cumulative travel by test							
4. Sealed bearings							
5. Sealed with stainless steel surface facing down							

It is noted that EN 15129:2009 requires prototype ('Type') testing of two isolators, production tests on the first unit, and at least 20% of the total production units if static testing or 5% if dynamic testing.

Elastomeric bearings are primarily governed by axial load and shear strains, which are interdependent. Table 6-11 provides a recommended series of strain limits and factors of safety that can be employed in the bearing design process. These strain limits can typically be met by experienced and reputable manufacturers.

### Isolator design limits

Even if the isolator specification is limited to defining only performance requirements, it is recommended that the design engineer review the detailed bearing designs that form the isolation system during the design process. The information obtained from this review is invaluable for understanding the limitations of the isolation system due to bearing size and material limits. If a specification is compiled from such information it is likely that a supplier will be able to meet the performance requirements with little or no iteration with the design engineer, which can help reduce lead times.

Elastomeric bearings are primarily governed by axial load and shear strains, which are interdependent. Table 6-11 provides a recommended series of strain limits and factors of safety that can be employed in the bearing design process. These strain limits can typically be met by experienced and reputable manufacturers.

Section	Commentary																																
<b>6.5</b> <i>Continued</i>	<p data-bbox="328 248 1299 315"><b>Table 6-11: Typical design limits that can be applied for elastomeric isolator design checks</b></p> <table border="1" data-bbox="328 327 1420 813"> <thead> <tr> <th data-bbox="328 327 906 389">Design criterion</th> <th data-bbox="906 327 1075 389">Gravity</th> <th data-bbox="1075 327 1243 389">ULS</th> <th data-bbox="1243 327 1420 389">CALs</th> </tr> </thead> <tbody> <tr> <td data-bbox="328 389 906 465">Shear strain maximum</td> <td data-bbox="906 389 1075 465">—</td> <td data-bbox="1075 389 1243 465">200%</td> <td data-bbox="1243 389 1420 465">250%</td> </tr> <tr> <td data-bbox="328 465 906 542">Maximum compression stress (at ULS)</td> <td data-bbox="906 465 1075 542">30 MPa</td> <td data-bbox="1075 465 1243 542">30 MPa</td> <td data-bbox="1243 465 1420 542">30 MPa</td> </tr> <tr> <td data-bbox="328 542 906 618">Minimum shear strain factor of safety (F.o.S)</td> <td data-bbox="906 542 1075 618">3.0</td> <td data-bbox="1075 542 1243 618">1.5</td> <td data-bbox="1243 542 1420 618">1.25</td> </tr> <tr> <td data-bbox="328 618 906 741">Minimum buckling F.o.S</td> <td data-bbox="906 618 1075 741">3.0</td> <td data-bbox="1075 618 1243 741">1.5</td> <td data-bbox="1243 618 1420 741">1.25</td> </tr> <tr> <td data-bbox="328 741 906 813">Minimum overlap area (%)</td> <td data-bbox="906 741 1075 813">—</td> <td data-bbox="1075 741 1243 813">—</td> <td data-bbox="1243 741 1420 813">25%</td> </tr> </tbody> </table> <p data-bbox="328 855 1420 1144">Similarly, Table 6-12 indicates bearing pressure limits for friction-based isolator devices, with the intent that these values provide reliable long-term interface characteristics. These limits are highly dependent on the material being used, which is often proprietary to the isolator manufacturers. The Australian bridge design standard AS 5100.4:2004 provides contact stress limits which give a conservative bearing pressure target for design. Bridge bearing pressures are generally kept low due to the potential for significant small amplitude movements due to thermal expansion and contraction, or to vehicle braking. Over the lifetime of the bridge the sliding surfaces can accumulate thousands of metres of movement which can affect the seismic large amplitude performance, particularly if bearing pressures are sufficient to cause cold-flow of the sliding surface material. Generally, once in dialogue with an isolator supplier, more accurate data may be available for design use.</p> <p data-bbox="328 1178 1337 1245"><b>Table 6-12: Typical design limits that can be applied for sliding surface isolator bearing stress design checks</b></p> <table border="1" data-bbox="328 1256 1420 1364"> <thead> <tr> <th data-bbox="328 1256 686 1319">Type of bearing surface</th> <th data-bbox="686 1256 970 1319">Service gravity</th> <th data-bbox="970 1256 1185 1319">ULS Mean</th> <th data-bbox="1185 1256 1420 1319">ULS Peak</th> </tr> </thead> <tbody> <tr> <td data-bbox="328 1319 686 1364">PTFE</td> <td data-bbox="686 1319 970 1364">25 MPa</td> <td data-bbox="970 1319 1185 1364">50 MPa</td> <td data-bbox="1185 1319 1420 1364">60 MPa</td> </tr> </tbody> </table> <p data-bbox="328 1406 1358 1462">Note that these PTFE values are given as an example only. Different bearing stress limits would be applicable to other materials.</p>	Design criterion	Gravity	ULS	CALs	Shear strain maximum	—	200%	250%	Maximum compression stress (at ULS)	30 MPa	30 MPa	30 MPa	Minimum shear strain factor of safety (F.o.S)	3.0	1.5	1.25	Minimum buckling F.o.S	3.0	1.5	1.25	Minimum overlap area (%)	—	—	25%	Type of bearing surface	Service gravity	ULS Mean	ULS Peak	PTFE	25 MPa	50 MPa	60 MPa
Design criterion	Gravity	ULS	CALs																														
Shear strain maximum	—	200%	250%																														
Maximum compression stress (at ULS)	30 MPa	30 MPa	30 MPa																														
Minimum shear strain factor of safety (F.o.S)	3.0	1.5	1.25																														
Minimum buckling F.o.S	3.0	1.5	1.25																														
Minimum overlap area (%)	—	—	25%																														
Type of bearing surface	Service gravity	ULS Mean	ULS Peak																														
PTFE	25 MPa	50 MPa	60 MPa																														



**nzsee**  
NEW ZEALAND SOCIETY FOR  
EARTHQUAKE ENGINEERING

## 7. DETAILING AT THE ISOLATION PLANE

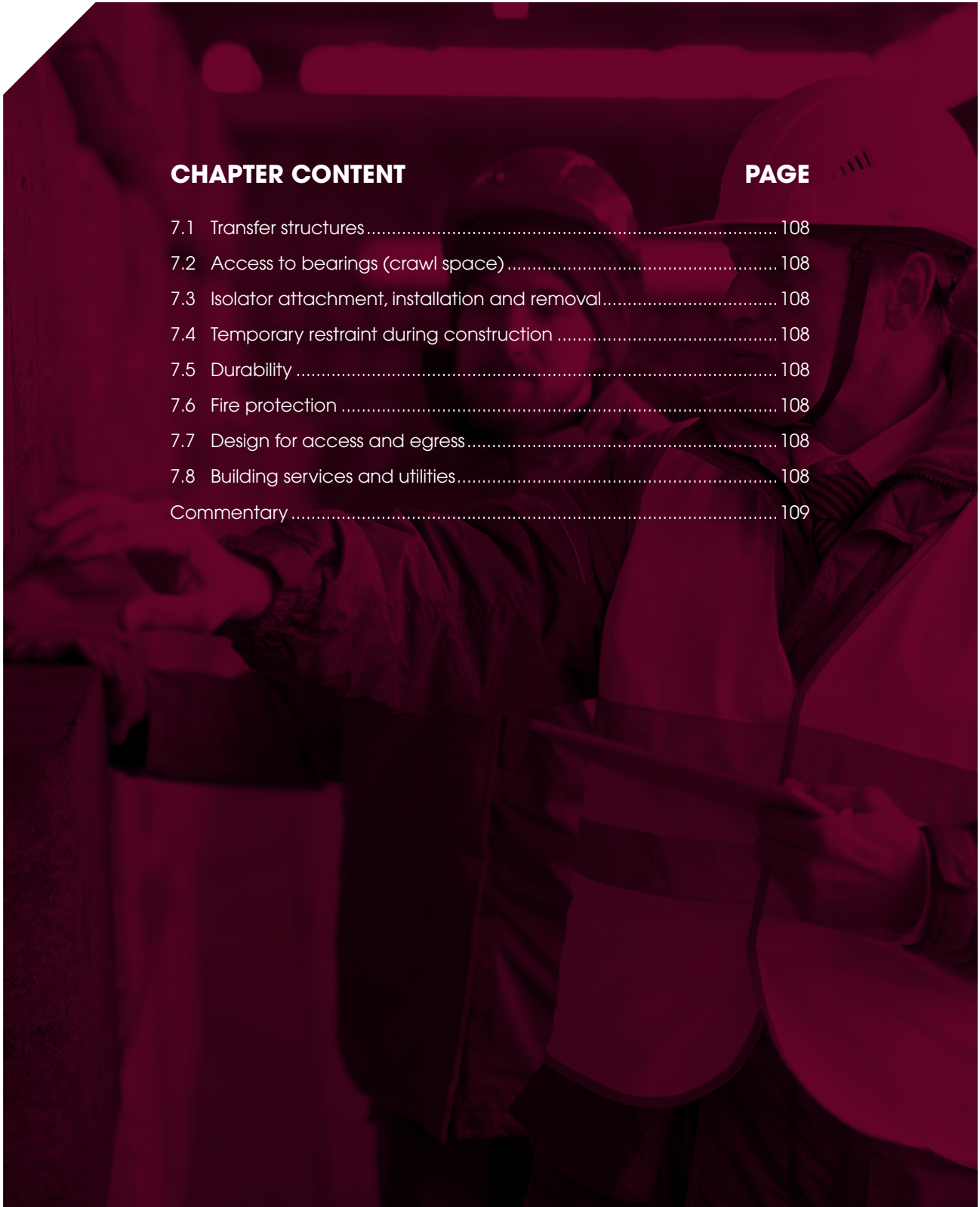

### CHAPTER CONTENT

### PAGE

7.1 Transfer structures.....	108
7.2 Access to bearings (crawl space).....	108
7.3 Isolator attachment, installation and removal.....	108
7.4 Temporary restraint during construction .....	108
7.5 Durability .....	108
7.6 Fire protection .....	108
7.7 Design for access and egress.....	108
7.8 Building services and utilities.....	108
Commentary .....	109



MINISTRY OF BUSINESS,  
INNOVATION & EMPLOYMENT  
HIKINA WHAKATUTUKI



**NZCS** | New Zealand  
Concrete Society



## 7. Detailing at the isolation plane

The isolation plane should be detailed to ensure construction, maintenance, operation during shaking, and meet the performance requirements for the isolated building.

### 7.1 Transfer structures

While isolators are normally placed under every column, the number of isolator units can be reduced with the use of transfer elements. The long-term creep of transfer structures and imposed rotations on isolators should be considered.

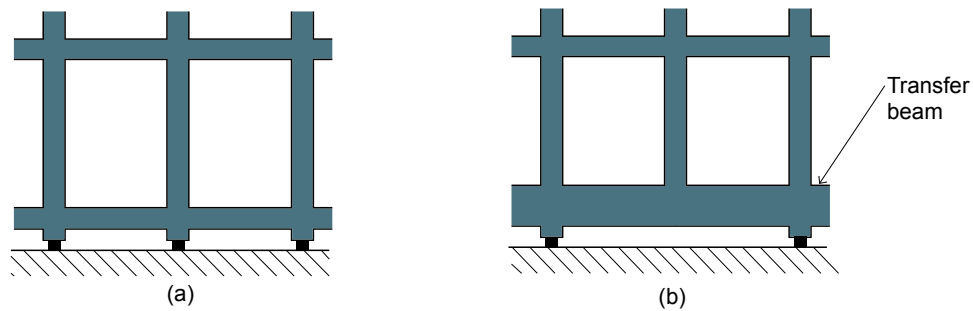

Figure 7-1: The use of transfer structures can reduce the number of bearings

### 7.2 Access to isolators (crawl space)

Safe access should be provided to space around isolators for regular inspection, maintenance and future replacement.

Design should provide for safe construction and operation as required by the Health and Safety at Work Act 2015 and should be addressed in the Safety in Design risk assessment for the building.

### 7.3 Isolator attachment, installation and removal

Attachment bolts or equivalent should be installed to allow the subsequent removal of isolators.

Installation of base isolation in existing structures should consider gravity load transfer as well as temporary stability before and after isolator installation.

### 7.4 Temporary restraint during construction

The stability of the partially complete structure during construction should be considered, including movements that could affect the contractor's temporary works.

### 7.5 Durability

Isolators and their attachments should have adequate durability to meet the relevant performance requirements of Building Code Clause B2 Durability.

### 7.6 Fire protection

Isolators and their attachments should have adequate resistance to fire to meet the relevant performance requirements of the Building Code.

### 7.7 Design for access and egress

Movement around an isolated building by the public and for construction and maintenance, as well as all access to and egress from an isolated building, should meet the relevant performance requirements of the Building Code and be addressed in the Safety in Design risk assessment.

### 7.8 Building services and utilities

Performance of building services and utilities crossing the isolation plane should be in accordance with the relevant performance requirements of the Building Code and any additional requirements agreed as part of the owner's brief.

## COMMENTARY

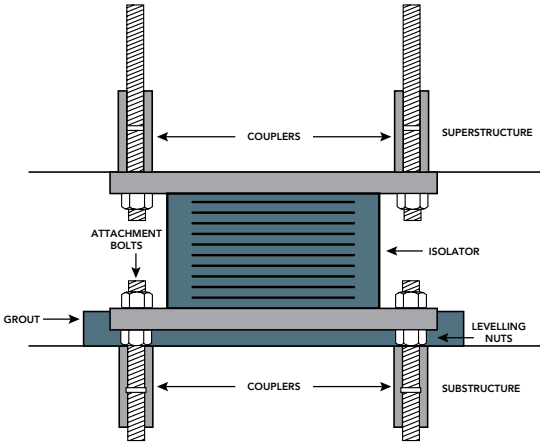
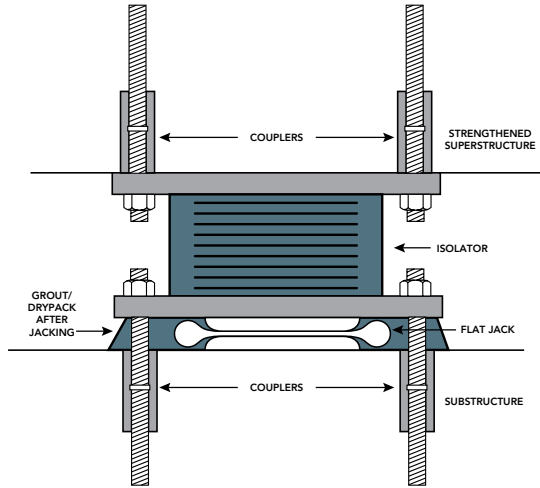
Section	Commentary
<p><b>7.2</b></p>	<p><b>Access to isolators (crawl space)</b></p> <p>This guideline recommends providing a crawl space with a minimum height of 1.2 m underneath beams protruding into that space.</p> <p>All aspects of access to isolators should comply with relevant health and safety requirements, recognising that crawl spaces may be confined spaces and require specialist equipment and training to access.</p>
<p><b>7.3</b></p>	<p><b>Isolator attachment, installation and removal</b></p> <p>A typical installation arrangement for attachment bolts is shown below.</p>  <p><i>Figure 7-2: A typical installation arrangement for attachment bolts</i></p> <p>The void between the bottom attachment plate and the structure should be fully grouted to ensure 100% coverage is obtained.</p> <p>When considering the placement of isolators under an existing structure, the gap between the isolator and the structure can be filled and the isolator vertically pre-loaded using a flat jack as shown below. The gap between the top of the attachment plate and the concrete surface is then grouted or dry packed with mortar.</p>  <p><i>Figure 7-3: Position of flat jack.</i></p> <p>Design for removal may be necessary for the following reasons:</p> <ul style="list-style-type: none"> <li>• replacement due to damage after a significant earthquake</li> <li>• degradation due to environmental effects</li> <li>• vandalism/accidental damage</li> <li>• damage due to fire exposure</li> <li>• alterations to the building above</li> </ul>

Section	Commentary
<p><b>7.3</b></p> <p><i>Continued</i></p>	<p>Structure around isolators should preferably be designed so that jacks can be positioned to support the structure while the isolator is removed. Jacks and the structure above and below them are to be designed to carry column gravity loads plus elastic resisting forces induced in the superstructure by the jacking.</p> <p>When installing isolators in existing buildings, these should generally be installed with a flat jack to ensure a known load is actively transferred onto the isolator. This load should allow for both the redistribution of the loads above the isolator and for distribution of the loads out below the isolator through the foundations. In the case of cohesive soils or redistribution of gravity loads, creep effects should be allowed for in the design and/or the pre-loading sequence.</p>
<p><b>7.4</b></p>	<p><b>Temporary restraint during construction</b></p> <p>The isolation plane will normally need to be temporarily restrained to ensure appropriate stability. Slider and pendulum isolators require temporary stabilisation when handling before installation. This is especially important when temporary shoring crosses the isolation plane. The installation process should allow for subsequent removal of all stabilisation devices.</p> <p>The building may need temporary restraint to simplify scaffolding or crane locations which cross the isolation plane. Alternatively, comprehensive checking of possible movements when constructing temporary works and access is required.</p>
<p><b>7.5</b></p>	<p><b>Durability</b></p> <p>Isolation hardware requires durability for adverse environment conditions including: ultraviolet light, salinity, acid rain and CO<sub>2</sub>, O<sub>3</sub>, industrial substances, runoff from the building, and flooding. Materials requiring consideration include: rubber, galvanised and mild steel, stainless steel and PTFE. All materials should be durable for the duration of the design life of the building.</p> <p>A comprehensive inspection and maintenance schedule should be prepared as required by Chapter 9.</p>
<p><b>7.6</b></p>	<p><b>Fire protection</b></p> <p>Fire protection is often not necessary for isolators in a non- or low-fire rated space. For all other spaces that these items are located, designers either need to show that isolators can provide vertical support during and after a fire or to provide fire resistance for the isolators equivalent to that required by adjacent gravity-bearing elements in the same region of the structure. The required fire rating of isolators should be provided in their specifications.</p> <p>The isolation system should provide vertical support for a fire immediately following an earthquake, but there is no need for full earthquake performance after fire unless this is an owner requirement.</p>
<p><b>7.7</b></p>	<p><b>Design for access and egress</b></p> <p>Consideration should be given to the possibility of the public or maintenance staff being crushed by the movement of an isolated building, including provision of personnel safety warning signs at the ends of accessible gaps between an isolated structure and adjacent walls. The Japan Society of Seismic Isolation (2013) recommends that clearance is 200 mm wider than the design displacement. If the area immediately adjacent to an isolated structure is a walkway the additional clearance should be 800 mm. Signage is recommended in both situations to warn people of the danger of the gap narrowing during an earthquake.</p> <p>Seismic movement joints pass across circulation routes, including stairs and lifts, for access and egress. Primary circulation routes, which require a higher level of seismic performance than secondary routes, should be functional during and after all seismic events. Movement joints across secondary routes and in other areas can be permitted to sustain agreed levels of damage under various limit states. Suggested levels of acceptable performance for various limit states and locations of joints are shown in Table 7-1, adapted from Saiki et al. (2013). Their survey of over 300 isolated buildings after the 2011 Tohoku earthquake revealed that 30% of the buildings experienced damage to movement joints.</p> <p>Verification methods for movement joints are also suggested in this table. Physical testing or peer review of critical movement joints is recommended.</p>

Section	Commentary																				
<p><b>7.7</b> <i>Continued</i></p>	<p>Suggested levels of acceptable damage are defined in Table 7-2, adapted from Saiki et al. (2013).                      Decisions taken regarding the performance of movement joints should be discussed and agreed to by the client. They should be described in the Design Features Report and the maintenance manual (refer Chapter 9).                      Sliding movement is usually provided at the base of stairs but can also occur mid-flight. Both the stair structure and handrails require separation. Alternatively, stairs can be integrated with and supported by a core that is connected to the superstructure and isolated from the substructure.                      The usual strategy is to fix the lift shaft to the isolated structure and suspend it so that the isolation plane passes beneath the shaft. The lift shaft needs to be braced so that it can resist horizontal inertia forces since it cantilevers from the floor above.</p>																				
<p><b>Table 7-1: Categories of movement joint minimum performance for various limit states, movement joint locations, and performance verification methods</b></p>																					
<table border="1" style="width: 100%; border-collapse: collapse;"> <thead> <tr> <th style="background-color: #800000; color: white;">Location of movement joint</th> <th style="background-color: #800000; color: white;">Maximum damage category <sup>1</sup> (DCLS)</th> <th style="background-color: #800000; color: white;">Maximum damage category at ULS</th> <th style="background-color: #800000; color: white;">Maximum damage category at CALS</th> <th style="background-color: #800000; color: white;">Suggested verification methods</th> </tr> </thead> <tbody> <tr> <td style="background-color: #d3d3d3;">Primary (evacuation) routes, high traffic people and cars</td> <td style="text-align: center;">1</td> <td style="text-align: center;">2</td> <td style="text-align: center;">3</td> <td>Dynamic movement test up to maximum design movement or peer review</td> </tr> <tr> <td style="background-color: #d3d3d3;">Secondary routes and accessible areas</td> <td style="text-align: center;">2</td> <td style="text-align: center;">3</td> <td style="text-align: center;">3</td> <td>Dynamic or a simpler movement test, or peer review</td> </tr> <tr> <td style="background-color: #d3d3d3;">Minimal access by people</td> <td style="text-align: center;">2</td> <td style="text-align: center;">3</td> <td style="text-align: center;">4</td> <td>Review of working drawings by engineer</td> </tr> </tbody> </table> <p><b>Notes:</b></p> <p>1. For damage categories refer to Table 7-2.                      2. In general for SLS1, NZS 1170.5 requires that there would be no damage requiring repair.</p>		Location of movement joint	Maximum damage category <sup>1</sup> (DCLS)	Maximum damage category at ULS	Maximum damage category at CALS	Suggested verification methods	Primary (evacuation) routes, high traffic people and cars	1	2	3	Dynamic movement test up to maximum design movement or peer review	Secondary routes and accessible areas	2	3	3	Dynamic or a simpler movement test, or peer review	Minimal access by people	2	3	4	Review of working drawings by engineer
Location of movement joint	Maximum damage category <sup>1</sup> (DCLS)	Maximum damage category at ULS	Maximum damage category at CALS	Suggested verification methods																	
Primary (evacuation) routes, high traffic people and cars	1	2	3	Dynamic movement test up to maximum design movement or peer review																	
Secondary routes and accessible areas	2	3	3	Dynamic or a simpler movement test, or peer review																	
Minimal access by people	2	3	4	Review of working drawings by engineer																	
<p><b>Table 7-2: Definition of categories of damage to movement joints</b></p>																					
<table border="1" style="width: 100%; border-collapse: collapse;"> <thead> <tr> <th style="background-color: #800000; color: white;">Damage category</th> <th style="background-color: #800000; color: white;">Performance description</th> </tr> </thead> <tbody> <tr> <td style="text-align: center;">1</td> <td>No deformation, change of slope or opening of a gap that affects functionality. The joint can be used continuously without repair. Minor damage such as scratches to finishes or cuts to seals are acceptable.</td> </tr> <tr> <td style="text-align: center;">2</td> <td>Minor and readily repairable damage due to deformation, change of slope or gaps. Some adjustments and repairs may be required but primary functionality is maintained. All areas are accessible even though there may be some differences in level or protrusion of wall elements. Damage does not impede the movement gap.</td> </tr> <tr> <td style="text-align: center;">3</td> <td>Significant damage affects but does not prevent function. Large scale repair or replacement of joints is necessary, but no elements are detached making some floor areas inaccessible. Damage does not impede the movement gap.</td> </tr> <tr> <td style="text-align: center;">4</td> <td>Major damage leading to loss of function. Continuous use immediately after an earthquake is not possible. Damage does not impede the movement gap.</td> </tr> </tbody> </table>		Damage category	Performance description	1	No deformation, change of slope or opening of a gap that affects functionality. The joint can be used continuously without repair. Minor damage such as scratches to finishes or cuts to seals are acceptable.	2	Minor and readily repairable damage due to deformation, change of slope or gaps. Some adjustments and repairs may be required but primary functionality is maintained. All areas are accessible even though there may be some differences in level or protrusion of wall elements. Damage does not impede the movement gap.	3	Significant damage affects but does not prevent function. Large scale repair or replacement of joints is necessary, but no elements are detached making some floor areas inaccessible. Damage does not impede the movement gap.	4	Major damage leading to loss of function. Continuous use immediately after an earthquake is not possible. Damage does not impede the movement gap.										
Damage category	Performance description																				
1	No deformation, change of slope or opening of a gap that affects functionality. The joint can be used continuously without repair. Minor damage such as scratches to finishes or cuts to seals are acceptable.																				
2	Minor and readily repairable damage due to deformation, change of slope or gaps. Some adjustments and repairs may be required but primary functionality is maintained. All areas are accessible even though there may be some differences in level or protrusion of wall elements. Damage does not impede the movement gap.																				
3	Significant damage affects but does not prevent function. Large scale repair or replacement of joints is necessary, but no elements are detached making some floor areas inaccessible. Damage does not impede the movement gap.																				
4	Major damage leading to loss of function. Continuous use immediately after an earthquake is not possible. Damage does not impede the movement gap.																				

Section	Commentary
---------	------------

**7.7**

*Continued*

**Stairs**

Detailing for movement is necessary wherever stairs cross an isolation plane.

Stairs will generally be part of the primary egress route from a building and should be designed accordingly to provide performance in accordance with Table 7-1 and Table 7-2.

**Lifts**

Lifts should not be part of the primary egress route from a building. Lifts should achieve performance required for secondary egress and accessible areas.

Isolation planes should be designed to pass under lift shafts as shown in Figure 7-4.

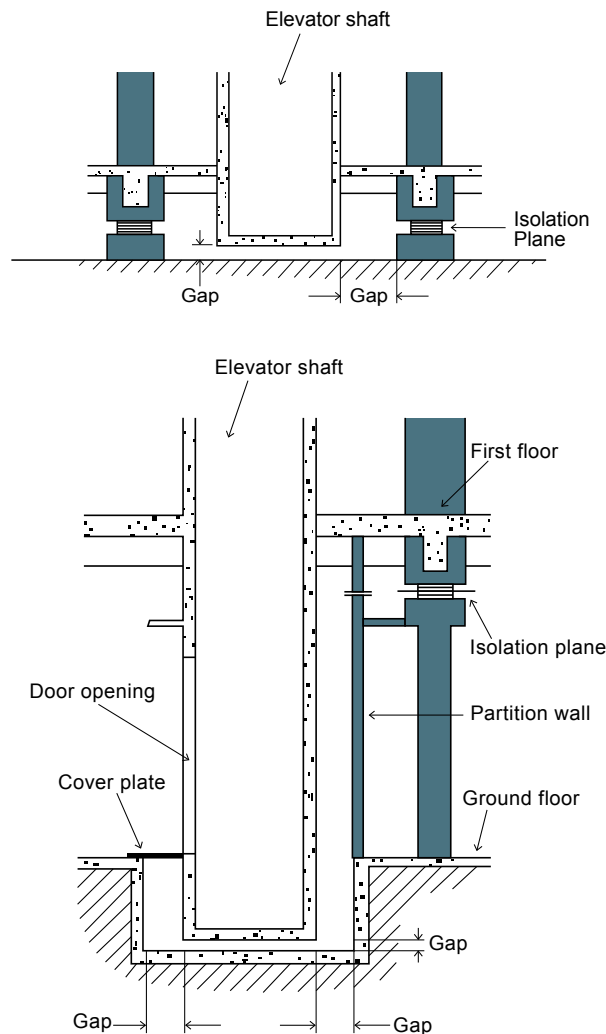

*Figure 7-4: Sections through a lift shaft showing how it hangs from the superstructure and is braced back to it. Also showing seismic gaps.*

Note in Figure 7-4 the elevator shaft is separated from any other elements that might prevent its movement with the isolated superstructure. In upper diagram, the isolation plane is at the base of the building, while in the lower diagram the isolation plane is near mid-storey height.

**Movement joint covers**

A moat or rattle space cover can consist of a cantilever slab, a hinged slab or a steel plate. It usually connects to the isolated structure and cantilevers over or rests on the top of the retaining wall, simply sliding along it and over it (Figure 7-5 and Figure 7-6). Its role is to protect people from the gap and to prevent a build-up of debris, snow, ice, vegetation, sacrificial building items, or any other matter or object blocking the movement gap.



Section	Commentary
---------	------------

**7.7**

Continued

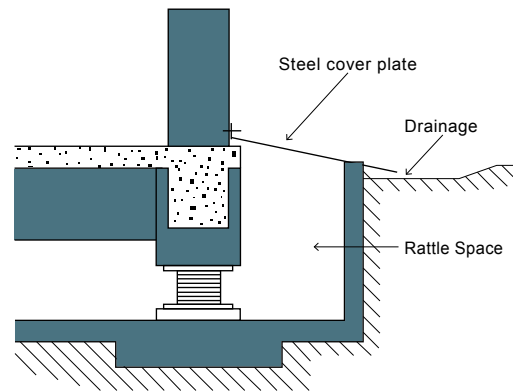

*Figure 7-5: A section showing a steel cover plate connected to the isolated structure*

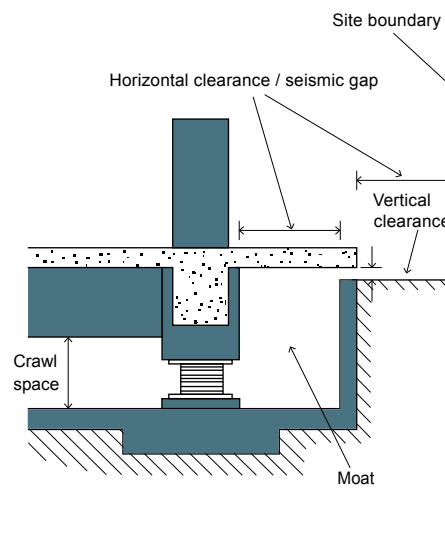

*Figure 7-6: A cantilever slab covering the rattle space and the necessary clearances*

Note in Figure 7-6 that this plate can slide on the retaining wall beneath it, limiting damage to the extent required by Table 7-1 and Table 7-2.

Where moat covers or movement joints abut exterior paving at the same level, a typical detail employs angled sliding surfaces to prevent compression occurring in the cover plate when the building moves towards the paving (Figure 7-7). This detail is unsuitable where the maximum allowable damage to a movement joint is damage category 1 from Table 7-2.

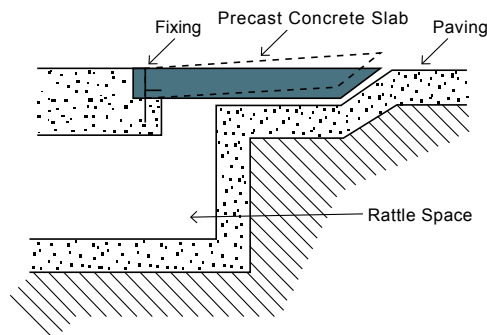

*Figure 7-7: A moat covered by a precast concrete slab*

Examples of cover plates for floors, both exterior and interior, are shown in Figure 7-8. In some situations, movement joints will need to be fire-rated, possibly by using fire blankets. Cover plates over movement joints in walls and ceilings may also be required.

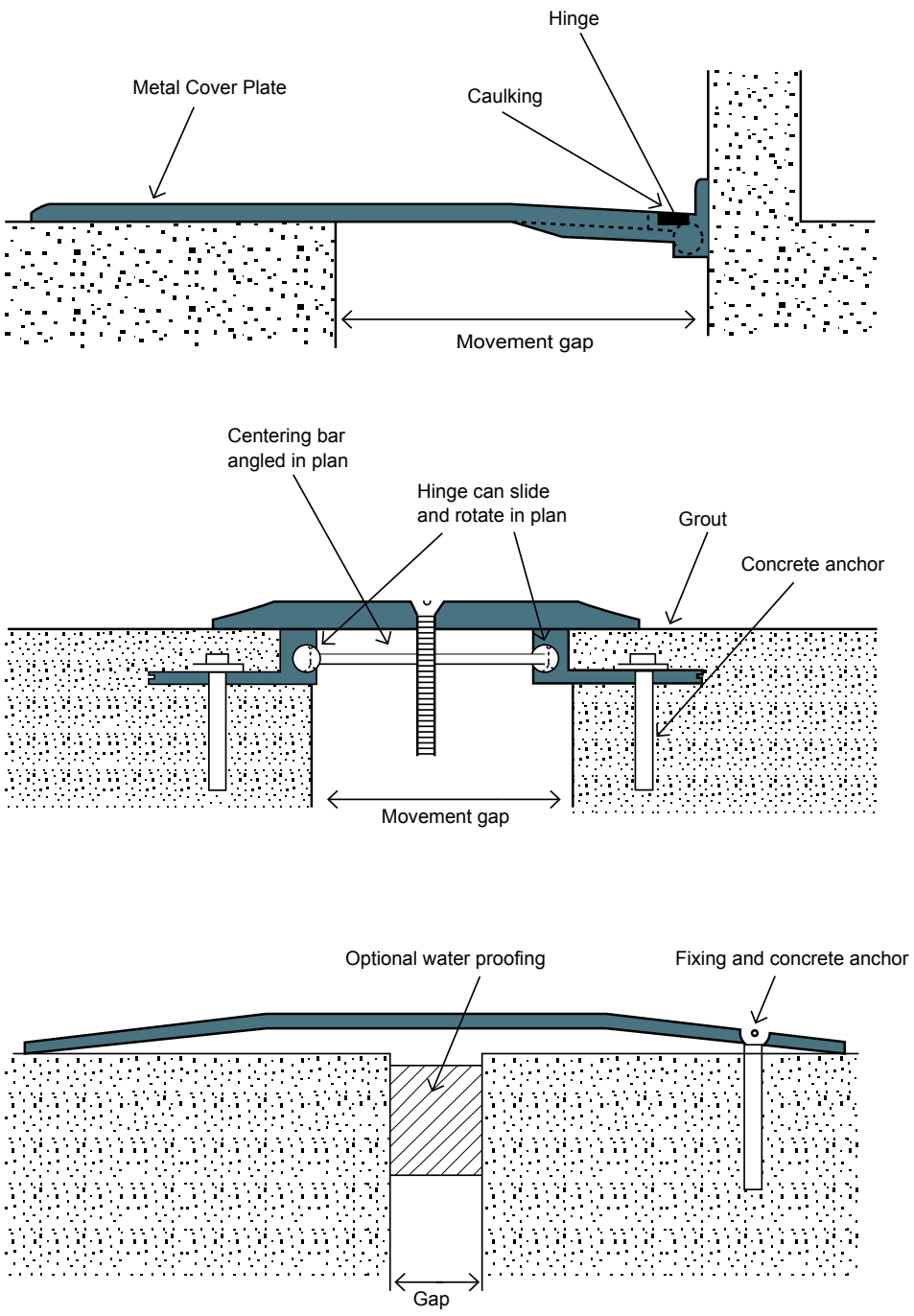
Section	Commentary
<p><b>7.7</b> Continued</p>	 <p>The figure consists of three cross-sectional diagrams illustrating different methods for detailing floor cover plates at a movement joint.       1. The top diagram shows a metal cover plate extending across a joint. On the right side, the plate is secured with a hinge and caulking. A horizontal double-headed arrow below the joint indicates the 'Movement gap'.       2. The middle diagram shows a more complex assembly. A 'Centering bar angled in plan' is positioned across the joint. A 'Hinge can slide and rotate in plan' is located on top of the cover plate. The assembly is supported by 'Grout' and 'Concrete anchors' on both sides. A 'Movement gap' is indicated by a horizontal double-headed arrow.       3. The bottom diagram shows a cover plate with 'Optional water proofing' on the left side and a 'Fixing and concrete anchor' on the right side. A 'Gap' is indicated by a horizontal double-headed arrow at the bottom of the joint.</p> <p><i>Figure 7-8: Three generic types of cover plates for floors that allow horizontal movement in any direction. Fire blankets and other necessary construction details are not shown.</i></p> <p>While allowing for inwards and outwards movement in the plane of a wall that crosses a movement joint is straightforward, displacements normal to the walls are far more difficult to achieve while simultaneously coping with wind pressure and other weatherproofing requirements. One approach is to specify a proprietary system that has suitable proven performance or to specify the performance requirements that a product is to meet (Figure 7-9).</p> <p>For more information about movement joints refer to Charleson and Guisasola (2017).</p>

Section	Commentary
<p><b>7.7</b></p> <p><i>Continued</i></p>	<div data-bbox="545 295 1217 889" data-label="Image"> </div> <p data-bbox="400 916 1347 945"><i>Figure 7-9: A wall movement joint that allows movement in both horizontal directions</i></p> <p data-bbox="336 987 544 1016"><b>Sacrificial zones</b></p> <p data-bbox="336 1028 1398 1142">Small movements may be allowed for by minimal movement provision and by deformation of wall linings and some members designed to be sacrificial in a large event, like light-gauge steel flashings and frangible lining panels. Ensure that no services systems are contained in crush areas and that any consequential damage will not block the movement joint.</p> <p data-bbox="336 1153 1382 1238">The likelihood of damage to these sacrificial zones under even moderate earthquake shaking should be considered with the intended performance level and be communicated to and agreed with the owner.</p>
<p><b>7.8</b></p>	<p data-bbox="336 1290 823 1323"><b>Building services and utilities</b></p> <p data-bbox="336 1341 1382 1485">The challenge of designing movement joints that meet performance objectives acceptable to the client should not be underestimated. It is likely that several iterations of design development will be required. Designers should consider constructing small physical models both to develop the design and to help communicate it – possibly to the client, but definitely to the contractor. Assume that a contractor has never had to allow for such large seismic movements before.</p> <p data-bbox="336 1516 440 1545"><b>General</b></p> <p data-bbox="336 1554 1410 1668">All services need to be evaluated both for the risk to life and property they pose if damaged and for their roles in keeping the building functional after an earthquake to the extent required. Given their potential vulnerability to liquefaction and other geohazards remote from the site, the overall reliability of services systems should be considered.</p> <p data-bbox="336 1700 679 1729"><b>Piped and ducted services</b></p> <p data-bbox="336 1738 1382 1823">Pipes and ducts crossing a movement joint or isolation plane need to be flexible, pin jointed, or connected with flexible connections to achieve the required performance at the various limit states (Figure 7-10).</p> <p data-bbox="336 1834 1394 1948">High risk items need to accommodate CALS displacement without damage, while lesser risk services should remain functional at the limit states agreed to by the client. The consequences of damage and reparability should also be considered; as should the performance of services, such as storm water drainage, under residual displacements.</p>

Section	Commentary
---------	------------

**7.8**

Continued

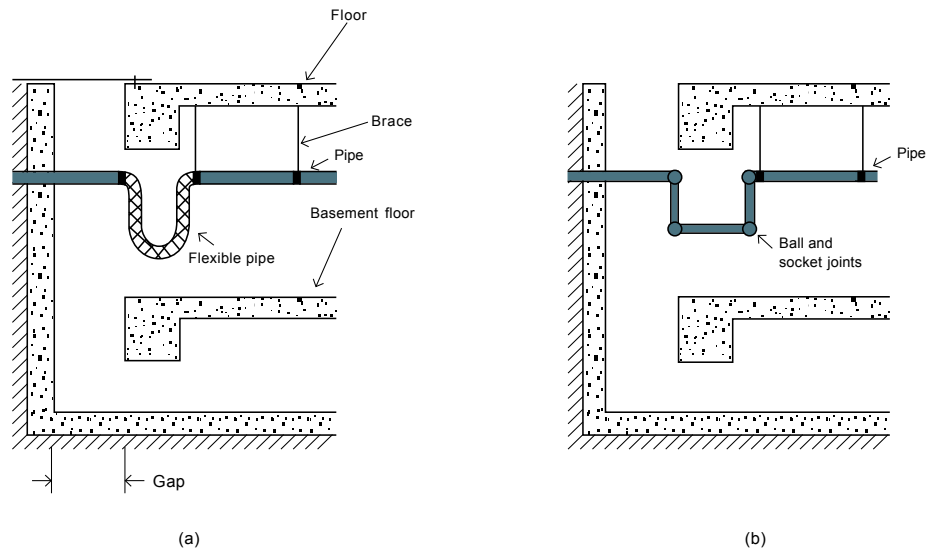

*Figure 7-10: Methods for achieving flexible connections for the design displacements between the isolated superstructure and fixed elements like retaining walls*

**Electrical cabling**

Additional cable length to accommodate the design displacement across the isolation plane is necessary. Cable loops can provide this capability. Barriers may be required to prevent vandalism.

**Other building fabric**

Designers should check that other aspects necessary for building functionality (such as fire protection, weather and acoustic proofing) perform as intended after movement joints are displaced; especially if there are any residual offsets. The performance of each of these aspects including reparability needs to be assessed for each appropriate limit state, and decisions made in conjunction with the client regarding the levels of protection adopted.

Designers should be aware of the degree of difficulty and complexity in providing separation between services and other elements, such as ceilings, that hang from isolated structure above and require complete separation from other building elements, like partition walls below, that are not isolated (Figure 7-11). Particular attention needs to be paid to such detailing both during design and construction.

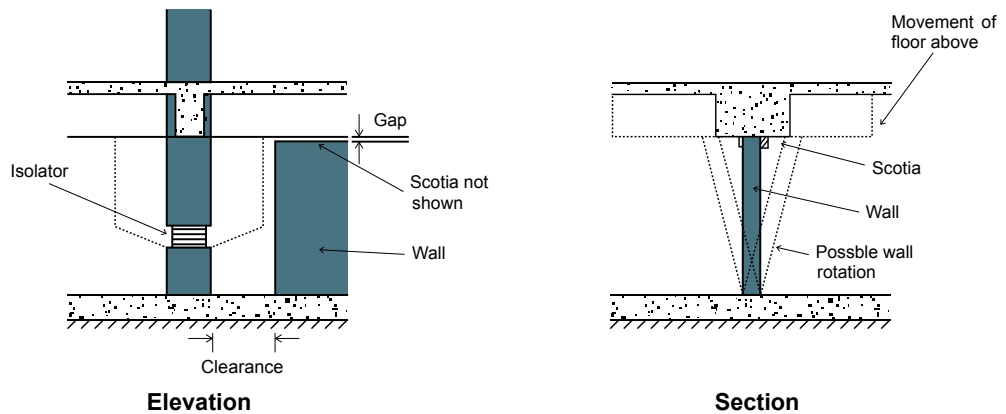
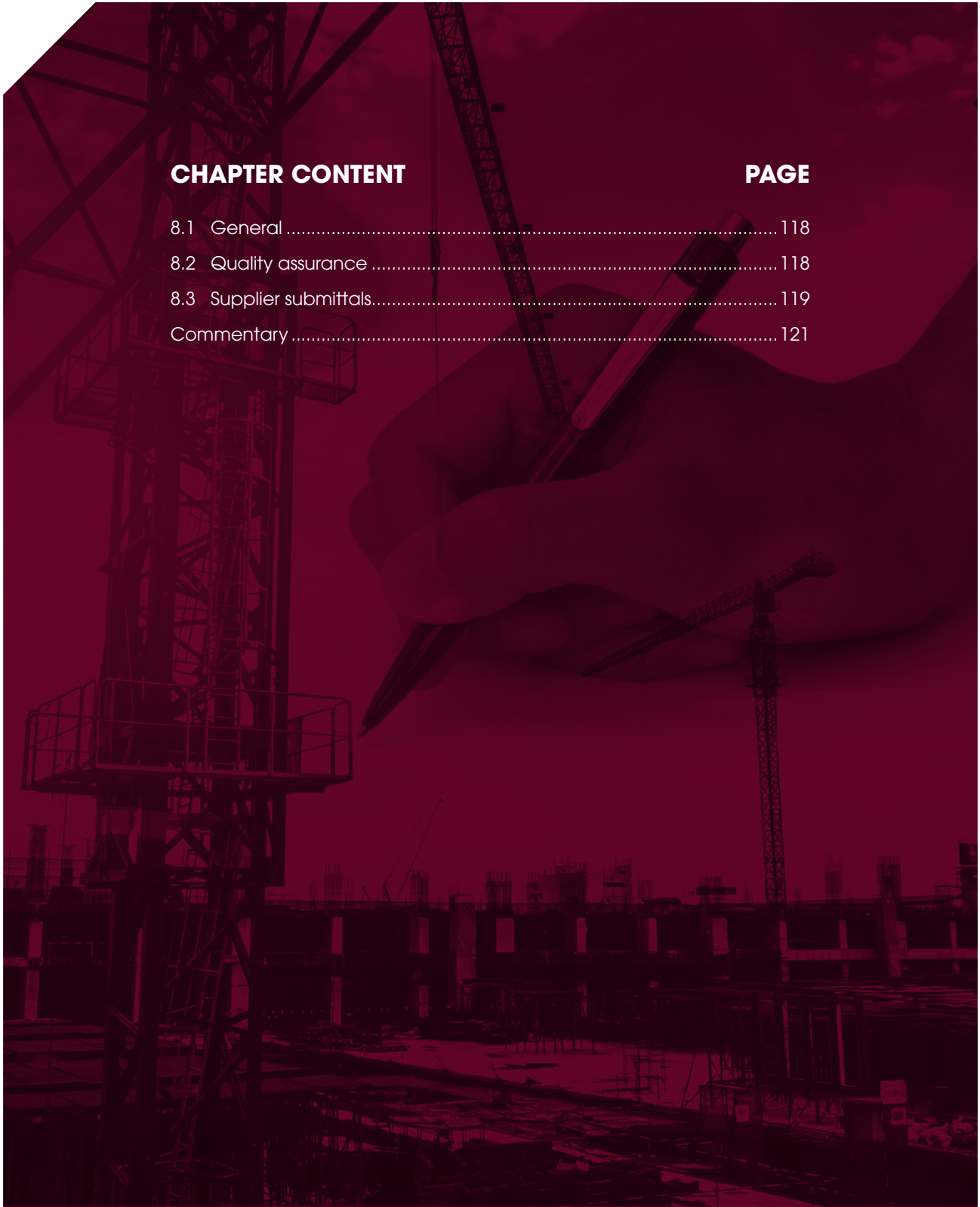

*Figure 7-11: Separation of a partition wall below the isolation plane from the isolated structure above*



**nzsee**  
NEW ZEALAND SOCIETY FOR  
EARTHQUAKE ENGINEERING

## 8. SPECIFICATION FOR PROCUREMENT OF ISOLATION SYSTEMS AND ISOLATORS



<b>CHAPTER CONTENT</b>	<b>PAGE</b>
8.1 General .....	118
8.2 Quality assurance .....	118
8.3 Supplier submittals.....	119
Commentary .....	121



MINISTRY OF BUSINESS,  
INNOVATION & EMPLOYMENT  
HIKINA WHAKATUTUKI



**NZCS** | New Zealand  
Concrete Society



**Quake Centre**  
Engineering Industry Solutions

## 8.1 General

A technical specification should be prepared for inclusion in the isolation system supply contract. This may be a standalone contract or form part of an overall building construction contract under a main contractor. A sample document is provided in Appendix C.

The specification should clearly state which party is responsible for the design of the isolation system and isolators for the purposes of contractual obligations and also for building work (engineering design) under the Building Code.

The technical specification should set out the specific types of isolators required and performance requirements such as loads and displacements that these isolators should be designed, manufactured, tested, certified, supplied and installed in accordance with.

Isolation systems and isolators should be supplied in accordance with an approved Standard, code of practice or supplier specification.

The technical specifications or performance brief provided for procurement of an isolation system and isolators should clearly set out the requirements to be met by the supplier that will be:

- consistent with the requirements of the design and project-specific requirements, including testing
- compliant with the requirements of the Building Code and building consent, and
- compliant with the terms and conditions of the supply contract.

The design documentation and specification should make it clear who is responsible for designing and who is responsible for supplying hardware for attaching the isolators to the structure above and below the isolation plane, including anchor bolts, any required interfacing/adaptor plates and embedments in the structure.

The specification should describe the number and type of isolators required for project installation as well as the prototype isolators (not to be used in the building) and additional spare isolators to be supplied.

## 8.2 Quality assurance

### 8.2.1 Records and testing

The design engineer should be satisfied that the supplier has an adequate track record of supplying the type of isolation systems and isolators that should meet the specified performance criteria.

The supplier of the isolation system and isolators should be required to ensure that the supplied isolators, including design, materials, manufacture, testing and documentation, comply with the specified criteria and performance requirements.

Quality assurance (QA) and quality control (QC) procedures should be provided as part of any supplier tender submission and submitted for the approval of the engineer.

Supplier qualification records should be provided as part of pre-qualifying suppliers to demonstrate their track record and capability (refer to Section 8.3 below).

Prototype testing should be completed on at least two units for each type and size of isolator required. Previous tests of identical or sufficiently similar isolators may be considered as acceptable by the design engineer, typically if the key design and performance parameters are within 20% of those specified.

The design engineer can either develop and define a specific prototype test programme, or refer to EN 15129: 2009 or ASCE 7-16 which provide detailed requirements for testing both elastomeric and sliding surface isolators. The design engineer may prefer to use one of these Standards as a baseline specification to which they amend testing requirements as appropriate. The total required testing programme should be clearly identified and communicated in the specification document provided to suppliers.

A key component of prototype testing is to identify the influence of velocity on the characteristics of isolators, which can have significant impacts on the isolation system behaviour.

The specification should clearly state what production QC testing is to be carried out on production units and to what Standard and the acceptance criteria.

The specification should state whether testing is to be carried out by a testing agency commercially independent of the supplier, engaged either by the supplier or another party.

## 8.2.2 Independent engineering verification

The specification should require that the supplier engages a suitably qualified independent engineer with experience in isolation design and testing methods or requirements, to oversee and verify the manufacture and testing of the isolators and to provide suitable certification that these have been supplied in accordance with the specification.

The design engineer should review the experience and credentials of the independent engineer if they themselves are not present for the testing.

The design engineer should consider what further level of monitoring of supplier activities is deemed necessary as part of their engagement to the employer and their professional obligations. The design engineer or a third party observer may be engaged (normally by the owner or engineer) to monitor the supplier and independent engineering verification at each relevant stage of the manufacture and testing to ensure that the work complies with the contract documents and technical specification.

## 8.2.3 Producer Statements

The supply specifications should clearly state who is responsible for providing Producer Statements (PS1 – Design and PS3 – Construction) and in what form so they will be suitable for submission to the Building Consent Authority for the purposes of obtaining a building consent and, once construction is completed, a code compliance certificate.

Producer Statements will need to be signed by suitably experienced and qualified persons. The supplier should acknowledge their undertaking to provide the required Producer Statements and the reliance that will be placed on them.

## 8.2.4 Warranty

A warranty should be obtained from the supplier that warrants the isolation system and isolator performance is in accordance with the technical specification, approved Standards and requirements of the Building Code.

# 8.3 Supplier submittals

## 8.3.1 Pre-qualification submittals

Suppliers wishing to pre-qualify to supply isolation systems or isolators should provide:

- their track record of previous similar projects undertaken
- qualification records for isolators similar to those required
- other requested commercial information about their business and their viability and ability to undertake the project.

## 8.3.2 Tender submittals

In addition to the submittals outlined in the 'Preliminary and General' section of the tender specification, suppliers should include the following type of information for review and approval by the engineer (design engineer or engineer to the contract):

- qualification records relevant to the isolators proposed for the project
- design Standard and design criteria to be used for the design of the isolators
- preliminary design and performance details for each type of isolator and for the isolation system as a whole
- quality assurance plan
- proposed prototype testing
- proposed production QC testing
- proposed Producer Statements and signatories
- proposed form of warranty (in accordance with requirements of the contract).

### 8.3.3 Manufacture and supply phase submittals

The supplier should provide the following information for the engineer's approval:

- detailed design documents including design calculations and material specifications for each type and size of isolator
- shop drawings showing size of each type of isolator and mounting plates, including bolting configurations
- prototype test reports demonstrating compliance with the specification
- production test reports demonstrating compliance with the specification
- completed quality assurance reporting
- Producer Statements and associated supporting documentation
- installation, inspection and maintenance manuals including methods for replacement of isolators
- completed warranty forms.



# COMMENTARY

Section	Commentary
8.1	<p><b>General</b></p> <p>Suggested technical content for the supply specification document for procurement of specific isolation systems and isolators is included in Appendix C of this guideline. This material should be considered carefully for completeness and suitability and will need to be edited appropriately.</p> <p>Specification for supply of isolation systems and isolators should follow the recommendations in this guideline and be consistent with the building and isolation system design, as well as with the requirements of New Zealand Building Code and cited Standards for design, manufacture, and testing of isolation systems and isolators.</p> <p>It is recommended that responsibility for design of isolators is passed to the supplier, as they will generally have the most appropriate experience.</p> <p>The preferred method for specifying isolation systems or isolators is for the design engineer to carry out the global system design and select the required types of isolator and to state the performance requirements (generally load and displacement combinations) that the individual bearings are to be designed for. The supplier will then carry out detailed design of the isolators, followed by manufacture, testing and providing required certification in accordance with the technical specification and approved Standard. This approach may allow pre-engineered and tested isolators from a supplier to be used.</p> <p>A second, but less preferred, method is for an overall system performance specification to be provided, allowing suppliers to select the types of isolators to be designed and supplied by them. The design engineer would need to specify the isolator locations, vertical loads and assumed overall system behaviour and other design criteria and assumptions. Significant interaction and design iteration may be required between the design engineer and supplier in order to finalise the design of the system and agree final device characteristics.</p> <p>A third and least recommended method is for the designer to fully design and specify the isolators and provide a prescriptive supply specification for these. This approach should only be used by suitably experienced design engineers.</p> <p>Overall responsibility for design and performance of the building and isolation system will remain with the design engineer.</p> <p>Other approaches to specifying isolation systems and isolators may be possible, for example if working collaboratively with a supplier.</p> <p>Where supplier proposed alternatives are permitted, the specification needs to be clear in communicating which party is responsible for design and how acceptance criteria for the alternatives will be established.</p> <p>Relevant international codes which design engineers should refer to include the European standard EN 15129 Anti-seismic Devices or the US standard ASCE 7-16 (Section 17). This guidance document refers to aspects of EN 15129 for testing and verification: for simplicity, the engineer may choose to adopt the requirements of that recognised code.</p> <p><b>System performance specification</b></p> <p>Where a global system performance specification is provided to the supplier, the specification should set out the overall performance design assumptions for the isolation system used by the design engineer. The key information supplied will be the definition of isolation plane force-displacement characteristics, hysteretic loop area (and equivalent viscous damping) at ULS and CALS limit states.</p> <p><b>Isolator performance variability</b></p> <p>Both ASCE 7-16 and EN 15129:2009 provide information on acceptable bounds for the effective stiffness and yield force of isolators. Generally, it is acceptable to allow some deviation above and below the target specified values. It is suggested that the <math>\pm 15\%</math> bounds provided in the Eurocode are acceptable for individual units, but for the average effect across the whole isolation plane the tighter constraints, such as <math>\pm 5\%</math>, would be appropriate. Reputable manufacturers with significant experience should generally not find these variability limits too onerous. Often, suppliers will have previous isolator designs with proven performance that may be put forward if their characteristics fall within permitted limits.</p> <p>While the basic device parameters such as yield level and post-yield stiffness provided in the specification generally dictate overall hysteretic properties, there can be considerable variation in hysteretic loop shape and enclosed area. Design engineers and suppliers should carefully consider the behaviour of previous similar isolators to ensure that acceptance criteria will be met.</p>

Section	Commentary
<p><b>8.2</b></p>	<p><b>Quality assurance</b></p> <p>Quality assurance procedures for confirming the adequacy of isolators is critical. QA processes will normally be in two stages:</p> <ul style="list-style-type: none"> <li>• first, during tendering or pre-contract award covering supplier qualification and proposed testing</li> <li>• second, after award of the supply contract covering detailed submissions such as full design details, shop drawings, prototype and production testing results.</li> </ul> <p>The requirements for prototype and production testing are well covered in EN 15129 for isolator types covered by this guideline. Refer to this document for specific information around which the system and isolator specification can be developed.</p> <p>For testing of production units, EN 15129 provides guidance on the minimum number of units (as low as 20%). It is noted that international practice is variable; for example, ASCE 7-16 requires physical load testing of 100% of production units. The design engineer will need to consider and specify how many units are required to be tested. A conservative default approach would be to require 100% of production units to be tested under combined compression and shear load, especially if the supplier does not provide extensive track record and pre-qualification test records.</p> <p>In considering the number of units to be tested it would be prudent to consider the following:</p> <ul style="list-style-type: none"> <li>• the extent to which variability in isolator behaviour could affect the overall system performance</li> <li>• consequences of variability</li> <li>• supplier track record</li> <li>• applicability of supplier qualifications, and</li> <li>• prototype test data.</li> </ul> <p>Prototype testing can be specified to be carried out by an independent testing facility rather than by the supplier. Alternatively, the supplier may be able to carry out prototype testing to the satisfaction of the engineer.</p> <p>Production QC testing shall be completed on an agreed number of production units. The requirement for the number of units to be tested will depend on a number of things including supplier experience and demonstration of consistency from previous projects, the manufacturing process and whether units are made from different material batches, or what QC is undertaken on the constituent materials during the production process. The number of units in the project is also a key variable, with small projects and limited number of bearings tending to require a greater percentage to be QC tested due to the impact on performance if a few units were not to meet the specifications. EN 15129:2009 and ASCE7-16 provide guidance on parameters to be addressed through QC testing.</p>
<p><b>8.3</b></p>	<p><b>Supplier submittals</b></p> <p>Supplier qualification records should include specifications and testing records of all relevant similar isolators previously supplied. As not many global suppliers have supplied to New Zealand before, it is important to establish a measure of confidence and security for the client in selecting a supplier. This information can also help to identify possible issues that may affect particular products or their suitability for a project.</p> <p>Prototype testing is a fundamental requirement to arriving at a satisfactory isolation system, in which the design engineer can have access to sufficient information to establish that performance design targets will be met. Prototypes may be selected from previously manufactured isolators or from a manufacturer's catalogue, if they have been fully tested as required.</p> <p>Lead times for the supply of isolators can be significant, particularly when new prototype testing is required. The programme required for design, testing, manufacture and supply of prototype and production units should be established and agreed with the main contractor to meet the overall project programme.</p> <p>Satisfactory prototype testing should be completed and approved before manufacture of production units begins.</p> <p>The supplier should also be requested to provide device-specific recommendations for maintenance and periodic inspection.</p>



**nzsee**  
NEW ZEALAND SOCIETY FOR  
EARTHQUAKE ENGINEERING

## 9. INSPECTION AND MAINTENANCE

### CHAPTER CONTENT

### PAGE

9.1 General .....	124
9.2 Warning signage .....	124
9.3 Maintenance manual .....	124
9.4 Displacement recorders.....	124
9.5 Inspection and maintenance programme.....	124
Commentary .....	126

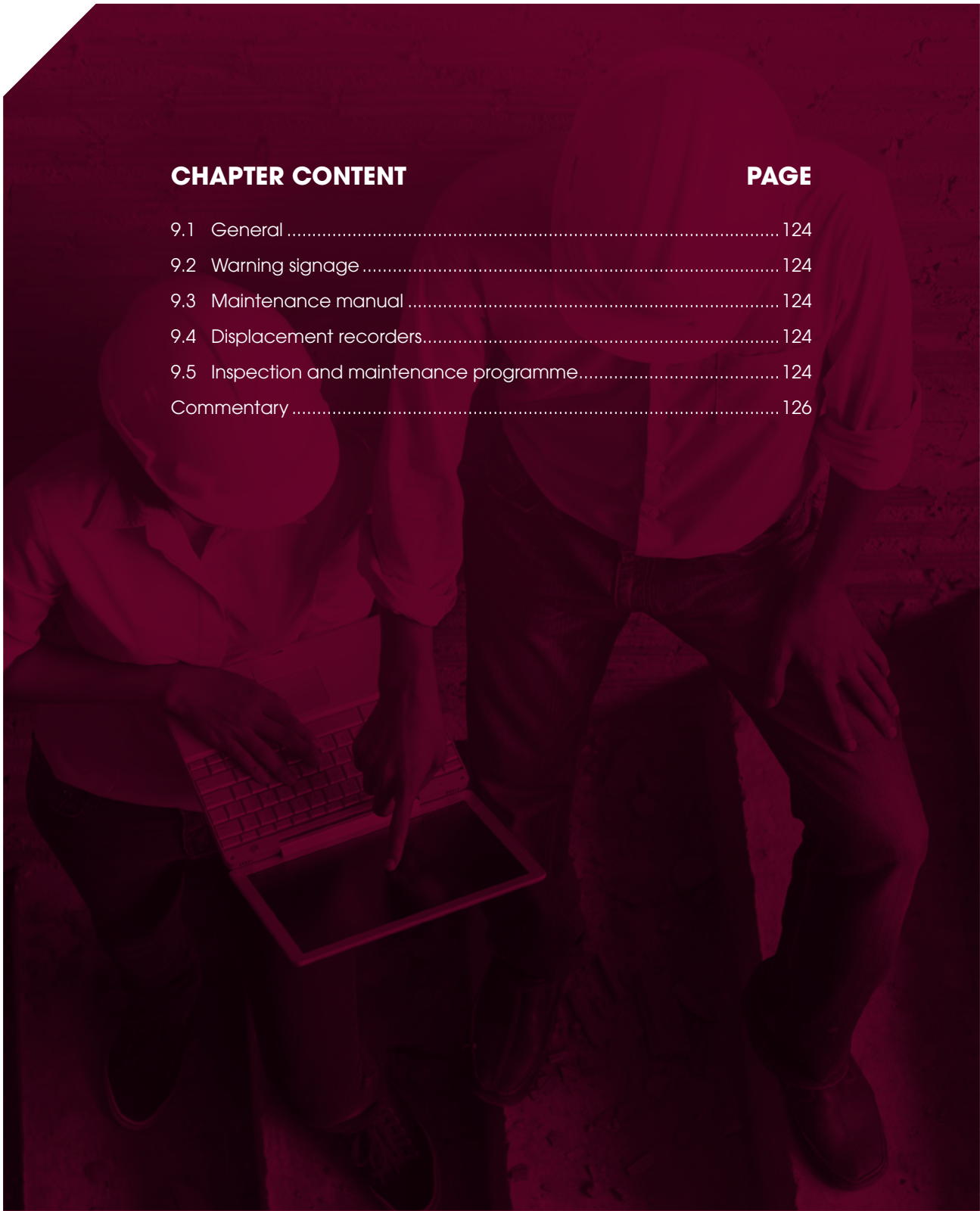

MINISTRY OF BUSINESS,  
INNOVATION & EMPLOYMENT  
HIKINA WHAKATUTUKI



**NZCS** | New Zealand  
Concrete Society



## 9.1 General

The inspection and maintenance programme should be established and agreed with the client before building consent is granted. This programme should be part of the compliance schedule and the annual building warrant of fitness certification (as required under Section 108 of the Building Act). It is the responsibility of the structural engineer to set up a fail-safe inspection and maintenance system that will outlive the structural engineer and the existence of his or her firm and be effective for the duration of the life of the building.

Designers should consider provision of one or more additional isolators of every type and store them in the building for maintenance or replacement.

## 9.2 Warning signage

With regard to the project Safety in Design requirements, it is recommended that permanent signs are posted to warn against placing objects that might prevent unobstructed movement between isolated and non-isolated structure. In particular:

- A sign should be placed at the entrance to the crawl space (if one is provided).
- Other signs should be placed around the building perimeter no further than 10 m apart to help prevent any obstructions reducing the effectiveness of the seismic movement gap.

These signs are additional to personnel safety warning signs at the ends of accessible gaps between an isolated structure and adjacent walls discussed in Chapter 7.

## 9.3 Maintenance manual

A seismic isolation manual for the building should be prepared with the final project documentation. This should be done jointly by the structural engineer, services engineer and architect, and with input from the isolation device manufacturer.

The manual's purpose is to describe the isolation system and its performance expectations and to document all seismic isolation details. Therefore, the Design Features Report will form a key section. The manual will be referred to during regular maintenance inspections and should include an inspection and maintenance programme, including checklists based on the types of devices and items for inspection as specified below.

All structural and non-structural isolation details, such as movement gap details, should be included in the manual to help future inspectors without a first-hand knowledge of the building. The process for the replacement of bearings should be included.

## 9.4 Displacement recorders

Any displacement recorders, such as scratch plates placed at the level of the isolation plane to record displacements during an earthquake, or other seismic instrumentation should be inspected and maintained as shown in Table 9-1. Refer to Section 3.6 and the associated commentary regarding building instrumentation and monitoring.

## 9.5 Inspection and maintenance programme

The inspection and maintenance programme should specify the frequency and nature of inspections of the entire seismic isolation system including:

- isolator such as bearings, sliders and dampers
- the seismic isolation plane including the perimeter seismic clearance gaps and movement joints
- flexible services pipes and wiring entering the building (Kani, 2013).

A recommended inspection regime is shown in Table 9-1. This does not include the first inspection after building completion, which is required for normal construction monitoring certification. The frequency of inspections for a particular building should also satisfy the recommendations of the hardware suppliers. Any concerns or defects observed during an inspection need to be followed up in a more detailed manner.

Reports of each inspection should be submitted to the client and copies kept for future reference. These reports should highlight any maintenance issues that need to be addressed.

The inspections listed in Table 9-1 are primarily visual. However, measurements should be made at selected identified isolator devices and points around the building perimeter of vertical and horizontal displacements of isolators, and of movement gap width. The first of these measurements should be made and reported on at building completion. Thereafter, these measurements should be made annually.

**Table 9-1: Type and frequency of inspections and items to be inspected**

Type and frequency of inspection	Items for inspection
<b>Annual inspection</b>	<ul style="list-style-type: none"> <li>• isolator devices and fire proof covers</li> <li>• perimeter movement gaps (confirming no obstacles to movement)</li> <li>• external and internal cover plates and movement joints</li> <li>• movement capability of secondary elements crossing the isolation plane including stairs, elevators, walls, service pipes, ducts, wiring</li> <li>• displacement recorders and any other instrumentation</li> <li>• a check that warning signage is in place</li> </ul>
<b>Emergency inspection after any event that might affect the isolation system such as earthquake, flood, fire and wind storm</b>	As for the annual inspection; except that after a moderate or greater earthquake the members participating in the load paths above and below the bearings need to be inspected
<b>Inspection after renovation or repairs</b>	All items within the vicinity of the isolation plane and the completed renovation or repairs are to be inspected annually.
<b>Detailed inspection every ten years</b>	<p>Selected isolators of each type in a building and other hardware with moving parts to be inspected, tested and reviewed against performance limits specified in the maintenance manual in order to confirm their ongoing adequacy.</p> <p>Physical tests are required to ensure any deterioration (which may not be visible) from an external source or some internal mechanism does not prevent an isolator device from performing as specified.</p>

## COMMENTARY

Section	Commentary
<p><b>9.1</b></p>	<p><b>General</b></p> <p>While inspection and maintenance of isolation systems is not typically a requirement of compliance schedules prepared by territorial authorities, this guideline recommends that it should be.</p> <p>One or more spare isolators may be useful during maintenance for temporary replacement of isolators removed for testing. Keeping two isolators of each type (rather than one) should be considered, as isolators are often tested back to back. If the spare isolators are not load-bearing their properties may not reflect those that are built in. This can be simulated by clamping the isolators together between steel frames.</p>
<p><b>9.5</b></p>	<p><b>Inspection and maintenance programme</b></p> <p>It is suggested that inspections are carried out together by a team that includes the structural engineer, services engineer and architect, or those delegated by them.</p>

## REFERENCES AND BIBLIOGRAPHY

- Al Atik, L. and Abrahamson, N.A. (2010). *An improved method for nonstationary spectral matching*, Earthquake Spectra 6 (3), 601–617.
- Almufti I., Motamed, M. Grant, D.N. and Willford, M. (2014). *Incorporation of velocity pulses in design ground motions for response history analysis using a probabilistic framework*. Earthquake Spectra 31 (3), 1647-1666.
- AS/NZS 1170.2:2002 *Structural Design Actions - Part 0: General Principles*, Standards Australia/Standards New Zealand.
- ASCE 7-17. *Minimum Design Loads for Buildings and Other Structures, Chapter 17, Seismic Design requirements for Seismically Isolated Structures*.
- ASCE 41-13 (2014). *Seismic Evaluation and Retrofit of Existing Buildings*, American Society of Civil Engineers, and Structural Engineering Institute, Reston, Virginia, USA.
- ASCE 41-17 (2017). *Seismic Evaluation and Retrofit of Existing Buildings*. American Society of Civil Engineers, and Structural Engineering Institute, Reston, Virginia,
- Ay, B.Ö., Fox, M.J. and Sullivan, T.J. (2017). *Technical Note: Practical challenges facing the selection of conditional spectrum-compatible accelerograms*. Journal of Earthquake Engineering 21(1): 169-180.
- Baker, J. W. and N. Jayaram (2008). *Correlation of spectral acceleration values from NGA ground motion models*. Earthquake Spectra 24 (1), 299-317.
- Baker, J.W. (2011). *The Conditional Mean Spectrum: a tool for ground motion selection*. Journal of Structural Engineering, ASCE. 137(3): 322-331.
- Baker, J.W. and Cornell, C.A. (2005). *Vector-valued ground motion intensity measures for probabilistic seismic demand analysis*. Blume Center Technical Report 150, Stanford University, Stanford, CA.
- Baker, J. W. and Cornell, C. A. (2006). *Spectral shape, epsilon and record selection*, Earthquake Engineering & Structural Dynamics, 35 (9), p. 1077-1095.
- Beyer, K. and Bommer, J.J. (2007). *Selection and Scaling of Real Accelerograms for Bi-Directional Loading: A Review of Current Practice and Code Provisions*. Journal of Earthquake Engineering, 11 (S1), p. 13-45.
- Bommer, J.J., Scott, S.G., and Sarma, S.K. (2000). *Hazard-consistent earthquake scenarios*. Soil Dynamics and Earthquake Engineering 19 (4), 219–231.
- Boore, D.M. (2010). *Orientation-independent, nongeometric-mean measures of seismic intensity from two horizontal components of motion*. Bulletin of the Seismological Society of America. 100(4), 1830-1835.
- Borzognia Y., C.B. Crouse, R.O. Hamburger, R. Klemencic, H. Krawinkler, J.O. Malley, J.P. Moehle, F. Naeim and J.P. Stewart (2010). *Guidelines for performance-based seismic design of tall buildings*. PEER Report No. 2010/05, Pacific Earthquake Engineering Research Center, University of California, Berkeley, CA.
- Borzognia, Y. and Campbell, K.W. (2004). *The vertical-to-horizontal response spectral ratio and tentative procedures for developing simplified V/H and vertical design spectra*. Journal of Earthquake Engineering, 8(2): 175-207.
- Bradley, B.A. (2010). *A generalized conditional intensity measure approach and holistic ground-motion selection*, Earthquake Engineering & Structural Dynamics, 39 (12), 1321–1342.
- Bradley, B.A. (2011). *Design seismic demands from seismic response analyses: a probability-based approach*. Earthquake Spectra, 27(1): 213-224.
- Bradley, B.A. (2012). *A ground motion selection algorithm based on the generalized conditional intensity measure approach*. Soil Dynamics and Earthquake Engineering, 40: 48-61.
- Bradley, B.A. (2014) *Seismic performance criteria based on response history analysis: alternative metrics for practical application in NZ*, Bulletin of the New Zealand Society for Earthquake Engineering, 47(3), 224-228.
- Bulletin of the Seismological Society of America* 103 (2A), 1103-1116.
- Calvi, G.M., Priestley, M.J.N. and Kowalsky, M.J. (2008). *Displacement-based seismic design of structures*, 3rd National Conference of Earthquake Engineering and Engineering Seismology, Athens, 5-7 November 2008.

- Carr, A.J. (2007). *RUAUMOKO Users Guide. Volume 1: Theory*. Department of Civil Engineering, University of Canterbury.
- Carr, A. Puthanpurayil, A (2018) *Inherent Damping in Nonlinear Time-History Analyses: A Recommended Modelling Approach*. Earthquake Engineering and Structural Dynamics in Memory of Ragnar Sigbjörnsson. DOI: 10.1007/978-3-319-62099-2\_4
- CERC (2012). *CERC Final Report Volume 3: Low-damage Building Technologies*, Canterbury Earthquakes Royal Commission (CERC), June 2012.
- Charleston, A.W. and Guisasola, A. (2017). *Seismic isolation for architects*, Routledge, London.
- Constantinou, M., Fenz, D. (2008). *Mechanical Behavior of Multi-spherical Sliding Bearings*. MCEER-08-0007.
- Crouse, C.B., Leyendecker, E.V., Somerville, P.G., Power, M. and Silva, W.J. 2006. *Development of seismic ground-motion criteria for the ASCE 7 Standard*, Proceedings of the 8th US National Conference on Earthquake Engineering, Earthquake Engineering Research Institute, Oakland, California.
- Deierlein, G.G., Reinhorn, A.M. and Willford, M.R. (2010). *Nonlinear structural analysis for seismic design*, NEHRP Seismic Design Technical Brief No. 4, National Institute of Standards and Technology (NIST), Gaithersburg, MD, NIST GCR 10-917.
- Ebrahimian, H., Azarbakht, A., Tabendeh, A., and Golafshani, A.A. (2012). *The exact and approximate conditional spectra in the multi-seismic sources regions*, Soil Dynamics and Earthquake Engineering, 39: 61-67.
- EN 15129:2009, *Anti-seismic devices*, 2009, European Committee for Standardization.
- EN 1988-2:2005, *Eurocode 8: Design of structures for earthquake resistance, Part 2: Bridges*, European Committee for Standardization.
- EN 1998-1 (2004) (English): *Eurocode 8: Design of structures for earthquake resistance – Part 1: General rules, seismic actions and rules for buildings*
- FEMA 440, *Improvement of nonlinear static seismic analysis procedures*, Applied Technology Council (ATC-55 Project), June 2005.
- FEMA (2015), *P58-1 Seismic Performance of Buildings, Volume 1-Methodology*. Federal Emergency Management Agency.
- Giammona, A.P., Ryan, K.L., Dao, N.D. (2015). *Evaluation of assumptions used in engineering practice to model buildings isolated with triple pendulum isolators in SAP 2000*, Earthquake Spectra (EERI), 31(2):637-660.
- Hamburger, Ronald. (2014). *FEMA P58 seismic performance assessment of buildings*. NCEE 2014 - 10th U.S. National Conference on Earthquake Engineering: Frontiers of Earthquake Engineering. 10.4231/D3ZW18S8N.
- Hasash, Y.M.A., Abrahamson, N.S., Olson, S.M., Hague, S. and Kim, B. (2015). *Conditional mean spectra in site-specific seismic hazard evaluation for a major river crossing in the central United States*, Earthquake Spectra 31(1), 47-69.
- Haselton, C.B., Fry, A., Baker, J. W., Hamburger, R.O., Whittaker, A.S., Stewart, J.P., Elwood, K.I., Luco, N., Hooper, J.D., Charney, F.A., Zimmerman, R.B. and Pekelnicky, R.G. (2014). *Response-history analysis for the design of new buildings: a fully revised Chapter 16 methodology proposed for the 2015 NEHRP provisions and the ASCE/SEI 7-16 standard*, Proceedings of the 10th U.S. National Conference on Earthquake Engineering, Anchorage (Alaska), July 2014, 12pp.
- Haselton, C.B., Whittaker, A.S., Hortacsu, A., Baker, J.W., Bray, J. and Grant, D.N. (2012). *Selecting and scaling earthquake ground motions for performing response-history analyses*. Proceedings of the 15th World Conference on Earthquake Engineering. Lisbon (Portugal), September 2012, 10pp.
- Huang, N.Y., Whittaker, A.S., Kennedy, R.P., Mayes, R.L. (2009) *Assessment of Base-Isolated Nuclear Structures for Design and Beyond-Design Basis Earthquake Shaking*, Tech. Report MCEER-09-0008, University at Buffalo.
- Japan Society of Seismic Isolation (JSSI) (2018). *Guidelines for wind-resistant design of base-isolated buildings* [in Japanese], JSSI, Tokyo. March 2018.
- Jayaram, N., Lin, T. and Baker, J.W. (2011). *A computationally efficient ground-motion selection algorithm for matching a target response spectrum mean and variance*, Earthquake Spectra 27(3), 797-815.



- Kalkan, E. and Chopra, A.K. (2010). *Practical guideline to select and scale earthquake records for nonlinear response history analysis of structures*.
- Kani, H. (2013). *Maintenance standards for seismic-isolation buildings*, Proceedings of the 13th World Conference on Seismic Isolation, Energy Dissipation and Active Vibration Control of Structures, Sendai, Japan, p.2.
- Kelby York & Keri L. Ryan (2008) *Distribution of Lateral Forces in Base-Isolated Buildings Considering Isolation System Nonlinearity*. Journal of Earthquake Engineering, 12:7, 1185-1204, DOI: 10.1080/13632460802003751.
- Komodromos, P., Polycarpou, P., Papaloizou, L. and Phocas, M. *Response of seismically isolated buildings considering pounding*, Earthquake Engineering & Structural Dynamics, 36:1605- 1622, Wiley, 2007.
- Lee, R.L., Franklin, M.J., and Bradley, B.A. (2013). *Characteristics of Vertical Ground Motions in the Canterbury Earthquakes*, Oral Paper No. 16, 2013 NZSEE Conference, Wellington, New Zealand.
- Lin, T., Harmsen, S.C., Baker, J.W. and Luco, N. (2013). *Conditional spectrum computation incorporating multiple causal earthquakes and ground-motion prediction models*, Bulletin of the Seismological Society of America, 103(2a): 1103-1116.
- Marriott, D.J., *The Impact of the Structural Performance Factor (SP) within a Displacement-Based Design Framework*, NZSEE conference 2017.
- Mayes, R.L., "The next generation of codes for seismic isolation in the United States and regulatory barriers to seismic isolation development", Tenth U.S. National Conference on Earthquake Engineering, Anchorage, July 2014.
- McVerry, G.H., Van Houtte, C., Kaiser, A., Holden, C., Fry, B. and Gerstenberger, M. (2017). *The transition period  $T_L$  in the recommended spectra of the draft New Zealand Seismic Isolation Guidelines*, 2017 NZSEE Conference, Wellington,
- McVitty, W.J., and Constantinou, M.C. 2015. *Property Modification Factors for Seismic Isolators: Design Guidance for Buildings*, Technical Report MCEER-15-0005, University of New York at Buffalo.
- Mosqueda, G., Masroor, A., *Limit State Tests and FEMA P695 Analysis Considering Pounding to Moat Walls*, NEES Research to Practice Webinar, Nov 20, 2013.
- Naeim, F., and Lew, M. (1995). *On the use of design spectrum compatible time histories*.
- Nagarajaiah, S., Xiaohung, S., *Base-Isolated FCC Building: Impact Response in Northridge Earthquake*, Journal of Structural Engineering 127(9), pp 1063-1075, ASCE, September 2001.
- NIST (2011). *Selecting and scaling earthquake ground motions for performing response-history analyses*, NIST GCR 11- 917-15, prepared by the NEHRP Consultants Joint Venture for the National Institute of Standards and Technology (NIST), Gaithersburg, Maryland, USA, 256pp.
- NZS 1170.5:2004 *Structural Design Actions Part 5 Earthquake actions - New Zealand, Incorporating Amendment No.1*, Wellington, NZ, September 2016.
- NZS 3101:2006 *Concrete structures standard*, Standards New Zealand, Wellington, NZ.
- NZS 3404:2009 *Steel structures standard*, Standards New Zealand, Wellington, NZ.
- NZS 4203: 1992 *General structural design and design loadings for buildings*, Standards New Zealand, Wellington, NZ.
- NZS 4219:2009 *Seismic performance of engineering systems in buildings*, Standards New Zealand, Wellington, NZ.
- NZSEE (2017). *The Seismic Assessment of Existing Buildings: Technical Guidelines for Engineering Assessments*, jointly published by the New Zealand Society for Earthquake Engineering (NZSEE), the Structural Engineering Society (SESOC), New Zealand Geotechnical Society (NZGS), Ministry of Business, Innovation and Employment (MBIE) and the Earthquake Commission (EQC), Wellington, New Zealand, July 2017.
- NZTA Bridge Manual SP/M/002 (Third edition, Amendment 2, effective May 2016).
- NZTA Draft DBD9, 20130514, *Proposed Provisions for deflection-based design, and Commentary*.
- Oyarzo-Vera, C.A., McVerry, J H. and Ingham, J.M. (2012). *Seismic zonation and default suite for ground-motion records of time-history analysis in the North Island of New Zealand*. *Earthquake Spectra* 28 (2), 667-688.

- Priestley, M.J.N., Calvi, G.M. and Kowalsky, M.J. (2007). *Displacement-based seismic design of structures*, IUSSP Press, Pavia, Italy.
- Quakestar, [www.quakestar.org.nz](http://www.quakestar.org.nz)
- REDi™, REDi™ Rating System, Version 1.0, Arup October 2013
- Reiter, L. (1990). *Earthquake Hazard Analysis: Issues and Insights*, Columbia University Press, New York.
- Ryan, K. and Dao, N. (2016). *Influence of Vertical Ground Shaking on Horizontal Response of Seismically Isolated Buildings with Friction Bearings*, Journal of Structural Engineering, 10.1061/(ASCE)ST.1943-541X.0001352, 04015089.
- Saiki, K., Kitamura, Y. and Kani, N. (2013). *Damage of expansion joints for seismically isolated buildings and countermeasures*, Proceedings of the 13th World Conference on Seismic Isolation, Energy Dissipation and Active Vibration Control of Structures, Sendai, Japan.
- Shahi S. and Baker, J. W. (2011). *An empirically calibrated framework for including the effects of near-fault directivity in probabilistic seismic hazard analysis*, Bulletin of the Seismological Society of America 101 (2), 742-755.
- Skinner, R.I., Robinson, W.H. and McVerry, G.H., (1993). *An Introduction to Seismic Isolation*, John Wiley and Sons, Chichester, England, 354 pp.
- Skinner, R.I., Kelly T.E., Robinson W.H. (2010) *Seismic isolation for designers and structural engineers*. 387 pages.
- Stewart, J.P., K. Afshari and Y.M.A. Hashash (2014). *Guidelines for performing hazard-consistent one-dimensional ground response analysis for ground motion prediction*. Pacific Earthquake Engineering Research Center. PEER Report 2014/16, October 2014, 152pp.
- Tremayne, B. and Kelly, T.E. (2005) *Time history analysis as a method of implementing performance based design*, paper 19, 2005 NZSEE Conference.
- URSC-EQ Performance Rating system, [www.usrc.org](http://www.usrc.org).
- Van Houtte, C., Bannister, S., Holden, C., Bourguignon, S. and McVerry, G. (2017). *The New Zealand strong motion database*, Bulletin of the New Zealand Society for Earthquake Engineering, 50(1): 1-20.
- Warn, G.P., Whittaker A.S., *A study of the coupled horizontal-vertical behavior of elastomeric and lead-rubber seismic isolation bearings*. ASCE Journal of Structural Engineering. 2006.
- Warn G.P., Whittaker A.S., Constantinou M.C., *Vertical stiffness of elastomeric and lead-rubber seismic isolation bearings*, ASCE Journal of Structural Engineering, 2007
- Whittaker D. and Jones, L. R. (2014). *Displacement and acceleration design spectra for seismic isolation systems in Christchurch*. NZSEE Conference, 2014.
- York, K. and Ryan, K.L. (2008). *Distribution of Lateral Forces in Base-Isolated Buildings Considering Isolation System Nonlinearity*, Journal of Earthquake Engineering, 12:7, 1185-1204, DOI: 10.1080/13632460802003751.

## APPENDIX A - DEFINITIONS AND ABBREVIATIONS

Term	Definition
<b>ADRS</b>	Acceleration-displacement response spectrum
<b>Arias Intensity</b>	A measure of the strength of a ground motion, which determines the intensity of shaking by measuring the acceleration of transient seismic waves.
<b>Base level (or seismic base)</b>	The level of the isolated structure just above the isolation interface.
<b>Building Act</b>	Building Act 2004
<b>Building Code</b>	Schedule 1 to the Building Regulations 1992
<b>CALS</b>	Collapse avoidance limit state
<b>CMS</b>	Conditional mean spectrum
<b>COM</b>	Centre of mass
<b>CS</b>	Conditional spectra
<b>CSS</b>	Curved surface slider, a type of isolator also known as a 'pendulum' or 'Friction Pendulum™'.
<b>DBD</b>	Displacement-based design
<b>DBE</b>	Design basis earthquake, meaning the same as the design earthquake (at ULS) in NZS 1170.5:2004.
<b>DCLS</b>	Damage control limit state
<b>DDBD</b>	Direct displacement-based design
<b>Displacement restraint system</b>	A collection of structural elements that restrains or limits lateral displacement of seismically isolated structures.
<b>Effective damping</b>	The value of equivalent viscous damping corresponding to energy dissipated during cyclic response of the isolation system.
<b>Effective stiffness</b>	The value of the lateral force in the isolation system, or an element thereof, divided by the corresponding lateral displacement.
<b>ESA</b>	Equivalent static analysis (similar to Equivalent Lateral Force procedure in ASCE 7).
<b>EQ</b>	Short version of the word earthquake, refers to the USRC-EQ rating
<b>FS</b>	Flat slider
<b>GCIM</b>	Generalised conditional intensity measure
<b>GMPE</b>	Ground-motion prediction equation
<b>HDR</b>	High damping rubber
<b>HVAC</b>	Heating, ventilation and air conditioning
<b>IBC</b>	International Building Code
<b>IL</b>	Importance level of a building based on its function and occupancy, as defined in AS/NZS 1170.0:2002.
<b>Isolation interface</b>	The boundary between the upper portion of the structure, which is isolated, and the lower portion of the structure, which moves rigidly with the ground. Also referred to as the isolation plane.
<b>Isolation system</b>	The collection of structural elements that includes all individual isolators, all structural elements that transfer force between elements of the isolation system, and all connections to other structural elements. The isolation system also includes the wind restraint system, energy dissipation devices, and/or the displacement restraint system if such systems and devices are used to meet the design requirements.

Term	Definition
<b>Isolator</b>	A horizontally flexible and vertically stiff structural element of the isolation system that permits large lateral deformations under seismic shaking. An isolator is permitted to be used either as part of, or in addition to, the weight-supporting system of the structure.
<b>LDD</b>	Low damage design
<b>LRB</b>	Lead rubber bearing
<b>Maximum displacement</b>	The maximum lateral displacement, excluding additional displacement due to actual and accidental torsion, required for design of the isolation system. The maximum displacement shall be computed separately using upper bound and lower bound properties.
<b>MBIE</b>	Ministry of Business, Innovation and Employment
<b>MCE</b>	Maximum considered earthquake, equivalent to the rare earthquake referred to in NZS 1170.5:2004.
<b>MDOF</b>	Multi degree of freedom
<b>MRSA</b>	Modal response spectrum analysis
<b>NEHRP</b>	National Earthquake Hazards Reduction Program
<b>NITHA</b>	Numerical integration time history analysis (generally non-linear)
<b>NRB</b>	Natural rubber bearing
<b>NZBC</b>	See 'Building Code'
<b>NZSEE</b>	New Zealand Society for Earthquake Engineering
<b>P-delta</b>	The structural actions induced as a consequence of the gravity loads being displaced horizontally due to horizontal actions.
<b>PGA</b>	Peak ground acceleration
<b>PGV</b>	Peak ground velocity
<b>PTFE</b>	Polytetrafluoroethylene (brand name Teflon)
<b>QA</b>	Quality assurance
<b>QC</b>	Quality control
<b>Scragging</b>	Application of several, generally large cycles of deformation to a virgin rubber device. Scragging reduces the stiffness of the device for subsequent smaller deformations, although some of the stiffness loss may be recovered over time.
<b>SDOF</b>	Single degree of freedom
<b>SESOC</b>	Structural Engineering Society New Zealand Inc.
<b>SLS</b>	Serviceability limit state in accordance with AS/NZS 1170.0:2002.
<b>Seismic base</b>	See Base level.
<b>SSI</b>	Soil-structure interaction
<b>Substructure</b>	Part of the structure located under the isolation interface including the foundation.
<b>Superstructure</b>	Part of the structure located above the isolation interface.
<b>Total maximum displacement</b>	The total maximum lateral displacement, including additional displacement due to actual and accidental torsion, required for verification of the stability of the isolation system or elements thereof, design of structure separations, and vertical load testing of isolator unit prototypes. The total maximum displacement shall be computed separately using upper bound and lower bound properties.
<b>UBDP</b>	Upper bound design properties
<b>UHS</b>	Uniform hazard spectrum
<b>ULS</b>	Ultimate limit state in accordance with AS/NZS 1170.0:2002.
<b>VD</b>	Viscous damper
<b>Wind restraint system</b>	The collection of structural elements that provides restraint of the seismic isolated structure for wind loads. The wind restraint system is permitted to be either an integral part of isolator devices or a collection of separate devices.
<b>%NBS</b>	The rating given to a building as a whole expressed as a percentage of new building standard achieved, based on an assessment of the expected seismic performance of an existing building relative to the minimum that would apply under the Building Code to a new building on the same site with respect to life safety.

## APPENDIX B - NOTATION

Notation	Definition
$A_h$	Area within isolation plane hysteresis loop
$B_\xi(T, \xi_{eff})$ or $B_\xi$	Spectrum scaling factor to account for effective damping of isolation system $\xi_{e,i}$
$\beta_m$	Effective damping of the isolation system at the design displacement
$C(0)$	Modified site hazard coefficient just above the isolation plane
$C_{hi}$	Floor height coefficient as determined by NZS 1170.5:2004
$C_{d, isolated}$	Seismic coefficient for the design of superstructure above the isolation plane
$C_h(T)$	Spectral shape factor
$C_h(T_L)$	Spectral shape factor for corner period $T_L$
$C_i(T_p)$	Part spectral shape factor at level i as determined by NZS 1170.5:2004
$C_p(T)$	Elastic site spectra coefficient for horizontal loading
$C_{mx}$	Base shear distribution coefficient based on mass only and uniform acceleration over the height
$C_p(T_p)$	Seismic coefficient for a building part
$C(T)$	Elastic site spectra coefficient
$C_{vi}$	Vertical distribution factor
$C_{vx}$	Base shear distribution coefficient based on linear acceleration distribution over the height
$D$	Shortest distance (km) from the site to the closest of the major faults
$D_M$	Maximum displacement of SDOF isolation system at CALS limit state, used to check material deformation limits of isolators
$D_{TD}$	Total maximum displacement of elements of the isolation system including the effects of torsion (usually at a corner of the building) under the ULS level response.
$D_{TM}$	Maximum total displacement at isolation plane accounting for torsion/plan dimension (usually at a corner of the building). Used to size clearance and rattle space,
$E_{loop}$	Energy dissipated within one cycle of the isolation system movement
$e_{tot,y}$	Total eccentricity in the y direction
$F_1$	ESA lateral force at the base level
$F_{max}$	Horizontal force corresponding to $\Delta_{max}$
$F_{min}$	Horizontal force corresponding to $\Delta_{min}$
$F_{mx}$	Force applied in ESA to the mass at level x
$F_x$	ESA lateral force at level x , $x > 1$
$G$	Deadload
$g$	Acceleration of gravity 9,810 mm/sec <sup>2</sup>
$h_x$	Height at level x above the isolation level
$K$	Exponent
$k_1$	Record scale factor
$k_2$	Family scaling factor

Notation	Definition
$K_d$	Second branch (ie after yield point) stiffness of bilinear system
$K_{d,e}$	Effective stiffness of the system at maximum design displacement
$k_{dm}$	Drift modification factor as per NZS 1170.5
$K_{eff}$	Effective stiffness of the hysteresis loop
$K_r$	Stiffness of rubber in a lead rubber bearing
$k_\mu$	Force reduction factor applied to elastic acceleration response spectrum
$k_{\mu,superstructure}$	Force reduction factor applied to superstructure elastic response forces
$k_{xi}$	Effective stiffness of a given unit i in the x direction
$k_{yi}$	Effective stiffness of a given unit i in the y direction
$m_e$	Effective structural mass – all components above the isolation plane
$m_i$	Mass of the basement (podium) level
$M_w$	Regional event moment magnitude
$N(T,D)$	Near-fault factor as per NZS 1170.5
$P_T$	Displacement torsion amplification factor for ESA
$Q_d$	Force at which the force-displacement loop intersects the force axis. Applies to either an individual isolator or an isolation system overall.
$Q_{d,nom,elastomeric}$	Force at which the force-displacement loop for a system using elastomeric isolators crosses the force axis, assuming nominal properties
$Q_{d,UB,friction}$	Force at which the force-displacement loop for a system using curved surface slider isolators crosses the force axis, assuming upper bound properties
$Q_u$	Reduced live load as per NZS 1170.1
$R$	Radius of curved surface slider. Return period factor
$R_{CALs}$	Return period factor for the collapse avoidance limit state
$R_u$	Return period factor for the ULS appropriate to the structure importance level
$r_y$	Torsional radius of the isolation system in the y direction
$S_{a,capacity}$	Equivalent SDOF acceleration capacity (shear force divided by effective mass) at isolation plane
$S_{aM,TDmax}$	CALS 5%-damped spectral acceleration parameter at the period, $TD_{max}$ (g)
$S_d$	Lateral displacement above the isolation plane, of the SDOF system
$SA(T)$	Acceleration response spectrum
$S_p$	Structural performance factor
$S_{p,iso}$	Structural performance factor – elements at and below the isolation plane
$S_{p,superstructure}$	Structural performance factor used for design of the superstructure.
$SD_{max}$	The maximum spectral displacement of a pseudo-displacement spectrum.
$SV_{max}$	The maximum spectral velocity from a pseudo-displacement spectrum.
$TD_{max}$	Effective period of the seismically isolated structure at the displacement $D_{MAX}$ in the direction under consideration
$T$	Period (secs)
$T_{1eff}$	Effective fundamental period of isolated system
$T_{1elastic}$	Fundamental period for the isolated system during elastic phase response of the isolators

Notation	Definition
$T_{2\text{ elastic}}$	Elastic-phase second-mode period of the superstructure-isolator system
$T_{\text{eff}}$	Effective period of isolated structure
$T_{\text{eff,ULS}}$	Effective period of isolated structure at ULS
$T_{\text{fixed base}}$	The fundamental period of the structure above the isolation interface determined using a rational modal analysis assuming fixed-base conditions
$T_{1, \text{fixed base}}$	First-mode fixed-base superstructure period
$T_L$	Corner period (secs) in acceleration responses spectrum.
$T_p$	Period of the part
$T_{\text{site}}$	Site period
$V_{\text{base}}$	Base shear of the SDOF isolation system
$V_{\text{capacity}}$	Base shear capacity of the SDOF isolation system, used for iteration of Sa performance point
$V_{\text{s,CALS}}$	The design base shear at CALS limit state, considering weight above the isolation plane, excluding the seismic weight of the base level.
$V_{\text{ST}}$	The unreduced design base shear considering the effective seismic weight of the structure above the isolation interface
$V_{\text{s, ULS}}$	The design base shear at ULS limit state, considering weight above the isolation plane, excluding the seismic weight of the base level.
$W$	Effective seismic weight of the structure above the isolation interface (kN)
$W_s$	Effective seismic weight of the structure above the isolation interface excluding the effective seismic weight of the base level (kN)
$W_u$	Factored design wind load at ultimate limit state as per NZS 1170.2
$W_x$	Portion of $W_s$ that is located at or assigned to Level i or x
$Z$	Hazard factor as per NZS 1170.5
$\alpha$	Isolation system robustness factor. Damping exponent
$\Delta$	Isolator displacement
$\Delta_d$	Design displacement of SDOF isolation system above isolation plane --> use for base shear calculation
$\Delta_{d,es}$	Design displacement of SDOF isolation system above isolation plane, used to calculate the SDOF base shear and should converge with $S_d$ (spectral displacement at effective period).
$\Delta_{d,s}$	Displacement within superstructure
$\Delta_i$	Displacement of isolation system
$\Delta_h(T)$	Displacement spectral shape factor
$\Delta(T)$	Elastic site displacement spectra
$\Delta_h(T, T_{\text{site}})$	Site-period based spectral shape factors (mm)
$\Delta_{\text{max}}$	Maximum positive horizontal displacement of the isolator unit during testing
$\Delta_{\text{min}}$	Maximum negative horizontal displacement of the isolator unit during testing
$\delta_{xi}$	Torsion amplification factor for SDOF analysis as calculated in Equation 5-8

Notation	Definition
$\mu_{\max, \text{superstructure}}$	Maximum superstructure inter-storey drift or plastic rotation
$\lambda_{\max}, \lambda_{\min}$	Upper and lower bound factors for the variability of isolator parameters
$\mu$	Coefficient of friction for planar and curved surface sliders
$\mu_{\max}$	Superstructure design displacement ductility
$\mu_{\text{superstructure}}$	Superstructure design displacement ductility factor
$\xi_{\text{eff}}$	Effective damping as a fraction of critical damping
$\xi_{e,i}$	Effective damping in the isolation system
$\xi_{e,s}$	Effective viscous damping due to energy dissipation in the superstructure
$\xi'_{\text{sys}}$	Equivalent viscous damping of system
$\phi$	Material strength reduction factor



# APPENDIX C – SAMPLE SPECIFICATION FOR SEISMIC ISOLATION SYSTEM COMPONENTS

The content of this sample Specification will need to be edited to suit the project. Items in square brackets [...] will require amendment or specific detail to be provided.

## SEISMIC ISOLATION SYSTEM AND ISOLATION DEVICES

### SI-00 SECTION INDEX

SI-00	Seismic Isolation - General
SI-01	Curved Surface Slider Isolators
SI-02	Elastomeric Isolators
SI-03	Flat Slider Isolators
SI-04	Viscous Damping Devices

### SI-00 – SEISMIC ISOLATION - GENERAL

#### SI-00.0 INDEX

SI-00.1	Preliminary
SI-00.2	Scope
SI-00.3	Pre-Qualification and Tendering
SI-00.4	Referenced Documents
SI-00.5	Alternate Isolation System Designs
SI-00.6	Certification and Warranties
SI-00.7	Delivery, Storage, Handling and Installation

#### SI-00.1 PRELIMINARY

Refer to the **CONDITIONS OF CONTRACT** and **PRELIMINARY AND GENERAL** which shall apply to this section of the Contract Works.

#### SI-00.2 SCOPE

The work covered by this section includes the supply of the Seismic Isolation System components as indicated on the project Drawings.

This specification includes requirements for the design, manufacture, supply and installation of the Seismic Isolation System for the project. It shall be read in conjunction with *[relevant specification sections for Concrete and Structural Steel etc]* where applicable.

The “Seismic Isolation System” refers to the components required to provide seismic isolation, damping and attachment of the devices to the structure. The proposed system consists of *[insert summary of bearing number and types required including spare]* isolation devices including temporary and permanent *[attachment plates, attachment bolts etc]*.

**The scope of work will consist of:**

- The design of the Seismic Isolation *[System and]* components to meet the design criteria given in this specification and on the structural Drawings.
- Design and supply of isolation devices, any interfacing plates and attachment/anchor bolts to meet the design criteria given in this specification and on the Structural Drawings.
- Coordination of attachment bolts with primary structure above and below the isolators.
- Preparation and submission of Quality Assurance procedures.
- Manufacture and assembly of required Prototype and Production isolation devices.
- Testing of the completed devices to demonstrate compliance with the design criteria.
- Procurement of an Independent Verification Engineer to be approved by the Principal's Engineer.
- Adjustment of the design of the isolation devices should quality control checks show deviation from the design criteria outside of the permissible range as defined by this specification.
- Supply of the assembled devices to the site to suit the required programme.
- Supply of permanent dust protection to devices.
- Certification and warranty of the system (including certification of the correct installation)
- Supply of inspection and maintenance manuals for the system and devices.

**SI-00.3 PRE-QUALIFICATION AND TENDERING**

Only contractors (suppliers) that have a minimum of *[five]* years supply history shall be considered for this project. Contractors that have had any failure or rejection of product within the last 10 years shall identify these projects in their submissions, and highlight reasons for failure of product. Any non-disclosure will automatically lead to disqualification of a tender.

**SI-00.4 REFERENCED DOCUMENTS**

This Specification shall be read in conjunction with the following Standards, which are deemed to form a part of this Specification. All materials and workmanship shall comply with these Standards unless expressly noted otherwise in this Specification or in the Drawings. In the event of this Specification being at variance with any provision of the Standards, the requirements of this Specification shall take precedence over the provisions of the Standards. Reference to any Standard shall include any amendments thereto and any Standard in substitution therefor. Further requirements in this Specification are in amplification/extension of these Standards.

NZBC	New Zealand Building Code
AS/NZS 1170:2002	Structural design actions
ASCE 7-16, Chapter 17	Seismic Design Requirements for Seismically Isolated Structures
EN 15129:2009	Anti-seismic Devices
ASTM B29-03 (2009)	Specification for Lead
ASTM E37-5 (2011)	Chemical Methods for the Analysis of Lead
NZS 3404:1997	Steel Structures Standard
AS/NZS 1252:1996	High Strength Steel Bolts
ASTM A1011-A1011M-12b	Specification for Structural Sheet Steel
NZS 1554	Welding of Steel Structures
AS/NZ 2312:2014	Steel protective coatings

## SI-00.5 ALTERNATE ISOLATION SYSTEM AND DEVICE DESIGNS

Prospective Contractors are required to submit a complying tender for the *[isolation system and]* devices as shown on the Structural Drawings. Alternate designs *[will not be considered/may be considered provided they meet the total system design criteria as specified on the Structural Drawings and in this specification]*.

A Contractor who wishes to submit alternative types of isolation systems or isolation devices must supply sufficient information to determine the performance of the alternatives, and indicate how this will be verified. Should alternate systems require the Design Engineer to carry out reanalysis and/or re-documentation of the building structure, such reanalysis and/or re-documentation shall be at the Contractor's expense unless agreed otherwise.

## SI-00.6 CERTIFICATIONS AND WARRANTIES

### .1 Certification

In addition to any technical submittals required by this specification, the following documentation will be required as certification of the design/verification process in order to satisfy the requirements of the New Zealand Building Code:

- Producer Statement – PS4 – Construction Review, signed by the Independent Verification Engineer, for the prototype testing of the bearings.
- Producer Statement – PS3 – Construction, signed by the isolation device manufacturer, to certify that the fabrication and production testing has been carried out in accordance with the requirements of the device designer and in compliance with this specification. Certifications from contributing suppliers shall be attached. This shall include attending the site at the completion of installation to (visually) inspect for installation in compliance with the requirements and for and signs of damage.
- Producer Statement – PS1 – Design, signed by the isolation device manufacturer, to certify that the detailed design of all seismic isolation system components meets the design criteria stipulated in this specification and on the Structural Drawings.

Should alternate designs be proposed, if permitted by SI-00.5, additional certification (for example Producer Statement – PS1 – Design) will be required for aspects which cannot be directly verified from testing.

### .2 Independent Verification Engineer

In order to provide an independent check on the verification method (prototype testing) and quality assurance (production testing) an Independent Verification Engineer shall be employed to oversee the testing of the isolation devices and provide the certifications above. All costs related to employing the Independent Verification Engineer and required activities shall form part of this contract.

The name of the proposed Independent Verification Engineer shall be submitted with the tender with sufficient information to demonstrate their independence, qualifications and professional standing. The acceptance of the Independent Engineer shall be at the discretion of the Engineer (Design Engineer and Engineer to the Contract).

The Independent Verification Engineer shall monitor and report on:

- 100% of the prototype testing
- *[at least 10%]* of the production testing, on a “random basis” in agreement with the Engineer. Monitoring and reporting shall be in sufficient detail to provide reasonable evidence that the procedures required by the design and this specification have been adhered to.

Should any re-testing be necessary, the Independent Verification Engineer shall monitor such testing, to the same level as above, at the expense of the Contractor.

### .3 Warranty

Should any devices be found to be defective or to have a fault due to manufacture or handling within 10 years from the date of supply then replacement devices shall be supplied and installed at the supplier's cost.

The tenderer shall submit a proposed form of warranty.

## **SI-00.7 DELIVERY, STORAGE, HANDLING AND INSTALLATION**

Deliver prototype and production test devices to the appropriate testing facilities.

Deliver all Production devices to the main contractor's nominated storage area in *[project location]* in protective weatherproof packaging for freight and handling purposes.

Handle components carefully to prevent damage, breaking, denting or scoring. Packaging shall protect the components from dirt, fumes, construction debris and physical damage. Components shall be stored on wood spacers, provided by the manufacturer, to allow for transport by forklift. Damaged devices or components will be rejected.

The Contractor shall carry insurance to cover the total costs, including delays etc. for damage or loss until all components are delivered and accepted at the required delivery site.

Devices shall be supplied with all required installation instructions.

The Contractor shall allow to inspect the installed isolators and to certify that the installation meets the supplier's tolerances and other requirements. The Project Manager will advise the timing of this which will be some time after the date for delivery.

## **SI-00.8 FINAL REPORT, CERTIFICATION AND MAINTENANCE MANUAL**

### **.5 Final Report, Certification and Maintenance Manual**

Submit the following as a final report, certification and maintenance requirements, the following documentation shall include any adjustments made during production:

- A summary of test data from materials tests, prototype device tests, and production device tests shall be documented in a bound report titled 'Final Seismic Isolation System Test Report'. All certifications including signed producer statements as required shall be appended.
- A maintenance manual containing:
  - Specifications for all protective coatings, covers, boots etc. including all warranties etc.
  - Full descriptions of rehabilitation procedures and expected maintenance cycles.
  - Relevant suppliers and contact details.
  - Full shop drawings of each device type.
  - Schedule of device numbers and supply dates.
  - Recommended inspection and maintenance.

## SI-01 – CURVED SURFACE SLIDER ISOLATORS

### SI-01.0 INDEX

SI-01.1	Design Criteria
SI-01.2	Submittals
SI-01.3	Materials
SI-01.4	Assembly and Fabrication Criteria and Tolerances
SI-01.5	Prototype Device Testing
SI-01.6	Production Device Testing

### SI-01.1 DESIGN CRITERIA

Design Criteria for the Seismic Isolation System shall be as specified on the Structural Drawings and in accordance with the Table below. *[Amend Table and numbers to suit project.]*

Parameter	Overall System Behaviour
ULS Period (sec)	[2.5] sec
Design Displacement	[+/- 250] mm
Total Design Displacement (including allowance for torsion)	[+/- 300] mm
CALS Period (sec)	[2.8] sec
Maximum Displacement (at Centre of Mass)	[+/- 450] mm
Total Maximum Displacement (including allowance for torsion)	[+/- 500] mm

Design criteria for each device type shall be as specified on the Structural Drawings and in accordance with the Table below. The location of each of the device types is indicated on the Structural Drawings. *[Amend Table and numbers to suit project.]*

Parameter	Device Type		
	Type A	Type B	Type C
No. of Devices	#A	#B	#C
Friction coefficient	0.08 +/- 20%	0.08 +/- 20%	0.08 +/- 20%
Effective radius of curvature	4.0 m	4.0 m	4.0 m
Total Design Displacement (including allowance for torsion)	+/- 300 mm	+/- 300 mm	+/- 300mm
Total Maximum Displacement (including allowance for torsion)	+/- 500 mm	+/- 500 mm	+/- 500 mm
Minimum Effective Damping at Design Displacement (250mm)	30%	30%	30%
Average service axial load (G+ΨQ)	1000 kN	1000 kN	1000 kN
Maximum ultimate axial load capacity (1.2G + 1.5Q)	1500 kN	1500 kN	1500 kN
Working axial load in earthquake (G+ΨeQ)	1500 kN	1500 kN	1500 kN
Maximum axial load in ULS earthquake (G+ΨeQ+E <sub>ULS</sub> )	2000 kN	2000 kN	2000 kN
Maximum axial load in CALS earthquake (G+ΨeQ+E <sub>CALS</sub> )	3000 kN	3000 kN	3000 kN

Note that design loading combinations are defined as AS/NZS 1170. Effective damping is to be determined based on a method approved by the Design Engineer.

### .1 Geometry

Geometry shall be generally as indicated on the Structural Drawings and summarised in the limits here. The contractor is to supply top and bottom plates as indicated in the Structural Drawings. The contractor is to provide top and bottom fixing plate templates for co-ordination of cast in fixings and bolts.

Should the device design not comply with geometry indicated on the Structural Drawings and summarised below, the contractor shall submit the proposed geometry to the Engineer and Main Contractor for approval.

Alternate geometry may require the Engineer to carry out reanalysis and/or re-documentation of the building structure including, by not limited to, the fixings to the main structure as indicated on the Structural Drawings. Such reanalysis and/or re-documentation shall be at the Contractor’s expense.

Allowance shall be made for supplying and locating attachment/anchor bolts within the geometric constraints.

*[Amend details to suit project.]*

Parameter	
Plan shape	<i>[Square/Circular]</i>
Maximum Diameter of device base plate	1000mm
Maximum overall height of device	250mm

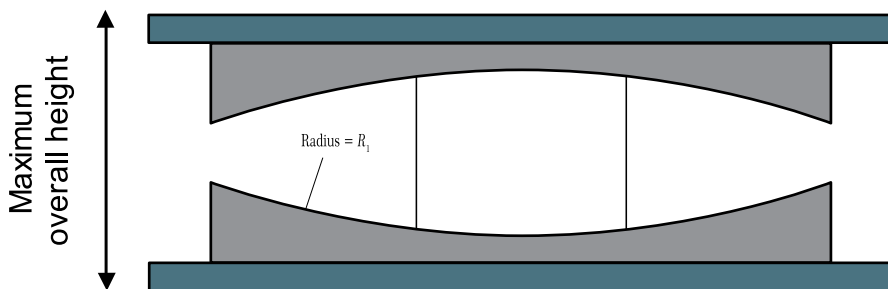

### .2 Allowable Bearing Pressures

The primary structure immediately above and below the devices is able to carry a maximum bearing pressure of *[50MPa (ULS)]*. The contractor shall ensure that the device-structure interface does not exceed this bearing pressure under the specified loads and displacements. Additional bearing plates shall be provided by the isolator supplier if necessary.

### .3 Design Life, Durability, Fire Resistance and Maintenance

The isolation system shall have a design life of *[100]* years as a primary structural component. All bearings are to be fully accessible to allow periodic inspection and maintenance. Maintenance shall not be more regular than *[20]* years. A schedule of all requirements for maintenance shall be provided by the contractor with the Final Report and Certification. Recommendations for inspection and maintenance procedures shall be provided with the tender.

### .4 Replacement

Isolation device top/bottom plates shall be designed to allow complete future removal and replacement without damaging the fixing system or immediate structure and without raising the adjacent structure more than 5mm.

## SI-01.2 SUBMITTALS

The contractor shall undertake the work in five Phases as set out below. The Contractor shall not proceed to the next phase until all review comments have been satisfied unless explicitly notified in writing. Proceeding without this approval shall be at the contractor’s risk.

## **.1 Tender Submission**

The following is required for the tender submittal:

- Summary of proposed component performance compared to each of the design criteria listed in SI-01.1
- Summary of properties of each device in the system including initial stiffness, friction (as varies with speed and axial load) as relevant to the device type.
- Qualification data for similar devices manufactured and supplied by the contractor.
- Summary of testing apparatus (if possible annotated illustrations of all proposed test apparatus) and procedures for tests to demonstrate how the particular requirements of the specification are to be satisfied.
- Name, contact details, qualifications and experience of the proposed Independent Verification Engineer.
- Preliminary shop drawings of each component type indicating size of each device and its mounting plate, including indicative fixings.
- A summary of materials testing proposed including what testing will be project specific and what will be based on previous test data and/or other manufacturer's product specifications.
- Manufacturer's product specifications where utilised as above, including handling and assembly procedures.
- Outline maintenance schedule to achieve the design life.
- The proposed form of warranty.
- Proposed design, testing and production programme.
- Confirmation that the supplier can meet the project construction programme.

## **.2 Materials, Component and Process Design**

The following information is required at completion of design prior to manufacture of the prototypes:

- Shop drawings for each device type indicating:
  - All dimensions and weights
  - Arrangement of parts and their individual geometries
  - Method of assembly
  - Packaging and handling
  - Installation method and installation drawings including bolting templates
- Identification of what standards component materials are manufactured/fabricated to.
- Details of corrosion protection to be provided.
- Source and Quality Assurance information for all plate materials and bolts, including certification of manufacturer and/or personnel involved with any welding or machining processes.
- Certifications that all testing equipment has been checked for accuracy by appropriate standards (ASTM E4, etc.) for the purpose of this contract. Detailed annotated and drafted illustrations of all proposed test apparatus where not covered by the tender submission.

## **.3 Prototype Device Testing**

Submit a report including the following information for each test required under SI-01.4

- Date, time, temperature and test rig identification.
- Names of technicians operating the rig and all observers (Independent Verification Engineer etc.) present.
- Force vs. deflection plots for all tests.
- Force (or displacement) vs. time plots for all tests with horizontally applied loads.
- Force vs. velocity plots for all slider tests involving horizontally applied loads.
- Photographs of devices where "inspection" is required in test procedure.
- Derivation of characteristics listed in design requirements.
- Comparison of results with target parameters.
- Interim test data shall be made available to the observing team for discussion of results before the final report is issued to allow for adjustments to be made to the design or process if required.

#### .4 Production Device Test Submissions

For each production test submit a report including the following information.

- Date, time, temperature and test rig identification.
- Names of technicians operating the rig and all observers (Independent Verification Engineer etc.) present.
- Force vs. deflection plots for all tests.
- Force (or displacement) vs. time plots for all tests with horizontally applied loads.
- Force vs. velocity plots for all slider tests involving horizontally applied loads.
- Photographs of devices where “inspection” is required in test procedure.
- Derivation of characteristics listed in design requirements.
- Comparison of results with target parameters.
- Proposals for adjustments to materials to correct future production if necessary to achieve correct system response and for all devices produced since the previous production submission.
- Certified test reports demonstrating purity of materials as relevant.
- Certified mill test reports for all steel mounting plate and connecting plate materials and bolts.

### SI-01.3 MATERIALS

#### .1 Component Materials

The supplier shall submit details of all component materials to the Engineer for review, along with identification of what standards the materials comply with. Device components include but are not necessarily limited to:

- The top and bottom plates.
- The plate liners.
- The puck.
- The puck coating.
- Bearing plates

### SI-01.4 ASSEMBLY, FABRICATION CRITERIA AND TOLERANCES

#### .1 Mild Steel and Stainless Steel

All plates shall be cut and drilled using high precision equipment to give a manufacturing tolerance of +/-1.0mm maximum.

#### .2 Overall Tolerances

Parameter	Requirement
External Height Dimensions	+/- 5.0mm
Flatness of Exterior Top and Bottom	+/- 1.0mm
Variation from plane parallel to the theoretical top surface	Slope relative to the bottom no more than 0.005 radians

#### .3 Corrosion Protection

Corrosion protection to exposed mild steel surfaces is to be to AS/NZS 2312 to the design life specified in this specification. Colour shall be to Architect’s requirements.



## **.4 Assembly and Identification**

Mounting plates shall be fitted to devices as shown in the Drawings prior to packaging and delivery.

Each device will be permanently marked with an approved manufacturer's identification plate or punched letters on the side of the mounting plate in 10mm high letters. The marking will consist of device number, date of fabrication, and device type.

## **SI-01.5 PROTOTYPE TESTING**

### **.1 Prototype Tests**

Prototype tests shall be performed on two full-size specimens of each type of device in the isolation system. These tests are to verify the deformation characteristics, energy dissipation characteristics and the stability of the devices at the design and maximum displacements. Required prototype tests are defined by EN 15129:2009 *[or additional specified tests]*. Vertical load cases and values are as defined in SI-01.1.

The prototype devices are not to be used in the building, and shall be delivered to the client or disposed of at the client's or Engineer's direction.

If the prototype tests fail to meet the specified acceptance criteria those devices and tests will be rejected and the contractor will be required to modify the design, then manufacture and test replacement prototype bearings verified as complying with the design criteria described in this specification.

### **.2 Scaled Testing**

Scaled specimen testing or testing of samples of sliding elements may be acceptable alternatives to full scale testing provided:

- The average pressure on the sliding surface is the same for the scale model.
- The average speed of the puck over the concave surface for the duration of the test is the same.
- The total distance covered by the puck over the concave surface is the same or greater than the full scale test.

Details of any scaled testing or testing of samples must be submitted with the tender and acceptance will be at the Engineer's discretion.

### **.3 Acceptance Criteria**

The performance of a prototype shall be deemed adequate if the criteria defined in *[EN 15129:2009 or alternative criteria as follows]*.

### **.4 Testing of Similar Devices**

Test results from a device of similar size and type and using similar materials using the specified sequence of tests may be accepted as a prototype. The results of these tests are to be supplied as outlined in SI-01.2. Whether or not the results of these tests are an acceptable alternative to prototype testing shall be at the discretion of the Engineer. The acceptance criteria for testing of similar units shall be per SI-01.4.3. An example of what would be considered to be a similar device is as follows:

- Design displacement of the new device (for use in this project) is within +/- 20% of the design value used in previous tests.
- Design coefficients of friction are identical for the similar device and the new device.
- Basic materials for the sliding surface are identical for the similar device and new device.
- The effective radius of curvature of the new device is within +/-20% of the design value used in previous tests.
- The vertical load capacity of the new device is within +/-20% of the design value used in previous tests.

## SI-01.6 PRODUCTION TESTING

### .1 Production Tests

Quality control testing of production devices shall be carried out to provide assurance that the performance of production devices is within specified tolerances. The testing program shall be defined in accordance with [EN 15129:2009].

*[Design engineer to identify percentage of production total, not less than 20% but depending on circumstances]* of all devices are to be production tested. Should any production tests fail, testing will increase to 100% of all units until instructed by the Engineer.

The Engineer and/or Independent Engineer shall be present during the testing processes.

All units are to be fully inspected at the completion of manufacture and testing for signs of damage.

### .2 Acceptance Criteria

The performance of a test specimen shall be deemed adequate if the criteria set out in [EN 15129:2009] are satisfied, including that no defects are found on inspection after testing.

## SI-02 – ELASTOMERIC ISOLATORS (INCLUDING LEAD RUBBER BEARINGS)

### SI-02.0 INDEX

SI-02.1	Design Criteria
SI-02.2	Submittals
SI-02.3	Materials
SI-02.4	Assembly and Fabrication Criteria and Tolerances
SI-02.5	Prototype Device Testing
SI-02.6	Production Device Testing

### SI-02.1 DESIGN CRITERIA

Design Criteria for the Seismic Isolation System shall be as specified on the Structural Drawings and in accordance with the Table below. *[Amend Table and numbers to suit project.]*

Parameter	Overall System Behaviour
ULS Period (sec)	[2.5] sec
Design Displacement (at Centre of Mass)	[+/- 250] mm
Total Design Displacement (including allowance for torsion)	[+/- 300] mm
CALS Period (sec)	[2.8] sec
Maximum Displacement (at Centre of Mass)	[+/- 450] mm
Total Maximum Displacement (including allowance for torsion)	[+/- 500] mm

Design criteria for each device type shall be as specified on the Structural Drawings and in accordance with the Table below. The location of each of the device types is indicated on the Structural Drawings. *[Amend Table and numbers to suit project.]*

Parameter	Device Type		
	Type A	Type B	Type C
No. of Devices	#A	#B	#C
Yield force	100 kN	100 kN	100 kN
Pre-Yield stiffness ( $K_1$ )	10.0 kN/mm	10.0 kN/mm	10.0 kN/mm
Post-Yield stiffness ( $K_2$ )	1.00 kN/mm	1.00 kN/mm	1.00 kN/mm
Compression Stiffness	500 kN/mm	500 kN/mm	500 kN/mm
Minimum Effective Damping at Design Displacement (250mm)	30%	30%	30%
Average service axial load ( $G+\Psi Q$ )	1000 kN	1000 kN	1000 kN
Maximum ultimate axial load capacity ( $1.2G + 1.5Q$ )	1500 kN	1500 kN	1500 kN
Working axial load in earthquake ( $G+\Psi_e Q$ )	1000 kN	1000 kN	1000 kN
Maximum axial load in earthquake ( $G+\Psi_e Q+E_{ULS}$ )	2000 kN	2000 kN	2000 kN
Maximum axial load in earthquake ( $G+\Psi_e Q+E_{CALS}$ )	3000 kN	3000 kN	3000 kN
Minimum ( $G-E_{CALS}$ )	2G tension	2G tension	2G tension

Note that design loading combinations are defined as AS/NZS 1170. Effective damping is to be determined based on a method approved by the Design Engineer.

Prototype testing must remain within +/-20% of the Design Shear Force at Total Design Displacement as defined in this specification, or through the design process of the isolation system or device supplier.

## .1 Geometry

Geometry shall be generally as indicated on the Structural Drawings and summarised in the limits here. The supplier is to supply top and bottom plates as indicated in the Structural Drawings. The supplier is to provide top and bottom fixing plate templates for co-ordination of cast-in fixings and bolts.

Should the device design not comply with geometry indicated on the Structural Drawings and summarised below, the contractor shall submit the proposed geometry to the Engineer for approval.

Alternate geometry may require the Engineer to carry out reanalysis and/or re-documentation of the building structure including, by not limited to, the fixings to the basement columns and capitals as indicated on the Structural Drawings. Such reanalysis and/or re-documentation shall be at the contractor's expense.

Allowance shall be made for locating attachment/anchor bolts within the geometric constraints.

Parameter	
Plan shape	<i>[Square mounting plates / Circular elastomer]</i>
Diameter of supporting structure	[1000] mm
Maximum overall height (including fixing plates)	[450] mm

## .2 Allowable Bearing Pressures

The primary structure immediately above and below the isolation devices is able to carry a bearing pressure of *[50MPa (ULS)]*. The isolator supplier shall ensure that the isolators-structure interface does not exceed this bearing pressure under the axial loading given above. Additional bearing plates shall be provided by the isolation system supplier if necessary.

## .3 Design Life, Durability, Fire Resistance and Maintenance

The isolation system shall have a design life of *[100]* years as a primary structural component. All bearings are to be fully accessible to allow periodic maintenance. Periodic maintenance shall not be more regular than *[20]* years. A schedule of all requirements for maintenance shall be provided by the Contractor with the Final Report and Certification. An outline of the maintenance requirements shall be supplied with the tender.

## .4 Replacement

Isolation device top/bottom plates shall be designed to allow complete future removal and replacement without damaging the fixing system or immediate structure and without raising the adjacent structure more than 5mm.

## SI-02.2 SUBMITTALS

The Contractor shall undertake the work in five Phases as set out below. The Contractor shall not proceed to the next phase until all review comments have been satisfied unless explicitly notified in writing. Proceeding without this approval shall be at the contractor's risk.

### .1 Tender Submission

The following is required for the tender submittal:

- Summary of proposed component performance compared to each of the design criteria listed in SI-02.1
- Summary of properties of each device in the system including but not limited to initial stiffness, yield force and post-yield stiffness as relevant to the device type.
- Qualification data for similar devices manufactured and supplied by the contractor.
- Summary of testing apparatus (if possible annotated illustrations of all proposed test apparatus) and procedures for tests to demonstrate how the particular requirements of the specification are to be satisfied.
- Name, contact details, qualifications and experience of the proposed Independent Verification Engineer.
- Preliminary shop drawings of each component type indicating size of each device and its mounting plate, including indicative fixings.
- A summary of materials testing proposed including what testing will be project specific and what will be based on previous test data and/or other manufacturer's product specifications.
- Manufacturer's product specifications where utilised as above, including handling and assembly procedures.

- Outline maintenance schedule to achieve the design life.
- The proposed form of warranty.
- Proposed design, testing and production programme.
- Confirmation that the supplier can meet the project construction programme.

## **.2 Materials, Component and Process Design**

The following information is required at completion of design prior to manufacture of the prototypes:

- Shop drawings for each and every device type indicating:
  - All dimensions and weights
  - Arrangement of parts and their individual geometries
  - Method of assembly
  - Packaging and handling
  - Installation method and installation drawings including bolting templates
- Identification of what standards component materials are manufactured/fabricated to.
- Details of corrosion protection to be provided.
- Source and Quality Assurance information for all plate materials and bolts, including certification of manufacturer and/or personnel involved with any welding or machining processes.
- Certifications that all testing equipment has been checked for accuracy by appropriate standards (ASTM E4, etc.) for the purpose of this contract. Detailed annotated and drafted illustrations of all proposed test apparatus where not covered by the tender submission.

## **.3 Prototype Device Testing/Design Verification Submissions**

Submit a report including the following information for each test required under SI-01.4

- Date, time, temperature and test rig identification.
- Names of technicians operating the rig and all observers (Independent Verification Engineer etc.) present.
- Force vs. deflection plots for all tests.
- Force (or displacement) vs. time plots for all tests with horizontally applied loads.
- Force vs. velocity plots for all device tests involving horizontally applied loads.
- Photographs of devices where “inspection” is required in test procedure.
- Derivation of characteristics listed in design requirements.
- Comparison of results with target parameters.
- Interim data shall be made available to the observing team for discussion of results before the final report is issued to allow for adjustments to be made to the design or process if required.

## **.4 Production Device Test Submissions**

At the time of each production test submit a report including the following information for each test required by this specification.

- Date, time, temperature and test rig identification.
- Names of technicians operating the rig and all observers (Independent Verification Engineer etc.) present.
- Force (or displacement) vs. time plots for all tests with horizontally applied loads.
- Force vs. velocity plots for all device tests involving horizontally applied loads.
- Photographs of devices where “inspection” is required in test procedure.
- Derivation of characteristics listed in design requirements.
- Comparison of results with target parameters.
- Proposals for adjustments to materials to correct future production if necessary to achieve correct system response and for all devices produced since the previous production submission.
- Certified test reports demonstrating purity of materials as relevant.
- Certified mill test reports for all steel mounting plate and connecting plate materials and bolts.

## SI-02.3 MATERIALS

### .1 Component Materials

The supplier shall submit details of all component materials to the Engineer for review, along with identification of what standards the materials comply with. Device components include but are not necessarily limited to:

- The top and bottom plates.
- The rubber and metal shim layers.
- The lead core(s).

## SI-02.4 ASSEMBLY, FABRICATION CRITERIA AND TOLERANCES

### .1 Mild Steel and Stainless Steel

All plates shall be cut and drilled using high precision equipment to give a manufacturing tolerance of +/-1.0mm maximum.

### .2 Overall Tolerances

Parameter	Requirement
External Height Dimensions	+/- 5.0mm
Flatness of Exterior Top and Bottom	+/- 1.0mm
Variation from plane parallel to the theoretical top surface	Slope relative to the bottom no more than 0.005 radians

### .3 Corrosion Protection

Corrosion protection to exposed mild steel surfaces is to be to AS/NZS 2312 to the design life specified in this specification. Bearing colour shall be to Architect's requirements.

### .4 Assembly and Identification

Mounting plates shall be fitted to bearings as shown in the Drawings prior to packaging and delivery.

Each isolator will be permanently marked punched letters on the side of the mounting plate in 10mm high letters. The marking will consist of an isolator number, date of fabrication (month and year), and isolator type.

## SI-02.5 PROTOTYPE TESTING

### .1 Prototype Tests

Prototype tests shall be performed on two full-size specimens of each type of device in the isolation system. These tests are to verify the deformation characteristics, energy dissipation characteristics and the stability of the devices at the design and maximum displacements. Required prototype tests are defined by *[EN 15129:2009 or additional tests specified by the design engineer]*. Vertical load cases and values are as defined in SI-02.1.

The prototypes are not to be used in the building, and shall be delivered to the client or disposed of at the Clients or Engineer's direction.

If the prototype tests fail to meet the specified acceptance criteria those devices and tests will be rejected and the manufacturer will be required to modify the design, then manufacture and test replacement prototype devices verified as complying with the design criteria described in this specification.

### .2 Scaled Testing

Scaled specimen testing in accordance with criteria in *[EN 15129:2009]* may be acceptable at the Engineer's discretion.

### **.3 Acceptance Criteria**

The performance of a test specimen shall be deemed adequate if the criteria defined in [EN 15129:2009 or alternative criteria as follows].

### **.4 Testing of Similar Units**

The prototype tests are not required if an isolator unit is of similar size and of the same type and materials as a prototype isolator that has been previously tested using the specified sequence of tests. The results of these tests are to be supplied as outlined in SI-02.2. Whether or not the results of these tests are an acceptable alternative to prototype testing shall be at the discretion of the Engineer. The acceptance criteria for testing of similar units shall be per SI-02.4.3. An example of what would be considered to be a similar unit is as follows:

- Vertical load capacity of the new unit (for use in this project) is within +/- 20% of the design value used in previous tests.
- Design displacement of the new unit (for use in this project) is within +/- 20% of the design value used in previous tests.
- Design yield force is within +/- 10% of the design value used in previous tests.
- Basic materials for the device are identical for the similar unit and new unit.
- The bearing maximum shear force at Total Design Displacement for the new unit is within +/-20% of shear force developed at the same displacement in previous tests.
- The hysteretic energy dissipation of the new device is within +/-20% of the design value used in previous tests.

## **SI-02.6 PRODUCTION TESTING**

### **.1 Production Tests**

Production testing shall be carried as follows out to provide quality assurance to the manufacturing process and allow device stiffness to be refined if necessary. The testing program shall be defined in accordance with [EN 15129:2009].

[Design engineer to identify percentage of production total %, not less than 20% but depending on circumstances] of all production units are to be tested. Should any production tests fail, testing will increase to 100% of all units until instructed by the Engineer.

The Engineer and/or Independent Engineer shall be present during the testing processes.

All units are to be fully inspected at the completion of testing for signs of damage.

### **.2 Acceptance Criteria**

The performance of a test specimen shall be deemed adequate if the criteria set out in [EN 15129:2009] are satisfied, including that no defects are found on inspection after testing.

## SI-03 – FLAT SLIDER ISOLATORS

### SI-03.0 INDEX

SI-03.1	Design Criteria
SI-03.2	Submittals
SI-03.3	Materials
SI-03.4	Assembly and Fabrication Criteria and Tolerances
SI-03.5	Prototype Device Testing
SI-03.6	Production Device Testing

### SI-03.1 DESIGN CRITERIA

Design criteria for each device type shall be as specified on the Structural Drawings and in accordance with the Table below. The location of each of the device types is indicated on the Structural Drawings. *[Amend Table and numbers to suit project.]*

Parameter	Bearing Type		
	Type A	Type B	Type C
No. of Bearings	#A	#B	#C
Total Design Displacement (including allowance for torsion)	[+/- 300] mm	[+/- 300] mm	[+/- 300] mm
Total Maximum Displacement (including allowance for torsion)	[+/- 500] mm	[+/- 500] mm	[+/- 500] mm
Friction coefficient	[0.08 +/-] 20%	[0.08 +/-] 20%	[0.08 +/-] 20%
Minimum Effective Damping at Design Displacement (250mm)	30%	30%	30%
Average service axial load (G+ΨQ)	[1000] kN	[1000] kN	[1000] kN
Maximum ultimate axial load capacity (1.2G + 1.5Q)	[1500] kN	[1500] kN	[1500] kN
Maximum axial load in earthquake (G+ΨeQ+E <sub>ULS</sub> )	[2000] kN	[2000] kN	[2000] kN
Maximum axial load in earthquake (G+ΨeQ+E <sub>CALS</sub> )	[3000] kN	[3000] kN	[3000] kN

Note that design loading combinations are defined as AS/NZS 1170. Effective damping is to be determined based on a method approved by the Design Engineer.

#### .1 Geometry

Geometry shall be generally as indicated on the Structural Drawings and summarised in the limits here. The supplier is to supply top and bottom plates as indicated in the Structural Drawings. The supplier is to provide top and bottom fixing plate templates for co-ordination of cast in fixings and bolts.

Should the unit design not comply with geometry indicated on the Structural Drawings and summarised below, the contractor must submit the proposed geometry to the Engineer for approval.

Alternate geometry may require the Engineer to carry out reanalysis and/or re-documentation of the building structure including, by not limited to, the fixings to the basement columns and capitals as indicated on the Structural Drawings. Such reanalysis and/or re-documentation shall be at the Contractor's expense.



Allowance shall be made for locating attachment/anchor bolts within the geometric constraints.

Parameter	Requirement
Plan shape	[Square/Circular]
Diameter of supporting structure	[1000] mm
Maximum overall height (including fixing plates)	[250] mm

## .2 Allowable Bearing Pressures

The primary structure immediately above and below the units is able to carry a bearing pressure of [50MPa (ULS)]. The isolator supplier shall ensure that the device-structure interface does not exceed this bearing pressure under the axial loading given above. Additional bearing plates shall be provided by the device supplier if necessary.

## .3 Design Life, Durability, Fire Resistance and Maintenance

The bearing system shall have a design life of [100] years as a primary structural component. All bearings are to be fully accessible to allow periodic maintenance. Periodic maintenance shall not be more regular than [20] years. A schedule of all requirements for maintenance shall be provided by the Contractor with the Final Report and Certification. An outline of the maintenance requirements shall be supplied with the tender.

## .4 Replacement

Top/bottom plates shall be designed to allow complete future device removal and replacement without damaging the fixing system or immediate structure and without raising the adjacent structure more than 5mm.

### SI-03.2 SUBMITTALS

The Contractor shall undertake the work in five Phases as set out below. The Contractor shall not proceed to the next phase until all review comments have been satisfied unless explicitly notified in writing. Proceeding without this approval shall be at the contractor's risk.

#### .1 Tender Submission

The following is required for the tender submittal:

- Summary of proposed component performance compared to each of the design criteria listed in SI-03.1
- Summary of properties of each device in the system including initial stiffness, friction (as varies with speed and axial load) as relevant to the bearing type.
- Qualification data for similar devices manufactured and supplied by the contractor.
- Summary of testing apparatus (if possible annotated illustrations of all proposed test apparatus) and procedures for tests to demonstrate how the particular requirements of the specification are to be satisfied.
- Name, contact details qualifications and experience of the proposed Independent Verification Engineer.
- Preliminary shop drawings of each component type indicating size of each device and its mounting plate, including indicative fixings.
- A summary of materials testing proposed including what testing will be project specific and what will be based on previous test data and/or other manufacturer's product specifications.
- Manufacturer's product specifications where utilised as above, including handling and assembly procedures.
- Outline maintenance schedule to achieve the design life.
- The proposed form of warranty.
- Proposed design, testing and production programme.
- Confirmation that the supplier can meet the project construction programme.

## **.2 Materials, Component and Process Design**

The following information is required at completion of design prior to manufacture of the prototypes:

- Shop drawings for each and every device type indicating:
  - All dimensions and weights
  - Arrangement of parts and their individual geometries
  - Method of assembly
  - Packaging and handling
  - Installation method and installation drawings including bolting templates
- Identification of what standards component materials are manufactured/fabricated to.
- Details of corrosion protection to be provided.
- Source and Quality Assurance information for all plate materials and bolts, including certification of manufacturer and/or personnel involved with any welding or machining processes.
- Certifications that all testing equipment has been checked for accuracy by appropriate standards (ASTM E4, etc.) for the purpose of this contract. Detailed annotated and drafted illustrations of all proposed test apparatus where not covered by the tender submission

## **.3 Prototype Testing/Design Verification Submissions**

Submit a report including the following information for each test required under SI-03.4

- Date, time, temperature and test rig identification.
- Names of technicians operating the rig and all observers (Independent Verification Engineer etc.) present.
- Force vs. deflection plots for all tests.
- Force (or displacement) vs. time plots for all tests with horizontally applied loads.
- Force vs. velocity plots for all tests involving horizontally applied loads.
- Photographs of devices where “inspection” is required in test procedure.
- Derivation of characteristics listed in design requirements.
- Comparison of results with target parameters.
- Interim data shall be made available to the observing team for discussion of results before the final report is issued to allow for adjustments to be made to the design or process if required.

## **.4 Production Submissions**

At the time of each production test submit a report including the following information for each test required by this specification.

- Date, time, temperature and test rig identification.
- Names of technicians operating the rig and all observers (Independent Verification Engineer etc.) present.
- Force vs. deflection plots for all tests.
- Force (or displacement) vs. time plots for all tests with horizontally applied loads.
- Force vs. velocity plots for all tests involving horizontally applied loads.
- Photographs of devices where “inspection” is required in test procedure.
- Derivation of characteristics listed in design requirements.
- Comparison of results with target parameters.
- Proposals for adjustments to materials to correct future production if necessary to achieve correct system response and for all devices produced since the previous production submission.
- Certified test reports demonstrating purity of materials as relevant.
- Certified mill test reports for all steel mounting plate and connecting plate materials and bolts.

### SI-03.3 MATERIALS

#### .1 Component Materials

The supplier shall submit details of all component materials to the Engineer for review, along with identification of what standards the materials comply with. Bearing components include but are not necessarily limited to:

- The top and bottom plates.
- The plate liners.
- The puck.
- The puck coating.
- Bearing plates.

### SI-03.4 ASSEMBLY, FABRICATION CRITERIA AND TOLERANCES

#### .1 Mild Steel and Stainless Steel

All plates shall be cut and drilled using high precision equipment to give a manufacturing tolerance of +/-1.0mm maximum.

#### .2 Overall Tolerances

Parameter	Requirement
External Height Dimensions	+/- 5.0mm
Flatness of Exterior Top and Bottom	+/- 1.0mm
Variation from plane parallel to the theoretical top surface	Slope relative to the bottom no more than 0.005 radians

#### .3 Corrosion Protection

Corrosion protection to exposed mild steel surfaces is to be to AS/NZS 2312 to the design life specified in this specification. Bearing colour shall be to Architect's requirements.

#### .4 Assembly and Identification

Mounting plates shall be fitted to bearings as shown in the Drawings prior to packaging and delivery.

Each isolator will be permanently marked punched letters on the side of the mounting plate in 10mm high letters. The marking will consist of an isolator number, date of fabrication (month and year), and isolator type.

### SI-03.5 PROTOTYPE BEARING TESTING

#### .1 Prototype Tests

Prototype tests shall be performed on two full-size specimens of each type of device in the isolation system. These tests are to verify the deformation characteristics, energy dissipation characteristics and the stability of the devices at the design and maximum displacements. Required prototype tests are defined by *[EN 15129:2009 or additional tests specifics as defined by the design engineer]*. Vertical load cases and values are as defined in SI-03.1.

The prototypes are not to be used in the building, but if required delivered to the Client or disposed of at the Client's or Engineer's direction.

If the prototype tests fail to meet the specified acceptance criteria those bearings and tests will be rejected and the manufacturer will be required to modify the design, then manufacture and test replacement prototype bearings verified as complying with the design criteria described in this specification.

All testing shall be carried out in an atmosphere maintained at a uniform temperature between 15-23° C.

## .2 Scaled Testing

Scaled specimen testing or testing of samples of sliding elements may be acceptable alternatives to full scale testing provided:

- The average pressure on the sliding surface is the same for the scale model
- The average speed of the puck over the concave surface for the duration of the test is the same.
- The total distance covered by the puck over the concave surface is the same or greater than the full scale test.

Details of any scaled testing or testing of samples must be submitted with the tender and will be acceptable at the Engineer's discretion.

## .3 Acceptance Criteria

- The performance of a test specimen shall be deemed adequate if the criteria defined in *[EN 15129:2009 or the following criteria based on specific test program definitions are satisfied]*.

## .4 Testing of Similar Units

The prototype tests are not required if a device of similar size and of the same type and materials as a prototype isolator that has been previously tested using the specified sequence of tests. The results of these tests are to be supplied as outlined in SI-03.2. Whether or not the results of these tests are an acceptable alternative to prototype testing shall be at the discretion of the Engineer. The acceptance criteria for testing of similar devices shall be per SI-03.4.3. An example of what would be considered to be similar is as follows:

- Design displacement of the new unit (for use in this project) is within +/- 20% of the design value used in previous tests.
- Design isolation period is within +/- 20% of the design value used in previous tests.
- Design coefficients of friction are identical for the similar unit and the new unit.
- Basic materials for the sliding surface are identical for the similar unit and new unit.
- The vertical load capacity of the new device is within +/-20% of the design value used in previous tests.

## SI-03.6 PRODUCTION TESTING

### .1 Production Tests

Production testing shall be carried as follows out to provide quality assurance to the manufacturing process and allow device stiffness to be refined if necessary. The testing program shall be defined by *[refer to EN 15129:2009]*.

*[Design engineer to identify percentage of production total %, not less than 20% but depending on circumstances]* of all production units are to be tested. Should any production tests fail, testing will increase to 100% of all units until instructed by the Engineer.

The Engineer and/or Independent Engineer shall be present during the testing processes.

All units are to be fully inspected at the completion of testing for signs of damage.

### .2 Acceptance Criteria

The performance of a test specimen shall be deemed adequate if the criteria set out in *[EN 15129:2009]* are satisfied, including that no defects are found on inspection after testing.

## SI-04 VISCOUS DAMPER DEVICES

### SI-04.0 INDEX

SI-04.1	Design Criteria
SI-04.2	Submittals
SI-04.3	Materials
SI-04.4	Assembly and Fabrication Criteria and Tolerances
SI-04.5	Prototype Testing
SI-04.6	Production Testing

### SI-04.1 DESIGN CRITERIA

The Design Criteria for the Viscous Damper Devices (VDD) shall be as specified on the Structural Drawings and in accordance with the Table below. The location of each of the damper types is indicated on the Structural Drawings.

*[Amend Table and numbers to suit project.]*

Parameter	Damper Type		
	Type A	Type B	Type C
No. of Dampers	#A	#B	#C
Performance Frequency (Hz)	[0.33]	[0.33]	[0.33]
Damping Coefficient (kN-s/m)	[2000]	[2000]	[2000]
Velocity exponent	[0.25]	[0.25]	[0.25]
Design Velocity (m/s)	[0.3]	[0.3]	[0.3]
Design Axial Force (kN)	[1500]	[2000]	[800]
Design displacement (+/- mm)	[300]	[300]	[300]
Wind Design Actions (+/- mm)	[6]	[6]	[6]
Thermal Design Actions (+/- mm)	[8]	[8]	[8]
VDD Lateral Design Acceleration (g)	[0.6]	[0.6]	[0.6]
VDD Axial Force with Lateral Design Acceleration (kN)	[1400]	[2000]	[900]

#### .1 Geometry

Geometry shall be generally as indicated on the Structural Drawings and summarised in the limits here. VDD units shall be supplied with required damper extenders, spherical end connections and mounting brackets.

The dampers, including all parts and accessories, shall be constructed and finished in a thoroughly workmanlike manner. Particular attention shall be given to neatness and thoroughness of soldering, wiring, making of parts and assemblies, welding, brazing, plating, finishes, riveting, machining and screw assemblies.

All parts shall be free of burrs and sharp edges and any damage, defect or foreign material which might detract for intended operation, function, or appearance of the unit.

Should the damper design not comply with geometry indicated on the Structural Drawings and summarised below, the contractor must submit the proposed geometry to the Engineer for approval.

Alternate geometry may require the Engineer to carry out reanalysis and/or re-documentation of the building structure including, by not limited to, the fixings to the primary structural frame as indicated on the Structural Drawings. Such reanalysis and/or re-documentation shall be at the Contractor's expense.

Allowance shall be made for locating attachment/anchor bolts within the geometric constraints.

## **.2 Maintenance Period**

The damper shall be designed and constructed to be maintenance free for a minimum of [50] years under anticipated service conditions. This means that no inspection, or fluid level verification, or refilling or replacement of fluid or any other part shall be required.

## **.3 Replacement**

Connections to the primary structure shall be designed to allow complete future damper removal and replacement without damaging the fixing system or immediate structure and without raising the adjacent structure more than 5mm.

### **SI-04.2 SUBMITTALS**

The Contractor shall undertake the work in five Phases as set out below. The Contractor shall not proceed to the next phase until all review comments have been satisfied unless explicitly notified in writing. Proceeding without this approval shall be at the contractor's risk.

#### **.1 Tender Submission**

The following is required for the tender submittal:

- Summary of proposed component performance compared to each of the design criteria listed in SI-04.1
- Summary of properties of each damper in the system.
- Qualification data for similar dampers manufactured and supplied by the contractor.
- Summary of testing apparatus (if possible annotated illustrations of all proposed test apparatus) and procedures for tests to demonstrate how the particular requirements of the specification are to be satisfied.
- Name, contact details, qualifications and experience of the proposed Independent Verification Engineer.
- Preliminary shop drawings of each component type indicating size of each damper and its mountings, incl. indicative fixings.
- A summary of materials testing proposed including what testing will be project specific and what will be based on previous test data and/or other manufacturer's product specifications.
- Manufacturer's product specifications where utilised as above, including handling and assembly procedures.
- Outline maintenance schedule to achieve the design life.
- The proposed form of warranty/collateral support.
- Proposed design, testing and production programme.
- Confirmation that the supplier can meet the project construction programme.

#### **.2 Materials, Component and Process Design**

The following information is required at completion of design prior to manufacture of the prototypes:

- Shop drawings for each and every damper type indicating:
  - All dimensions and weights
  - Arrangement of parts and their individual geometries
  - Method of assembly
  - Packaging and handling
  - Installation method and installation drawings including bolting templates
- Identification of what standards component materials are manufactured/fabricated to.
- Details of corrosion protection to be provided.
- Source and Quality Assurance information for all plate materials and bolts, including certification of manufacturer and/or personnel involved with any welding or machining processes.
- Certifications that all testing equipment has been checked for accuracy by appropriate standards (ASTM E4, etc.) for the purpose of this contract. Detailed annotated and drafted illustrations of all proposed test apparatus where not covered by the tender submission.

### **.3 Prototype Unit Testing/Design Verification Submissions**

Submit a report including the following information for each test required under SI-01.4

- Date, time, temperature and test rig identification.
- Names of technicians operating the rig and all observers (Independent Verification Engineer etc.) present.
- Force vs. deflection plots for all tests.
- Force (or displacement) vs. time plots for all tests with horizontally applied loads.
- Force vs. velocity plots for all dampers.
- Photographs of dampers where “inspection” is required in test procedure.
- Derivation of characteristics listed in design requirements.
- Comparison of results with target parameters.
- Interim data shall be made available to the observing team for discussion of results before the final report is issued to allow for adjustments to be made to the design or process if required.

### **.4 Production Unit Submissions**

At the time of each production test submit a report including the following information for each test required by this specification.

- Date, time, temperature and test rig identification.
- Names of technicians operating the rig and all observers (Independent Verification Engineer etc.) present.
- Force vs. deflection plots for all tests.
- Force (or displacement) vs. time plots for all tests with horizontally applied loads.
- Force vs. velocity plots for all damper tests.
- Photographs of dampers where “inspection” is required in test procedure.
- Derivation of characteristics listed in design requirements.
- Comparison of results with target parameters.
- Proposals for adjustments to materials to correct future production if necessary to achieve correct system response and for all bearings produced since the previous production submission.
- Certified test reports demonstrating purity of materials as relevant.
- Certified mill test reports for all steel mounting plate and connecting plate materials and bolts

## SI-04.3 MATERIALS

### .1 Component Materials

The supplier shall submit details of all component materials to the Engineer for review, along with identification of what standards the materials comply with.

## SI-04.4 ASSEMBLY, FABRICATION CRITERIA AND TOLERANCES

### .1 Connection to the Primary Structure

All bolted connections to the primary structure shall be to a tolerance of +/- 1 mm. All pin connections shall be to a tolerance of +/- 0.5 mm.

### .2 Corrosion Protection

Corrosion protection to exposed mild steel surfaces is to be to AS/NZS 2312 to the design life specified in this specification. Bearing colour shall be to Architect's requirements.

### .3 Assembly and Identification

Each damper will be permanently marked punched letters on the side of the main cylinder in 10mm high letters. The marking will consist of a damper number, date of fabrication (month and year), and damper type.

## SI-04.5 PROTOTYPE UNIT TESTING

### .1 Prototype Unit Tests

Prototype tests shall be performed on two full-size specimens of each type of damper in the structure. These tests are to verify the force-velocity characteristics, energy dissipation characteristics and the stability of the dampers at the design and maximum displacements. Required prototype tests are defined by *[EN 15129:2009 or additional tests specific as defined by the design engineer]*.

The prototypes are not to be used in the building, but if required delivered to the Client or disposed of at the Clients or Engineer's discretion.

If the prototype tests fail to meet the specified acceptance criteria those dampers and tests will be rejected and the manufacturer will be required to modify the design, then manufacture and test replacement prototype units verified as complying with the design criteria described in this specification.

### .2 Acceptance Criteria

The performance of a test specimen shall be deemed adequate if the criteria defined in *[EN 15129:2009 or the following criteria based on specific test program definitions]* are satisfied.

### .3 Testing of Similar Units

Prototype testing shall be undertaken whenever a new product has a load capacity differing by more than  $\pm 20\%$  from that of a previously tested unit and/or its design velocity is higher. For previous tests to be valid, the conceptual design and materials shall be used as before and the damping coefficient shall not differ by more than  $\pm 20\%$  and the velocity exponent shall be equal to that specified.



## SI-04.6 PROTOTYPE UNIT TESTING

### .1 Production Tests

Production testing shall be carried as follows out to provide quality assurance to the manufacturing process and allow damper properties to be refined if necessary. The testing program shall be defined in accordance with [EN 15129:2009].

*[Design engineer to identify percentage of production total]* of all units are to be production tested. Should any production tests fail, testing will increase to 100% of all units until instructed by the Engineer.

The Engineer and/or Independent Engineer shall be present during the testing processes.

All units are to be fully inspected at the completion of testing for signs of damage.

### .2 Acceptance Criteria

The performance of a test specimen shall be deemed adequate if the criteria set out in [EN 15129:2009] are satisfied, including that no defects are found on inspection after testing.

